

i n v e n t

hp color LaserJet
2550 series

use

hp color LaserJet 2550 series printer

User Guide _____

Copyright and License

© 2004 Copyright Hewlett-Packard Development Company, LP

Reproduction, adaptation, or translation without prior written permission is prohibited, except as allowed under the copyright laws.

The information contained in this document is subject to change without notice.

The only warranties for HP products and services are set forth in the express warranty statements accompanying such products and services. Nothing herein should be construed as constituting an additional warranty. HP shall not be liable for technical or editorial errors or omissions contained herein.

Part number Q3702-90952

Edition 1, 6/2004

Trademark Credits

Adobe Photoshop® and PostScript are trademarks of Adobe Systems Incorporated.

CorelDRAW™ is a trademark or registered trademark of Corel Corporation or Corel Corporation Limited.

Microsoft®, Windows®, MS-DOS®, and Windows NT® are U.S. registered trademarks of Microsoft Corporation.

Netscape™ and Netscape Navigator™ are U.S. trademarks of Netscape Communications Corporation.

TrueType™ is a U.S. trademark of Apple Computer, Inc.

UNIX® is a registered trademark of The Open Group.

ENERGY STAR® and the ENERGY STAR logo® are U.S. registered marks of the United States Environmental Protection Agency. Details on the proper use of the marks are explained in the "Guidelines for Proper use of the ENERGY STAR® Name and International Logo."



HP customer care

Online services

for 24-hour access to information by using a modem or Internet connection

World Wide Web: Updated HP printer software, product and support information, and printer drivers in several languages can be obtained from <http://www.hp.com/support/clj2550>. (The site is in English.)

Online troubleshooting tools

HP Instant Support Professional Edition (ISPE) is a suite of web-based troubleshooting tools for desktop computing and printing products. ISPE helps you quickly identify, diagnose, and resolve computing and printing problems. The ISPE tools can be accessed from <http://instantsupport.hp.com>.

Telephone support

Hewlett-Packard provides free telephone support during the warranty period. When you call, you will be connected to a responsive team that is waiting to help you. For the telephone number for your country/region, see the flyer that came in the box with the product, or visit <http://www.hp.com/support/callcenters>. Before calling HP, have the following information ready: product name and serial number, date of purchase, and description of the problem.

You can also find support on the Internet at <http://www.hp.com>. Click the **support & drivers** block.

Software utilities, drivers, and electronic information

Go to http://www.hp.com/go/clj2550_software. (The site is in English, but printer drivers can be downloaded in several languages.)

For information over the telephone, see the flyer that came in the box with the printer.

HP direct ordering for accessories or supplies

Order supplies from the following websites:

United States: <http://www.hp.com/sbso/product/supplies>

Canada: <http://www.hp.ca/catalog/supplies>

Europe: <http://www.hp.com/supplies>

Asia-Pacific: <http://www.hp.com/paper/>

Order accessories from <http://www.hp.com/accessories>. For more information, see [Accessories and ordering information](#).

To order supplies or accessories over the telephone, call the following numbers:

United States: (1) (800) 538-8787

Canada: (1) (800) 387-3154

To find the phone numbers for other countries/regions, see the flyer that came in the box with the printer.

HP service information

To locate HP-Authorized Dealers in the United States or Canada, call (1) (800) 243-9816 (United States) or (1) (800) 387-3867 (Canada). Or, go to <http://www.hp.com/go/cposupportguide>.

For service for your HP product in other countries/regions, call the customer support number for your country/region. See the flyer that came in the box with the printer.

HP service agreements

Call: 1-800-HPINVENT [(1) (800) 474-6836 (U.S.)] or (1) (800) 268-1221 (Canada).

Out-of-Warranty Service: (1) (800) 633-3600.

Extended Service: Call 1-800-HPINVENT [(1) (800) 474-6836 (U.S.)] or (1) (800) 268-1221 (Canada). Or, go to the HP Supportpack and Carepaq™ Services Web site at <http://www.hpexpress-services.com/10467a>.

HP Toolbox

To check the printer status and settings and to view troubleshooting information and online documentation, use the HP Toolbox software. You can view the HP Toolbox when the printer is directly connected to your computer or when it is connected to a network. You must have performed a complete software installation to use the HP Toolbox. See [Managing the printer](#).

Table of contents

1 Printer basics

Quick access to printer information	2
User guide links	2
Where to look for more information	2
Printer configurations	4
HP color LaserJet 2550L	4
HP color LaserJet 2550Ln	4
HP color LaserJet 2550n	5
Printer features	6
Printer parts	9
Interface ports	9
Software	11
Software and supported operating systems	11
Software tips	12
Software for Windows	12
Software for Macintosh	14
Uninstalling the printing software	14
Print-media specifications	17
General guidelines	17
Paper and print media	17
Printing and storage environment	18
Envelopes	18
Labels	20
Transparencies	20
Supported media weights and sizes	21

2 Control panel

Control panel features	23
Understanding Supplies Status	24
Understanding Printer Status	24

3 Printing tasks

Loading trays	28
Loading tray 1	28
Loading optional tray 2	29
Loading optional tray 3	31
Controlling print jobs	33
About printing by Source versus by Type or Size	33
Maximizing print speed for letter-size paper	35
Gaining access to printer driver settings	35
Features in the printer driver	36
Selecting an output location	41
Printing on special media	42
Printing on envelopes	42

Printing on labels	43
Printing on transparencies	44
Printing on glossy paper	45
Printing on HP LaserJet Tough paper	46
Printing on custom-sized print media or cardstock	46
Printing on letterhead or preprinted forms	47
Printing on both sides (duplexing manually)	48
To duplex manually	48
Canceling a print job	50

4 Managing the printer

Special pages	52
Demo page	52
Configuration page	52
Supplies Status page	53
HP Toolbox	55
Supported operating systems	55
Supported browsers	55
To view the HP Toolbox	56
Status tab	56
Troubleshooting tab	56
Alerts tab	57
Documentation tab	58
Device Settings window	58
Other links	59

5 Color

Using color	62
HP ImageREt 2400	62
Media selection	62
Color options	62
Standard red-green-blue (sRGB)	62
Managing color options	64
Print in Grayscale	64
Automatic versus Manual color adjustment	64
Manual color options	64
Matching colors	66

6 Maintenance

Managing supplies	68
Supplies life	68
Checking and ordering supplies	68
Storing supplies	69
Replacing and recycling supplies	69
HP policy on non-HP supplies	70
HP fraud hotline	70
Cleaning the printer	71
To clean the engine	71
Calibrating the printer	72
To calibrate the printer at the printer	72
To calibrate the printer from the HP Toolbox	72

7 Problem solving

Resolving problems that did not generate messages	74
Troubleshooting checklist	74
Checking the network	76
Solving general printing problems	77
Solving PostScript (PS) errors	82
Solving common Macintosh problems	83
Resolving problems that generated messages	89
Messages for both Windows and Macintosh	89
Messages for Windows only	89
Resolving the control panel messages	91
Supplies Status lights	92
Printer Status lights	95
Secondary light patterns for Printer Status lights	98
Clearing jams	99
Where to look for jams	99
To clear jams from inside the printer	99
To clear jams from input areas	100
To clear jams from output areas	102
Solving print-media problems	104
Solving print-quality problems	105
Print-quality checklist	105
Solving issues with all printed documents	105
Solving issues with color documents	114

Appendix A Accessories and ordering information

Supplies	120
Memory	121
Cable and interface accessories	122
Paper handling accessories	123
Paper and other print media	124
User-replaceable parts	126
Supplementary Documentation	127

Appendix B Service and support

Hewlett-Packard limited warranty statement	129
Print Cartridge Limited Warranty Statement	131
Availability of support and service	132
HP maintenance agreements	132
Onsite service agreements	132
HP Express Exchange (U.S. and Canada only)	133
To use HP Express Exchange	133
Repacking the printer	134
To repack the printer	134
Service information form	136

Appendix C Specifications

Printer specifications	137
------------------------------	-----

Appendix D Regulatory information

Introduction	139
FCC regulations	140

Environmental Product Stewardship program	141
Protecting the environment	141
Ozone production	141
Energy consumption	141
HP LaserJet printing supplies	141
Material safety data sheet	143
Declaration of conformity	144
Country-/region-specific safety statements	145
Laser safety statement	145
Canadian DOC statement	145
Korean EMI statement	145
Finnish laser statement	146

Appendix E Working with memory

Printer memory	148
Installing memory and font DIMMs	149
To install memory and font DIMMs	149
Checking DIMM installation	151
To check DIMM installation	151
Enabling memory	152
To enable memory for Windows	152
To enable memory for Mac OS	152
Enabling the language-font DIMM	153
To enable fonts for Windows	153

Index

1

Printer basics

This section provides information about the following topics:

- [Quick access to printer information](#)
- [Printer configurations](#)
- [Printer features](#)
- [Printer parts](#)
- [Software](#)
- [Print-media specifications](#)

Quick access to printer information

User guide links

- [Printer parts](#)
- [Control panel features](#)
- [Problem solving](#)

Where to look for more information

Several references are available for use with this printer. See <http://www.hp.com/support/clj2550>.

Setting up the printer

Getting started guide—Provides step-by-step instructions for installing and setting up the printer.

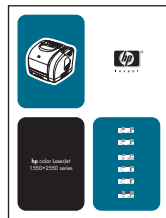

HP Jetdirect Administrator's Guide—Contains instructions to configure and troubleshoot the HP Jetdirect print server. This guide is included with printers that come with an HP Jetdirect print server.

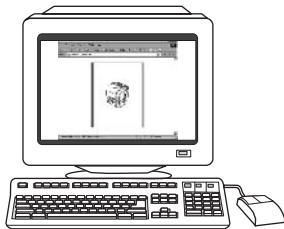

Accessory and supplies installation guides—These guides provide step-by-step instructions for installing the printer accessories and supplies.



Using the printer

User guide—Contains detailed information for using the printer and troubleshooting problems. This guide is available on the CD-ROM that came with the printer. It is also available through the HP Toolbox software.



Online Help—Contains information about printer options that are available from within the printer drivers. To view a Help file, open the online Help through the printer driver.

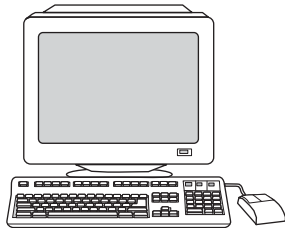

HTML (online) user guide—Contains detailed information for using the printer and troubleshooting problems. Go to <http://www.hp.com/support/clj2550>. After connecting, select **Manuals**.

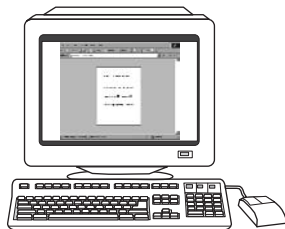

Printer configurations

Thank you for purchasing the HP color LaserJet 2550 series printer. The printer is available in the following configurations.

HP color LaserJet 2550L

The HP color LaserJet 2550L printer is a four-color laser printer that prints letter-size pages up to 20 pages per minute (ppm) in black and white, A4-size pages up to 19 ppm, and it prints letter/A4-size pages at 4 ppm in color. It includes a PCL 6 printer driver and has PostScript® level 3 emulation.



- **Trays.** The printer comes with a multipurpose tray (tray 1) that holds up to 125 sheets of various print media or 10 envelopes. The printer can also accept an optional 250-sheet tray (tray 2) for standard sizes and optional 500-sheet tray (tray 3) for A4 and letter sizes. (Optional tray 2 must be installed in order to install optional tray 3.) See [Supported media weights and sizes](#) for more information.
- **Print cartridges.** This model comes standard with color print cartridges (cyan, yellow, and magenta) that can print up to 2,000 pages at 5 percent coverage. It comes with a black print cartridge that can print up to 5,000 pages at 5 percent coverage. (A typical business letter has 5 percent coverage.)
- **Connectivity.** The printer provides parallel and universal serial bus (USB) ports for connectivity. The printer also accepts an optional HP Jetdirect external print server for connecting to a network.
- **Memory.** The printer comes standard with a 64-megabyte (MB) random access memory (RAM).
- **Expandability.** The printer has one available DIMM slot for memory expansion and additional font support. The memory is expandable to 192 MB by adding a 128-MB DIMM.

HP color LaserJet 2550Ln

The HP color LaserJet 2550n printer has the same features as the HP color LaserJet 2550L printer, except it *includes* an HP Jetdirect internal print server for connecting to a 10/100Base-T network. This model also accepts optional tray 2 and optional tray 3. (Optional tray 2 must be installed in order to install optional tray 3.)



HP color LaserJet 2550n

The HP color LaserJet 2550n printer has the same features as the HP color LaserJet 2550Ln printer and also includes tray 2. This model also accepts optional tray 3. This model comes standard with high-capacity color print cartridges that can print up to 4,000 pages.



Printer features

Feature	HP color LaserJet 2550 series printer
Color printing	<ul style="list-style-type: none"> ● Provides laser printing in full color by using the four process colors: cyan, magenta, yellow, and black (CMYK).
Fast print speed	<ul style="list-style-type: none"> ● Prints in black on letter-size paper up to 20 ppm and on A4-size paper up to 19 ppm. Prints in color on A4/letter at 4 ppm.
Excellent print quality	<ul style="list-style-type: none"> ● ImageREt 2400 provides 2400 dpi color and laser-class quality through a multilevel printing process. ● True 600 by 600 dots per inch (dpi) text and graphics. ● Adjustable settings to optimize print quality. ● The HP UltraPrecise print cartridge has a finer toner formulation that provides sharper text and graphics.
Ease of use	<ul style="list-style-type: none"> ● Few supplies to order. Supplies are easy to install. ● Convenient access to printer information and settings by using the HP Toolbox software. ● Convenient access to all supplies and to the paper path through the front door.
Expandability	<ul style="list-style-type: none"> ● Optional tray 2. (Included with the 2550n model; compatible with all other models.) This 250-sheet tray for standard sizes reduces how often you have to add paper to the printer. Only one 250-sheet tray can be installed on the printer. ● Optional tray 3. This 500-sheet tray for letter and A4 sizes reduces how often you have to add paper to the printer. Only one 500-sheet tray can be installed on the printer. Optional tray 2 must be installed in order to install optional tray 3. ● Optional HP Jetdirect external print server for connecting to a network (HP color LaserJet 2550L printer). ● One DIMM slot for adding memory and fonts.

Feature	HP color LaserJet 2550 series printer
Flexible paper handling	<ul style="list-style-type: none"> ● Adjustable tray 1 (multipurpose tray) for letterhead, envelopes, labels, transparencies, custom-sized media, postcards, glossy paper, HP LaserJet Tough paper, and heavy paper. ● Optional tray 2 (250-sheet tray) that is adjustable for several standard sizes of paper. ● Optional tray 3 (500-sheet tray) for letter- and A4-size paper. (Optional tray 2 must be installed in order to install optional tray 3.) ● One 125-sheet output bin and one output door. Select the top output bin (face down) for most jobs, including transparencies. Use the rear output door (face up) for jobs on heavy paper, light paper, or special print media. ● Straight-through paper path capability from tray 1 to the rear output door. ● Manual two-sided printing (duplexing). See Printing on both sides (duplexing manually).
Printer driver features	<ul style="list-style-type: none"> ● Fast printing performance, built-in Intellifont and TrueType™ scaling technologies, built-in HP-GL/2 vector graphics, and advanced imaging capabilities are benefits of the PCL 6 printer language. The PCL 6 also includes 45 scalable TrueType fonts and one bitmapped Line Printer Font. The PCL 6 printer language also included.
PostScript® (PS) level 3 emulation language and fonts	<ul style="list-style-type: none"> ● Includes 35 built-in PS language fonts.
Automatic language-switching	<ul style="list-style-type: none"> ● The printer automatically determines and switches to the appropriate printer language (such as PS or PCL 6) for the print job.
Interface connections	<ul style="list-style-type: none"> ● Bidirectional enhanced capabilities port (ECP) type-B parallel port (IEEE-1284 compliant). ● High-speed USB port. ● Accepts an optional HP Jetdirect external print server (HP color LaserJet 2550L printer). The HP color LaserJet 2550Ln and 2550n printers include an HP Jetdirect internal print server.

Feature	HP color LaserJet 2550 series printer
Networking	<ul style="list-style-type: none"> ● Accepts an optional HP Jetdirect external print server (HP color LaserJet 2550L printer). The HP color LaserJet 2550Ln and 2550n printers include an HP Jetdirect internal print server. ● All common network protocols such as Ethernet, Token Ring, and LocalTalk are available by using an optional HP Jetdirect external print server. (The 2550Ln and 2550n models include an HP Jetdirect internal print server.)
Enhanced memory and memory expansion	<ul style="list-style-type: none"> ● The printer comes with 64 MB of memory and can be expanded to 192 MB by using the DIMM slot. Most documents can be printed with the standard amount of printer memory through the aid of Memory Enhancement technology (MEt). MEt automatically compresses data, virtually doubling the printer memory and accommodating more complex printing with available memory.
Energy savings	<ul style="list-style-type: none"> ● The printer automatically conserves electricity by substantially reducing power consumption when it is not printing. ● As an ENERGY STAR® partner, Hewlett-Packard Company has determined that this product meets ENERGY STAR® guidelines for energy efficiency. ENERGY STAR® is a U.S. registered service mark of the United States Environmental Protection Agency.
Economical printing	<ul style="list-style-type: none"> ● N-up printing (printing more than one page on a sheet) and two-sided printing using manual duplexing saves paper. See Printing multiple pages on one sheet of paper (N-up printing) and Printing on both sides (duplexing manually).
Supplies	<ul style="list-style-type: none"> ● A Supplies Status page with print cartridge and imaging drum gauges that show the supply levels that remain. For HP supplies only. ● No-shake cartridge design. ● Authentication for HP print cartridges. ● Enabled supplies-ordering capability.
Accessibility	<ul style="list-style-type: none"> ● Online user guide that is compatible with text screen-readers. ● Print cartridges and the imaging drum can be installed and removed by using one hand. ● All doors and covers can be opened by using one hand.

Printer parts

Before using the printer, familiarize yourself with the parts of the printer.

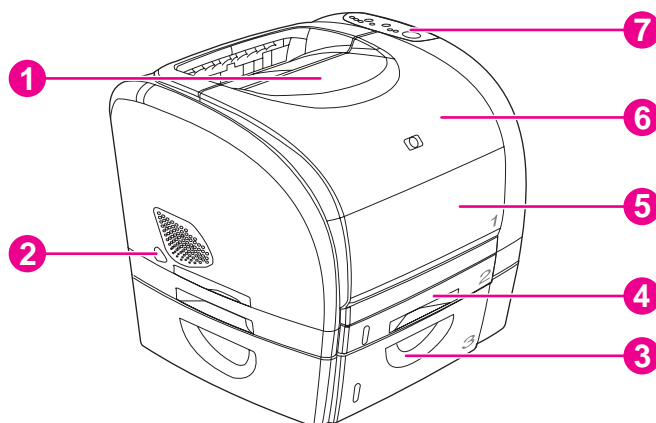

- 1 top (face-down) output bin
- 2 power switch
- 3 optional tray 3
- 4 optional tray 2 (included with HP color LaserJet 2550n model)
- 5 tray 1
- 6 top cover
- 7 control panel

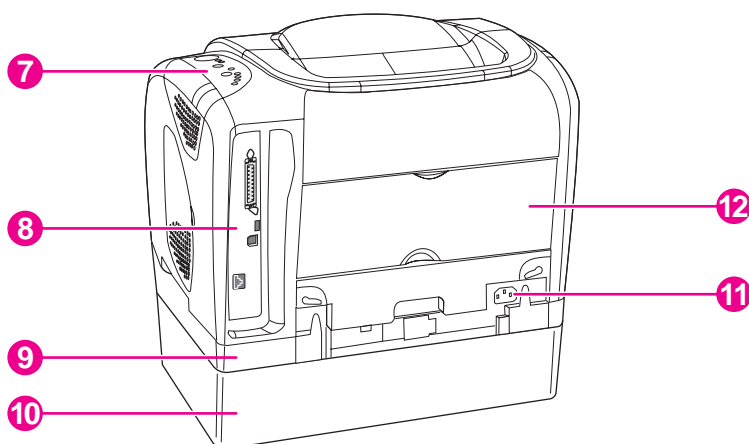

- 7 control panel
- 8 interface ports
- 9 optional tray 2
- 10 optional tray 3
- 11 power connector
- 12 rear (face-up) output door

Interface ports

The printer has two interface ports: an IEEE-1284B parallel port and a high-speed USB port.

The HP color LaserJet 2550Ln and 2550n models include an HP Jetdirect internal print server that contains a 10/100Base-T (RJ-45) port.

Note

Because an HP Jetdirect print server is not included with all models, it is referred to as the optional HP Jetdirect print server in this documentation.

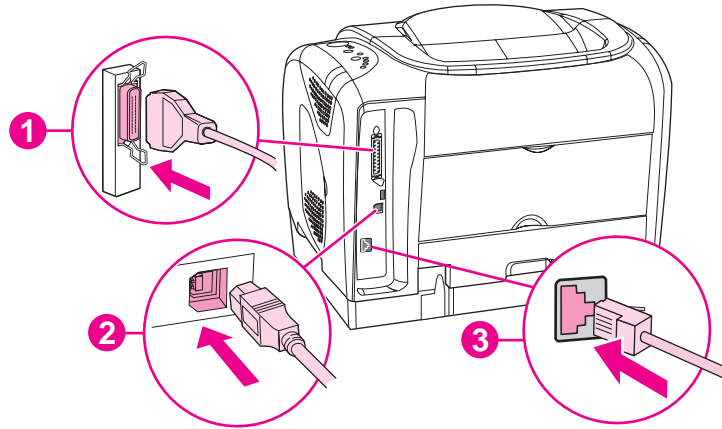

- 1 parallel port (IEEE-1284B)
- 2 high-speed USB port
- 3 10/100Base-T port (HP color LaserJet 2550Ln and 2550n printers only)

Software and supported operating systems

For easy printer setup and access to the full range of printer features, HP strongly recommends that you install the software that is provided. Not all software is available in all languages. See the getting started guide for installation instructions, and see the Readme file for the latest software information.

The most recent drivers, additional drivers, and other software are available from the Internet and other sources. If you do not have access to the Internet, see [HP customer care](#).

The printer supports the following operating systems:

- Microsoft® Windows® 98, Windows 2000, Windows Millennium Edition (Me), and Windows XP
- Windows NT 4.0 (driver only, other printer software is not available)
- Macintosh OS 9.1 and OS X v.10.1 and later
- UNIX®, Linux, and OS/2 (limited functionality)

The following tables list the software that is available for your operating system.

HP color LaserJet 2550 series printer software

Feature	Windows 98, Me	Windows 2000 and XP	Macintosh OS 9.1	Macintosh OS X	UNIX®, Linux	OS/2
Windows Installer	✓	✓				
PCL 6 printer driver	✓	✓				
PS printer driver	✓	✓				
HP Web Jetadmin software		✓ ₁				
HP Toolbox software	✓	✓		✓		
Macintosh Installer			✓	✓		
Macintosh PostScript printer description (PPD) and printer dialog extensions (PDE)			✓	✓		

HP color LaserJet 2550 series printer software (continued)

Feature	Windows 98, Me	Windows 2000 and XP	Macintosh OS 9.1	Macintosh OS X	UNIX®, Linux	OS/2
IBM drivers						✓ ₁
Model scripts					✓ ₂	

¹Available on the HP website.

²Available on the HP website. Not specific to this printer.

Software tips

The following are some tips for working with the printer software.

How do I gain access to the printer features?

The printer features are available in the printer driver. Some features such as custom paper sizes and page orientation might also be available in the program you are using to create a file. Change settings in the program, if possible, because changes that are made in the program override changes that are made in the printer driver.

Gain access to advanced printer features through the printer driver (or the **Print** dialog box for Macintosh operating systems). See [Gaining access to printer driver settings](#) for help with specific printer-driver features.

How do I get the latest printing software?

When you want to check for and install upgrades to the printing software, you can download drivers from the World Wide Web or HP's file transfer protocol (FTP) servers.

To download drivers

1. Go to <http://www.hp.com>. Click the **support & drivers** block.
2. Type `color laserjet 2550` as the product name. The Web page for the drivers might be in English, but you can download the drivers themselves in several languages.

If you do not have Internet access, contact HP Customer Care. (See [HP customer care](#) or the flyer that came in the printer box.) See the Readme file for additional release information.

What other software is available?

See the Readme file that is provided on the HP color LaserJet 2550 CD-ROM for additional, included software and for supported languages.

Software for Windows

When you install the software for Windows, you can directly connect the printer to a computer by using a USB or parallel cable or, if your printer is network-enabled, you can connect the printer to the network by using the HP Jetdirect print server. See the getting started guide for installation instructions, and see the Readme file for the latest software information.

The following software is available to all users of the printer, whether you connected the printer directly to a computer by using a parallel cable or USB cable, or whether you connected the printer to the network by using an HP Jetdirect print server.

Printer drivers

A printer driver is a software component that provides access to printer features and provides the means for the computer to communicate with the printer. For help using your printer driver, see [Gaining access to printer driver settings](#).

Select a printer driver based on the way you use the printer.

- Use the PCL 6 printer driver to take full advantage of the printer features. Unless complete backward compatibility with previous PCL drivers or older printers is necessary, the PCL 6 driver is recommended.
- Use the PostScript (PS) printer driver for compatibility with PS needs. Certain printer features are not available in this printer driver.

The printer automatically switches between PS 3 emulation and PCL printer languages depending on the driver you have selected.

Using Help

The printer driver has **Help** dialog boxes that can be activated from the **Help** button in the printer driver, the **F1** key on the computer keyboard, or the question mark symbol (?) in the upper-right corner of the printer driver. These **Help** dialog boxes give detailed information about the specific printer driver. Help for the printer driver is separate from the Help for your program.

HP Toolbox

You must perform a complete software installation to use the HP Toolbox.

The HP Toolbox provides links to printer status information and help information, such as this user guide; and tools for diagnosing and solving problems. You can also view explanations and animations of light messages on the control panel. See [Maintenance](#) for more information.

Software for network installations only

This software is available only when the printer is connected to a network.

HP Web Jetadmin

HP Web Jetadmin is intended for printer management in commercial and enterprise networks. While the HP Toolbox is used to manage a single printer, HP Web Jetadmin is used to manage groups of printers and other devices. Download this software from the HP website at <http://www.hp.com/go/webjetadmin>. The HP Web Jetadmin website provides HP Web Jetadmin software in many languages.

HP Web Jetadmin is available only if the printer is connected to an Internet protocol- (IP-) based network. This browser-based software can be installed on one of the following supported platforms:

- Microsoft Windows 2000 or XP
- Red Hat Linux
- SuSE Linux

Starting HP Web Jetadmin

After you install the HP Web Jetadmin software, you can start it in a supported Web browser on any computer by typing one of the following Web addresses:

- `http://server.domain:port/`

where "server.domain" is the server hostname and "port" is the port number that you selected during installation. (The default port is 8000.) This information is available in the `url.txt` file, which is stored in the folder where HP Web Jetadmin is installed.

- `http://ipaddress:port/`

where "ipaddress" is the IP address of the computer on which HP Web Jetadmin is installed.

For settings that appear in both the printer driver and HP Web Jetadmin, changes that are made in the printer driver override changes that are made in HP Web Jetadmin.

Software for Macintosh

For Mac 9.1, the Apple LaserWriter 8 driver must be installed to use the PPD file. Use the Apple LaserWriter 8 driver that came with your Macintosh. For Mac OS X, use Print Center to print.

The printer includes the following software for Macintosh computers.

PPDs (Mac OS 9.1 and Mac OS X classic)

PPDs, in combination with the LaserWriter driver, provide access to the printer features and allow the computer to communicate with the printer. An installation program for the PPDs is provided on the HP color LaserJet 2550 CD-ROM.

PDEs (Mac OS X)

PDEs are code plug-ins that provide access to printer features, such as information about the number of copies, two-sided printing, and quality settings. An installation program for the PDEs and other software is provided on the HP color LaserJet 2550 CD-ROM.

HP Toolbox

The HP Toolbox is supported for Mac OS 10.1 and later. You must perform a complete software installation to use the HP Toolbox. The HP Toolbox provides links to printer status information and help information, such as this user guide; and tools for diagnosing and solving problems. You can also view explanations and animations of light messages on the control panel. See [HP Toolbox](#) for more information.

Uninstalling the printing software

Uninstall software by using the following directions for your operating system.

Uninstalling software for Windows

The printer comes with an uninstall utility that you can use to select and remove any or all of the Windows HP printing system components from your computer.

To uninstall software for Windows 98 and later

Note

To uninstall the software from Windows 2000 or XP, you must log on with administrator privileges.

1. Close all of the open programs.

For Windows 98 and Me

- a. Press **Ctrl+Alt+Delete**. The **Close Program** dialog box opens.
- b. Select a program *except* Explorer or Systray, and click **End Task**.
- c. Repeat step b until all of the programs except Explorer and Systray are closed.

For Windows 2000 and XP

- a. Press **Ctrl+Alt+Delete**. The **Windows Security** dialog box opens.
- b. Click **Task Manager** and then click the **Applications** tab.
- c. Select a program, and then click **End Task**.
- d. Repeat step c until all of the programs are closed.
2. On the **Start** menu, point to **Programs**, point to **Hewlett-Packard**, point to **hp color LaserJet 2550 series**, and click **Add or Remove**.
3. On the Setup screen, click **Next**.
4. To remove specific software components, click **Modify the existing installation**. To remove all the printer software, click **Remove All**.

Note

Clicking **Remove All** requires you to have the software CD to complete the uninstallation.

5. Click the drop-down icon next to each feature that you want to remove. From the drop-down list, click **This feature will not be available**.
6. Click **Next**, and follow the directions on the screen. If the message "The following file is a shared file but is not used by any other programs. Would you like to delete it?" appears, click **Yes to All**. The system finishes removing files.
7. If prompted to restart the computer, click **OK**.

Uninstalling software for Windows by using Add or Remove Programs

An alternate method for uninstalling the printer software is to use the **Add or Remove Programs** method. This method does *not* require you to have the software CD.

1. Click **Start**, point to **Settings**, and click **Control Panel**.
2. Click **Add or Remove Programs**.
3. Scroll through the list of software programs and click **hp color LaserJet 2550 series printer**.
4. Click **Remove**.

Uninstalling software for Macintosh

To remove the printing software from your Macintosh, drag the HP LaserJet folder and PPDs to the Trash. If you are using Mac OS X, you must also drag the PDEs to the Trash.

For Mac OS 9.1: The PPDs are located in Macintosh HD\System Folder\Extensions
\Printer Descriptions.

For Mac OS X: The PPDs are located in Macintosh HD\Library\Printers\PPDs
\Contents\Resources\<lang>.lproj. The PDEs are located in Macintosh HD
\Library\Printers\PPD Plugins\HP*.

The phrase <lang> represents the language of the printer software that you selected.

Print-media specifications

This section contains information about specifications for the quality of print media, guidelines for print media usage, and guidelines for print media storage.

General guidelines

Some print media might meet all of the guidelines in this manual and still not produce satisfactory results. This problem might be the result of improper handling, unacceptable temperature and humidity levels, or other variables over which Hewlett-Packard has no control.

Before purchasing large quantities of print media, always test a sample and make sure the that the print media meets the requirements specified in this user guide and in the *HP LaserJet Printer Family Print Media Guide*. For ordering information, see [Accessories and ordering information](#).

CAUTION

Using print media that does not meet HP specifications can cause problems for the printer, requiring repair. This repair is not covered by the Hewlett-Packard warranty or service agreements.

This printer accepts a variety of media, such as cut-sheet paper (including up to 100 percent recycled-fiber-content paper), envelopes, labels, transparencies, glossy paper, HP LaserJet Tough paper, and custom-size paper. Properties such as weight, composition, grain, and moisture content are important factors affecting printer performance and output quality. Print media that does not meet the guidelines outlined in this manual can cause the following problems:

- Poor print quality
- Increased jams
- Premature wear on the printer, requiring repair

Paper and print media

Category	Specifications
Acid content	5.5 pH to 8.0 pH
Caliper	0.094 to 0.18 mm (3.0 to 7.0 mils)
Curl in ream	Flat within 5 mm (0.02 in.)
Cut-edge conditions	Cut with sharp blades with no visible fray
Fusing compatibility	Must not scorch, melt, offset, or release hazardous emissions when heated to 210° C (410° F) for 0.1 second
Grain	Long Grain
Moisture content	4 percent to 6 percent by weight
Smoothness	100 to 250 Sheffield

For complete print-media specifications for all HP LaserJet printers, see the *HP LaserJet Printer Family Print Media Guide*. To download the guide in PDF format, go to <http://www.hp.com/support/ljpaperguide>.

Printing and storage environment

Ideally, the printing and media-storage environment should be at or near room temperature, and not too dry or too humid. Remember that paper is hygroscopic; it absorbs and loses moisture rapidly.

Heat works with humidity to damage paper. Heat causes the moisture in paper to evaporate, while cold causes it to condense on the sheets. Heating systems and air conditioners remove most of the humidity from a room. As paper is opened and used, it loses moisture, causing streaks and smudging. Humid weather or water coolers can cause the humidity to increase in a room. As paper is opened and used it absorbs any excess moisture, causing light print and dropouts. Also, as paper loses and gains moisture it can distort. This issue can cause jams.

As a result, paper storage and handling are as important as the paper-making process itself. Paper storage environmental conditions directly affect the feed operation and print quality.

Care should be taken not to purchase more paper than can be easily used in a short time (about three months). Paper stored for long periods can experience heat and moisture extremes, which can cause damage. Planning is important to prevent damage to a large supply of paper.

Unopened paper in sealed reams can remain stable for several months before use. Opened packages of paper have more potential for environmental damage, especially if they are not wrapped with a moisture-proof barrier.

The media-storage environment should be properly maintained to ensure optimum printer performance. The required condition is 20° to 24° C (68° to 75° F), with a relative humidity of 45 percent to 55 percent. The following guidelines should be helpful when evaluating the paper's storage environment:

- Print media should be stored at or near room temperature.
- The air should not be too dry or too humid (to moderate the hygroscopic properties of paper).
- The best way to store an opened ream of paper is to rewrap it tightly in its moisture-proof wrapping. If the printer environment is subject to extremes, unwrap only the amount of paper to be used during the day's operation to prevent unwanted moisture changes.
- Avoid storing paper and print media near heating and air conditioning vents or near windows and doors that are frequently open.

Envelopes

Use only tray 1 to print on envelopes. Select the type of envelope that you are using from the **Print** dialog box or the printer driver.

In your program, set the margins for the envelope. The following table gives typical address margins for a commercial #10 or DL envelope.

Type of address	Top margin	Left margin
Return address	15 mm (0.6 inch)	15 mm (0.6 inch)
Delivery address	51 mm (2 inches)	89 mm (3.5 inches)

- For the best print quality, position margins no closer than 15 mm (0.6 inch) from the edges of the envelope.
- Avoid printing over the area where the envelope seams meet.

Envelope storage

Proper storage of envelopes helps contribute to print quality. Envelopes should be stored flat. If air is trapped in an envelope and creates an air bubble, then the envelope might wrinkle during printing.

For more information, see [Printing on envelopes](#).

Envelope construction

Envelope construction is critical. Envelope fold lines can vary considerably, not only between manufacturers, but also within a box from the same manufacturer. Successful printing on envelopes depends upon the quality of the envelopes. When selecting envelopes, consider the following components:

- **Weight:** The weight of the envelope paper should not exceed 90 g/m² (24 lb) or jamming might occur.
- **Construction:** Before printing, envelopes should lie flat with less than 6 mm (0.25 inch) curl, and should not contain air.
- **Condition:** Envelopes should not be wrinkled, nicked, or otherwise damaged.
- **Temperature:** Use envelopes that are compatible with the heat and pressure of the printer. This printer's fusing temperature is 210° C (410° F).
- **Size:** Use only envelopes that are within the following size ranges.

Tray	Minimum	Maximum
Tray 1	76 by 127 mm (3 by 5 inches)	216 by 356 mm (8.5 by 14 inches)

Envelopes with double side-seams

Double side-seam construction has vertical seams at both ends of the envelope rather than diagonal seams. This style might be more likely to wrinkle. Be sure the seam extends all the way to the corner of the envelope as illustrated below.

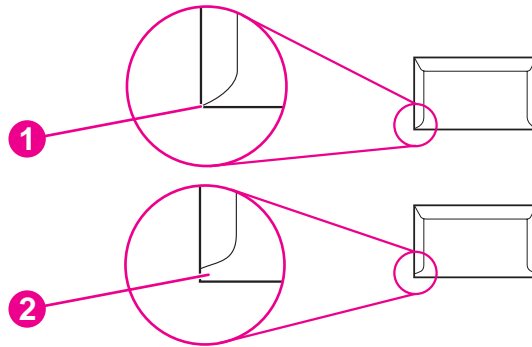

- 1 acceptable
- 2 unacceptable

Envelopes with adhesive strips or flaps

Envelopes with a peel-off adhesive strip or with more than one flap that folds over to seal must use adhesives that are compatible with the heat and pressure in the printer. The extra flaps and strips might cause wrinkling, creasing, or even jams and might damage the fuser.

Labels

Select the type of label that you are using from the **Print** dialog box or the printer driver.

CAUTION

To avoid damaging the printer, use only labels that are recommended for laser printers. To prevent serious jams, always use tray 1 to print on labels and always use the straight-through paper path. Never print on the same sheet of labels more than once or print on a partial sheet of labels.

When selecting labels, consider the quality of each component:

- **Adhesives:** The adhesive material should be stable at 210° C (410° F), which is the printer fusing temperature.
- **Arrangement:** Only use labels with no exposed backing between them. Labels can peel off sheets with spaces between the labels, causing serious jams.
- **Curl:** Before printing, labels must lie flat with no more than 13 mm (0.5 inch) of curl in any direction.
- **Condition:** Do not use labels that have wrinkles, bubbles, or other indications of separation.

For more information, see [Printing on labels](#).

Transparencies

Use only tray 1 to print on transparencies. Select **Transparencies** from the **Print** dialog box or the printer driver.

The printer supports printing on color transparencies. Use only transparencies that are recommended for use in laser printers.

Transparencies that are used in the printer must be able to withstand 210° C (410° F), which is the printer fusing temperature.

CAUTION

To avoid damage to the printer, use only transparencies that are recommended for use in laser printers. See [Accessories and ordering information](#).

For more information, see [Printing on transparencies](#).

Supported media weights and sizes

This section contains information about the sizes, weights, and capacities of paper and other print media that each tray supports.

Tray 1 specifications

Tray 1	Dimensions ¹	Weight	Capacity ²
Paper	Minimum: 76 by 127 mm (3 by 5 inches)	60 to 177 g/m ² (16 to 47 lb)	Up to 125 sheets of 75 g/m ² (20 lb) paper
	Maximum: 216 by 356 mm (8.5 by 14 inches)		
Glossy paper	Same as the preceding listed minimum and maximum sizes.	75 to 120 g/m ² (20 to 32 lb)	Maximum stack height: 12 mm (0.47 inches)
HP Cover paper ⁴		203 g/m ² (75 lb cover)	50 (typically)
Transparencies and opaque film		Thickness: 0.10 to 0.13 mm (3.9 to 5.1 mils)	50 (typically)
Labels ³		Thickness: up to 0.23 mm (up to 9 mils)	50 (typically)
Envelopes		Up to 90 g/m ² (16 to 24 lb)	Up to 10

¹The printer supports a wide range of standard and custom sizes of print media. Check the printer driver for supported sizes.

²Capacity can vary depending on media weight and thickness, and environmental conditions.

³Smoothness: 100 to 250 (Sheffield).

⁴Hewlett-Packard does not guarantee results when printing with other types of heavy paper.

Optional tray 2 specifications

Optional tray 2 (250-sheet tray)	Dimensions ¹	Weight	Capacity ²
Letter	216 by 279 mm (8.5 by 11 inches)	60 to 105 g/m ² (16 to 28 lb)	250 sheets of 75 g/m ² (20 lb) paper
A4	210 by 297 mm (8.3 by 11.7 inches)		
A5	148 by 210 mm (5.8 by 8.3 inches)		
B5 (ISO)	176 by 250 mm (6.9 by 9.9 inches)		
B5 (JIS)	182 by 257 mm (7.2 by 10 inches)		
Executive	191 by 267 mm (7.3 by 10.5 inches)		
Legal	216 by 356 mm (8.5 by 14 inches)		
8.5 by 13 inches	216 by 330 mm (8.5 by 13 inches)		

¹The printer supports a wide range of standard and custom sizes of print media. Check the printer driver for supported sizes.

²Capacity can vary depending on the media weight and thickness, and environmental conditions.

Optional tray 3 specifications

Optional tray 3 (500-sheet tray)	Dimensions ¹	Weight	Capacity ²
Letter	216 by 279 mm (8.5 by 11 inches)	60 to 105 g/m ² (16 to 28 lb)	500 sheets of 75-g/m ² (20-lb) paper
A4	210 by 297 mm (8.3 by 11.7 inches)		

¹The printer supports a wide range of standard and custom sizes of print media. Check the printer driver for supported sizes.

²Capacity can vary depending on the media weight and thickness, and environmental conditions.

2

Control panel

This section provides information about the control panel features.

Control panel features

The printer contains the following lights and buttons on the control panel:

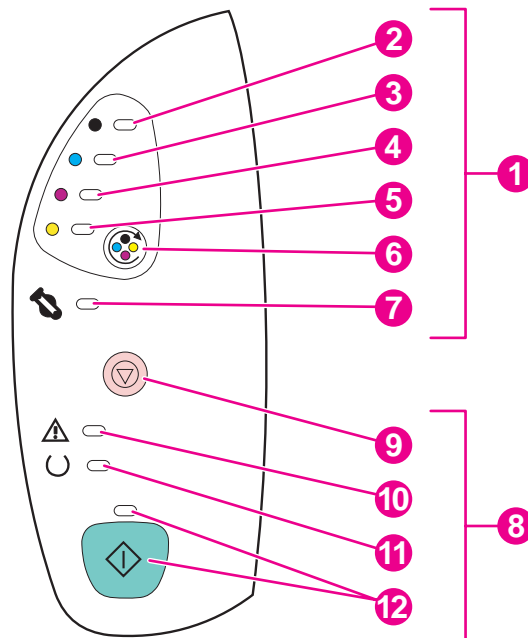

- 1 **Supplies status lights and buttons**
- 2 Black print-cartridge light
- 3 Cyan print-cartridge light
- 4 Magenta print-cartridge light
- 5 Yellow print-cartridge light
- 6 **ROTATE CAROUSEL** button
- 7 Imaging drum light
- 8 **Printer status lights and buttons**
- 9 **CANCEL JOB** button
- 10 Attention light (amber)
- 11 Ready light (green)
- 12 Go light and **Go** button (both green)

The lights and buttons are arranged into two main groups: Supplies Status (top) and Printer Status (bottom). To interpret and troubleshoot the control panel light messages, see [Resolving the control panel messages](#).

Understanding Supplies Status

The printer contains five lights and one button to indicate and control the status of the print cartridges and imaging drum. To interpret and troubleshoot control panel light messages, see [Resolving the control panel messages](#).

Black, Cyan, Magenta, and Yellow Supplies Status lights

These lights indicate when a print cartridge is low (the light is on), or empty or missing (the light blinks). The lights also indicate when a non-HP print cartridge is installed (the light blinks and the Attention light is on).

Rotate Carousel button

When the top cover is closed, pressing  (ROTATE CAROUSEL) rotates the print-cartridge carousel to bring the next print cartridge into the top position. The light for the print cartridge that is approaching the top position blinks quickly two or three times.





Imaging drum light

This light indicates when the imaging drum is low (light is on), or empty or missing (light blinks). The light also indicates when a non-HP imaging drum is installed (the light blinks and the Attention light is on).

Understanding Printer Status

The printer has two buttons and three lights to indicate and control the printer status. To interpret and troubleshoot the control panel light messages, see [Resolving the control panel messages](#).

Cancel Job button

- When the Ready light is blinking, pressing  (CANCEL JOB) cancels the current job.
- When the printer is not experiencing an error, pressing  (Go) and  (CANCEL JOB) simultaneously prints a Configuration page and a Supplies Status page. (If an HP Jetdirect print server is installed, an HP Jetdirect page also prints.)
- When a Supplies Status light is blinking and the Attention light is on (indicating that a non-HP supply has been installed), pressing  (CANCEL JOB) allows you to continue printing.

CAUTION

You might not receive any indication when a non-HP supply is empty. If you continue printing after the supply is empty, damage to the printer can occur. See [Hewlett-Packard limited warranty statement](#).

Attention light







Generally, the Attention light blinks when the printer is out of paper, when a jam has occurred, or when other problems that need attention occur.

The Attention light is on and one of the Supplies Status lights is blinking the first time a non-HP supply is installed.

Ready light

The Ready light is on when the printer is ready to print (experiencing no errors that prevent printing) and blinks when it is receiving data to be printed.

Go light and Go button

- When the Go light is on and the Attention light is blinking, pressing  (Go) continues the print job after you load print media for a manual feed, or clears some errors.
- When the Go light is blinking, the top cover has been opened and then closed or you have pressed  (ROTATE CAROUSEL). Pressing  (Go) returns the printer to the Ready state. If you do not press  (Go), the printer returns to the Ready state on its own.
- When the Go light is off, pressing  (Go) prints a Demo page. Pressing  (Go) and  (CANCEL JOB) simultaneously prints a Configuration page and a Supplies Status page. (If an HP Jetdirect print server is installed, an HP Jetdirect page also prints.)

3

Printing tasks

This section provides information about common printing tasks.

- [Loading trays](#)
- [Controlling print jobs](#)
- [Selecting an output location](#)
- [Printing on special media](#)
- [Printing on both sides \(duplexing manually\)](#)
- [Canceling a print job](#)

For information about managing the printer and its settings by using the HP Toolbox, see [Maintenance](#).

Loading trays

Load special print media, such as envelopes, labels, and transparencies, in tray 1 only. Load only paper in optional tray 2 or optional tray 3.

Note

Because tray 2 and tray 3 are not included for all models, they are referred to as optional tray 2 and optional tray 3 in this documentation.

Loading tray 1

Tray 1 (the multipurpose tray) holds up to 125 sheets of paper or other print media, or it holds up to 10 envelopes.

For information about loading special print media such as labels and transparencies, see [Printing on special media](#).

CAUTION

Avoid adding print media to tray 1 while the printer is printing, or jams can occur. Do not fan paper before loading it into trays, and avoid overloading trays.

To load tray 1

1. Open tray 1.

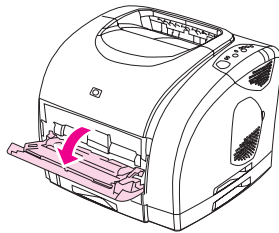

2. Slide out the tray extender. If the print media being loaded is longer than 23 cm (9 inches), also open the additional tray extender.

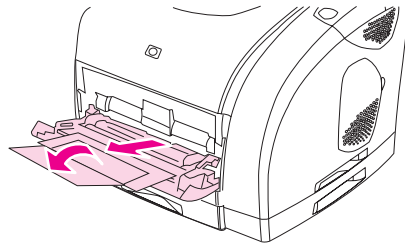

3. Slide the media-width guides slightly wider than the print media.

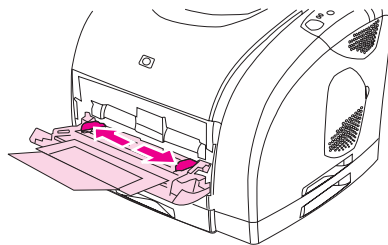

4. Place print media into the tray with the side to be printed up, and the top, short edge in first.

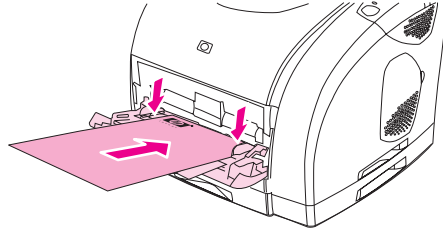

Note

If you are manually duplexing, see [Printing on both sides \(duplexing manually\)](#) for loading instructions.

5. Slide the media-width guides inward until they lightly touch the print media stack on both sides without bending it. Make sure that the print media fits under the tabs on the media-width guides.

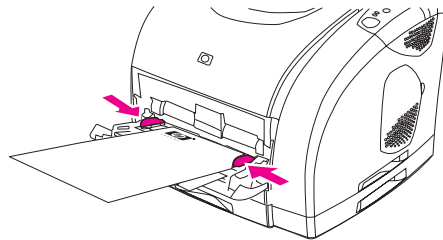

CAUTION

Wait for the printer to finish printing before closing tray 1. Closing the tray before the printer finishes can cause jams.

6. On the back of the printer, lower the rear output door if you are printing on special media, such as labels, envelopes, or heavy or light paper, to prevent curl.

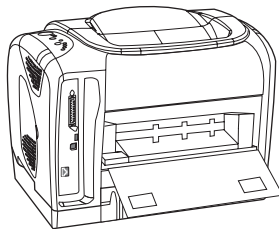

Loading optional tray 2

Paper includes average-weight letterhead and prepunched paper. For additional information about letterhead and prepunched paper, see [Printing on letterhead or preprinted forms](#).

CAUTION

Print on special print media such as labels and transparencies from tray 1 only. Printing on special print media from optional tray 2 or optional tray 3 can cause jams. Do not fan paper before loading it into trays, and avoid overloading trays.

To load optional tray 2

1. Pull optional tray 2 out of the printer and remove any paper.

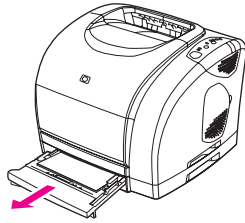

2. Move the media-width guides to match the size of paper that you are loading. Tray 2 accepts several standard paper sizes.

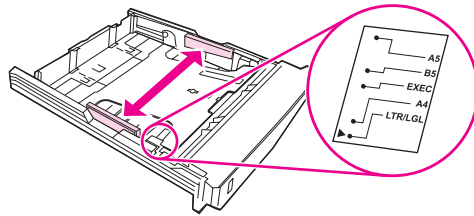

3. Extend the rear of the tray until the arrow on the markings points to the size that you are loading.

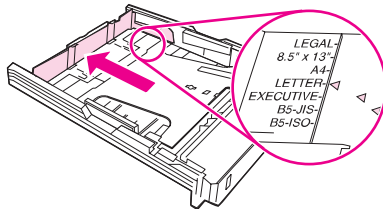

4. Load the paper. If this is special paper such as letterhead, load it with the side to be printed on facing down and the top edge toward the front of the tray.

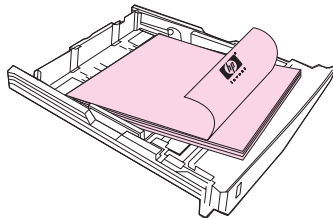

Note

If you are duplexing manually, see [Printing on both sides \(duplexing manually\)](#) for loading instructions.

5. Make sure that the stack of paper is flat in the tray at all four corners, and keep it below the height tabs on the media-length guide in the rear of the tray. Push down on the metal media-lift plate to lock it into place.

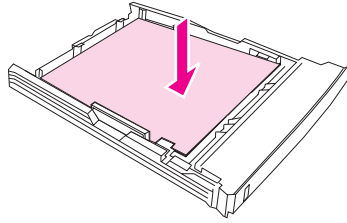

6. Slide the tray into the printer. If you set the rear of the tray to one of the longer sizes, the back of the tray will protrude from the back of the printer.

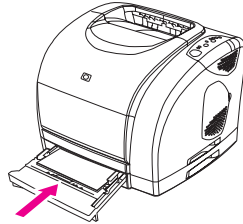

Loading optional tray 3

The optional tray 3 supports A4-size and letter-size paper. Optional tray 3 supports only paper, but paper includes average-weight letterhead and prepunched paper.

For additional information about letterhead and prepunched paper, see [Printing on letterhead or preprinted forms](#).

CAUTION

Print on special print media such as labels and transparencies from tray 1 only. Printing on special print media from optional tray 2 or optional tray 3 can cause jams. Do not fan paper before loading it into trays, and avoid overloading trays.

To load optional tray 3

1. Pull the tray out of the printer and remove any paper.

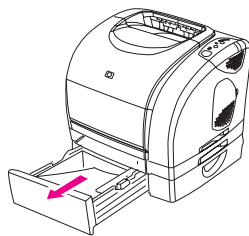

- For letter-size paper, pull the rear stop up. For A4-size paper, push the rear stop down.

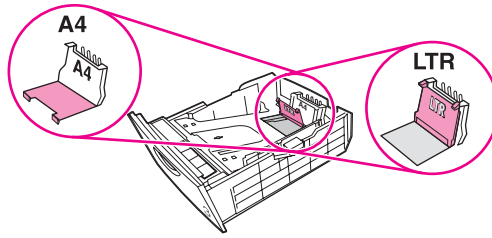

- For letter-size paper, move the media-width guides outward as far as possible. For A4-size paper, move the media-width guides inward as far as possible.

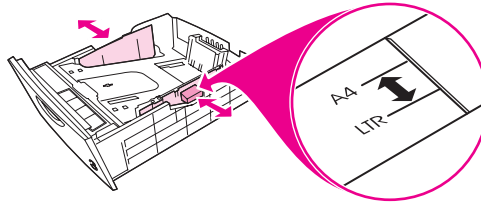

- Load the paper. If this is special paper such as letterhead, load it with the side to be printed on facing down and the top edge toward the front of the tray.

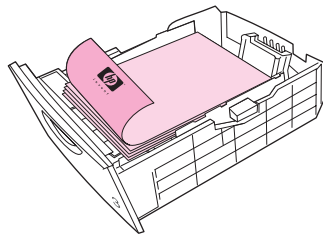

Note

If you are duplexing manually, see [Printing on letterhead or preprinted forms](#) for loading instructions.

- Make sure that the stack of paper is flat in the tray at all four corners, and keep it below the height tabs on the media-length guide in the rear of the tray.

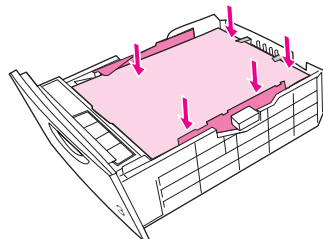

- Slide the tray into the printer.

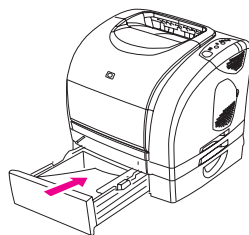

Controlling print jobs

This section provides basic printing instructions. When making changes to printing settings, follow the hierarchy of how changes are prioritized. (Note that the names of commands and dialog boxes might vary depending on your software program.)

- **"Page Setup" dialog box.** This dialog box opens when you click **Page Setup** or a similar command on the **File** menu in your software program. This dialog box is part of the program in which you are working. *Settings that are changed here override settings that are changed anywhere else.*
- **"Print" dialog box.** This dialog box opens when you click **Print**, **Print Setup**, or a similar command on the **File** menu in your software program. It is also part of the program, but it has a lower priority than the **Page Setup** dialog box. Settings that are changed in the **Print** dialog box *do not* override settings that are changed in the **Page Setup** dialog box. Settings that are changed here *do* override settings that are changed in the printer driver.
- **Printer driver.** The printer driver opens when you click **Properties** in the **Print** dialog box. Settings that are changed here *do not* override settings that are changed anywhere else. (For Macintosh, the printer driver settings are integrated into the **Print** dialog box.)

About printing by Source versus by Type or Size

Three settings affect how the printer driver tries to pull media when you send a print job. These settings, **Source**, **Type**, and **Size**, appear in your program **Page Setup** dialog box, the **Print** dialog box, or the printer driver. The printer automatically selects a tray if you do not change these settings. If you do want to change these settings, you can print by **Source**, by **Type**, by **Size**, or by **Type** and **Size**. (For Macintosh OS 9.x, types and sizes are both available from the **General** tab on the **Paper Source** pop-up menu. For Macintosh OS X, types and sizes are both available from the **Paper Feed** tab.)

- **Source.** Printing by *Source* means that you select a specific tray from which you want the printer to pull paper. The printer tries to print from this tray, no matter what type or size is loaded in it. However, if you select a tray that is configured from the HP Toolbox for a type or size and that does not match your print job, the printer does not print automatically. Instead, it waits for you to load the tray that you selected with the type or size of print media for your print job. If you load the tray, the printer begins printing. (If it does not begin, you might need to configure the tray to match the size or type of the print job.) Or, press  (**Go**) to have the printer try to print from another tray.
- **Type or Size.** Printing by **Type** or **Size** means that you want the printer to pull paper or print media from the first tray that is loaded with the type or size that you selected. *Always print by Type for special print media such as labels or transparencies.*
 - If you want to print by Type or Size and the trays have not been configured for a certain type or size from the HP Toolbox, load the paper or print media into tray 1 and then select the Type or Size from the **Page Setup** dialog box, the **Print** dialog box, or the printer driver.
 - If you often print on a certain type or size of media, the printer administrator (for a network printer) or you (for a directly connected printer) can use the HP Toolbox to configure a tray for that type or size. (See [HP Toolbox](#).) Then, when you select that Type or Size as you print a job, the printer pulls from the tray that is configured for that type or size.

To print from Windows

1. Make sure that print media is loaded in the printer.
2. On the **File** menu, click **Page Setup** or a similar command. Make sure that the settings are correct for this document.
3. From the **File** menu, click **Print**, **Print Setup**, or a similar command. The **Print** dialog box opens.
4. Select this printer and change settings as necessary. Do not change any settings, such as page size or orientation, that you set in the **Page Setup** dialog box.
5. If this print job is for a standard size and weight of paper, you probably do not need to change the **Source is** (tray), **Type is**, or **Size is** settings, and you can go to step 7. Otherwise, go to step 6.
6. If this print job is to be printed on a non-standard size or weight of paper, select how the printer pulls paper.
 - To print by Source (tray), select the tray in the **Print** dialog box, if possible.
 - To print by Source (tray) when this setting is not available in the **Print** dialog box, click **Properties**, and on the **Paper** tab, select the tray in the **Source is** field.
 - To print by Type or Size, click **Properties** and, on the **Paper** tab, select the type or size in the **Type is** or **Size is** field. (For some paper, such as letterhead, you will set both the Type and Size.) *Always print by Type for special print media such as labels or transparencies.*
7. If you have not yet done so, click **Properties**. The printer driver opens.
8. On the various tabs, set any settings that you want that did not appear in the **Page Setup** or **Print** dialog box. For more information about printer-driver settings, see [Features in the printer driver](#).
9. By default, the printer prints to the top output bin, which is the best location for most print jobs, including transparencies. For labels, heavy paper, or other special print media, lower the rear output door on the printer.
10. Select the **Print** command to print the job.

To print from the Macintosh OS

1. Make sure that paper is loaded in the printer.
2. On the **File** menu, click **Page Setup**.
3. Make sure that this printer is selected on the **Format for** pop-up menu.
4. Select the size of paper onto which you are printing.
5. Select the **Orientation** and **Scale**, if necessary, and click **OK**.
6. On the **File** menu, click **Print**.
7. Use one of the following methods to select the Source (tray) from which you want to print or select the Type of media onto which you want to print. *Always print by Type for special print media such as labels or transparencies.*
 - **Mac OS 9.1:** On the **General** pop-up menu, select the tray or type of media from the **Paper Source** pop-up menu.
 - **Mac OS X:** On the **Paper Feed** pop-up menu, select the tray or type of media.

8. Set any other settings that you want, such as watermarks. (For more information, see [Gaining access to printer driver settings.](#))
9. By default, the printer prints to the top output bin, which is the best location for most print jobs, including transparencies. For labels, heavy paper, or other jobs that require a straight-through path, lower the rear output door on the printer.
10. Select the **Print** command to print the job.

Maximizing print speed for letter-size paper

The printer can print at 20 ppm in black on letter-size paper. When printing letter-size pages from tray 2, this happens automatically.

For tray 1, the printer is set at the factory to print 19 ppm in black on letter-size paper. To achieve a print speed of 20 ppm from tray 1, set the tray 1 size to **letter**. To set the tray 1 size, open the HP Toolbox, click the **Settings** tab, click **Configure Device**, and click **Paper Handling**. Set the tray 1 size to **letter**.

When tray 1 is configured for **letter**, and a print job specifies another media size such as envelopes, the Attention light blinks until you load the correct print media into tray 1.

Gaining access to printer driver settings

This section lists the common printing features that are controlled through the printer driver. (The printer driver is the software component you use to send print jobs to the printer.) You can change settings temporarily for the print jobs that you print while the program is still open. You can also make permanent changes to the default settings, and those new settings will be in effect now and in the future.

Operating System	Temporarily change settings for jobs that are printed now	Permanently change default settings ¹	Change configuration settings (For example, to add an optional tray or to enable or disable a driver feature such as "Allow manual duplexing")
Windows 98, Me, and NT 4.0	On the File menu, click Print , select this printer, and then click Properties . (The actual steps can vary; this is the most common method.)	Click Start , point to Settings , and then click Printers . Right-click the printer icon, and then click Properties (Windows 98 and Me) or Document Defaults (NT 4.0).	Click Start , point to Settings , and then click Printers . Right-click the printer icon, and then click Properties . Click the Configure tab.
Windows 2000 and XP	On the File menu, click Print , select this printer, and then click Properties or Preferences . (The actual steps can vary; this is the most common method.)	Click Start , point to Settings , and then click Printers or Printers and Faxes . Right-click the printer icon, and then click Printing Preferences .	Click Start , point to Settings , and then click Printers or Printers and Faxes . Right-click the printer icon, and then click Properties . Click the Device Settings tab.
Mac OS 9.1	On the File menu, click Print . Change settings as necessary on the various pop-up menus.	On the File menu, click Print . As you change settings on a pop-up menu, click Save Settings .	Click the desktop printer icon. From the Printing menu, click Change Setup .

Operating System	Temporarily change settings for jobs that are printed now	Permanently change default settings ¹	Change configuration settings (For example, to add an optional tray or to enable or disable a driver feature such as "Allow manual duplexing")
Mac OS X v. 10.1	On the File menu, click Print . Change settings as necessary on the various pop-up menus.	On the File menu, click Print . To change settings as necessary, use the various pop-up menus, and then on the main pop-up menu, click Save Custom Settings . These settings are saved as the Custom option. To use the new settings, you must select the Custom option every time that you open a program and print.	Delete the printer and reinstall it. The driver automatically reconfigures with the new options.
Mac OS X v. 10.2	On the File menu, click Print . Change settings as necessary on the various pop-up menus.	On the File menu, click Print . To change settings as necessary, use the various pop-up menus, and then on the Presets pop-up menu, click Save as and type a name for the preset. These settings are saved in the Presets menu. To use the new settings, you must select the saved preset option every time that you open a program and print	Open Print Center. (Click the hard drive, click Applications , click Utilities , and then double-click Print Center .) Click the print queue. On the Printers menu, click Show Info . Click the Installable Options menu.

¹Access to default printer settings might be restricted and therefore unavailable.

Using the PCL printer-driver Help (Windows only)

When you are in the printer driver, you can use its Help, which is separate from the Help in a program. You can activate Help for the printer driver in two ways.

- Click the **Help** button anywhere it appears in the printer driver. The Help windows give detailed information about the specific printer driver in use.
- When you see a  (bubble icon), click it to view information about the field, option, or button that the bubble adjoins.

Features in the printer driver

Some printer drivers and some operating systems do not support all these printer features.

- Selecting a Source
- Selecting a Type or Size
- Setting a custom paper size
- Printing in grayscale
- Changing the color settings
- Creating and using watermarks

- Printing multiple pages on one sheet of paper (N-up printing)
- Creating and using Quick Sets
- Reducing or enlarging
- Printing on different paper for the first page
- Changing the print quality
- Restoring the default printer-driver settings

For manual duplexing, see [Printing on both sides \(duplexing manually\)](#).

Selecting a Source

You can print by Source (tray) or by Type or Size. To print by Source, follow these steps. For more information, see [Controlling print jobs](#). For Macintosh operating systems, types and sizes are grouped together under the **Paper Source** pop-up menu.

- Windows: In the **Print** dialog box in your software program, select the Source (tray), if possible. Otherwise, select a tray from the **Source is** field from the **Paper** tab in your printer driver.
- Mac OS 9.x: In the **Print** dialog box, select a tray on the **Paper Source** pop-up menu on the **General** pop-up menu.
- Mac OS X: From the **Print** dialog box, select the tray or type of media on the **Paper Feed** pop-up menu.

Selecting a Type or Size

You can print by Source (tray) or by Type or Size. If you are printing on special print media, such as heavy paper, it is important to print by Type to achieve good results. To print by Type or Size, follow these steps. For more information, see [Controlling print jobs](#). For Macintosh operating systems, types and sizes are all grouped together under the **Paper Source** pop-up menu.

- Windows: In the printer driver, select a type in the **Type is** field of the **Paper** tab. Or, select a size from the **Size is** field. For some paper, such as letterhead, you select both a type and size.
- Mac OS 9.x: In the **Print** dialog box, select a type on the **Paper Source** pop-up menu on the **General** pop-up menu.
- Mac OS X: In the **Print** dialog box, select the tray or type of media on the **Paper Feed** pop-up menu.

Setting a custom paper size

Use the Custom Paper feature to set up the printer to print to sizes other than standard ones.

- Windows: Try to set this setting from *one* of these locations, in this order: the **Page Setup** dialog box in the program, the **Print** dialog box in the program, or the **Paper** tab in the printer driver.
- Mac OS 9.x: Gain access to Custom Paper features in the **Page Setup** dialog box. On the **Page Attributes** pop-up menu, select **Custom Page Size**.
- Mac OS X: To set a custom paper size, click **File**, and then click **Page Setup**. Click the **Page Attributes** menu, and select **Custom Paper Size**. (Mac OS X v. 10.1 does not support custom paper-size settings.)

Printing in grayscale

If you have a document that you created in color, it will automatically print in color. Or, you can set the printer to print a color document in grayscale (black and white) only.

- Windows: Select the **Print In Grayscale** option on the **Color** tab of the printer driver.
- Mac OS: In the **Print** dialog box, select the **Color Options** tab, and then select the **Print Color as Gray** checkbox.

Changing the color settings

When you are printing in color, the printer driver automatically sets the optimal color settings for you. However, you can manually make adjustments to how the printer prints in color for text, graphics, and photographs. See [Using color](#) for more information.

- Windows: On the **Color** tab of the printer driver, click **Options**.
- Mac OS 9.x: In the **Print** dialog box, select either the **Color Options** tab or the **Color Matching** tab.
- Mac OS X: In the **Print** dialog box, click the **Color Options** tab, and then the **Show Advanced Options** button.

Creating and using watermarks

Use the Watermark options to specify that text be placed "underneath" (in the background of) an existing document. For example, you might want to have large gray letters reading "draft" or "confidential" placed diagonally across the first page or all pages of a document. You can change color, position, and wording of the watermark.

Note

If you are using Windows 2000 or XP, you must have Administrator privileges to create watermarks. You do not need Administrator privileges to add existing watermarks to documents.

- Windows: Gain access to the **Watermark** options on the **Effects** tab in your printer driver.
- Mac OS: Gain access to the Watermark options on the watermark/overlay pull-down menu in the **Print** dialog box. (Note that OS X might not support Watermarks.)

Printing multiple pages on one sheet of paper (N-up printing)

N-up printing is the ability to print multiple pages on one sheet of paper. The pages will appear decreased in size. You can specify up to nine pages per sheet, and they will be arranged on the sheet as shown in the following figures if you use the default arrangement. You can also choose whether a border appears around each page or not.

- Windows: Gain access to **Pages per Sheet** on the **Finishing** tab in the printer driver.
- Mac OS: Gain access to Pages per sheet by selecting the **Layout** pop-up menu in the **Print** dialog box.

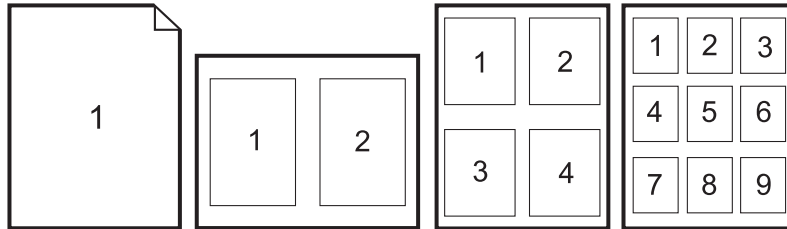

Creating and using Quick Sets

Use Quick Sets to save the current print-driver settings such as the page orientation, N-up printing, or the paper source for later use. You can save up to a total of 30 sets of settings. For convenience, Quick Sets can be selected and saved from most printer-driver tabs.

Note

If you are using Windows 2000, you must have Administrator privileges to save Quick Sets.

- Windows: Create Quick Sets from most printer-driver tabs. Later, you can gain access to Quick Sets on the **Finishing** tab in the printer driver.
- Mac OS: This feature is not supported.

Reducing or enlarging

Use the **Fit to Page** option to scale your document to a percentage of its normal size. You can also choose to scale your document to fit on any size of paper that the printer supports.

- Windows: Gain access to **Fit to Page** settings on the **Effects** tab in the printer driver.
- Mac OS: Gain access to Reduce and Enlarge (**Scale**) settings in the **Page Setup** dialog box.

Printing on different paper for the first page

Printing on different paper for the first page is useful if, for example, you are printing a letter that uses letterhead on the first page and plain sheets for the subsequent pages. The size for all pages of the print job must be the same in the printer driver.

- Windows: Try to set this setting from *one* of these locations, in this order: the **Page Setup** dialog box in the program, the **Print** dialog box in the program, or the **Paper** tab in the printer driver.
- Mac OS 9.x: On the **General** pop-up menu in the **Print** dialog box, select the **First Page from** option. Then, select the source for the first page.
- Mac OS X: On the **Paper Feed** pop-up menu in the **Print** dialog box, select the **First Page from** option. Then, select the source for the first page.

Changing the print quality

The printer driver automatically chooses settings for your document to optimize the quality of the output. However, you can change these advanced settings, such as raster compression or scale patterns (WYSIWIG).

- Windows: Gain access to the Print Quality settings by clicking **Details** on the **Finishing** tab.
- Mac OS: This feature is not supported.

Restoring the default printer-driver settings

You can return all settings in the printer driver to their default values. This feature might be useful if you are experiencing quality issues, or if the print media is not being selected from the correct tray.

- Windows: Select **Defaults** in the **Quick Sets** dialog box on the **Finishing** tab of the printer driver.
- Mac OS 9.x: Drag the desktop printer icon to the Trash, and then set up the printer.
- Mac OS X: The Standard option contains the default settings and is automatically selected each time you open a program.

Selecting an output location

The printer comes with the top output bin and a rear output door for printing to a straight-through paper path. Print jobs emerge from the top output bin when the rear output door is closed. Print jobs emerge from the back of the printer when the rear output door is open.

- Use the top output bin when printing most jobs, including jobs on average-weight paper and letterhead, and transparencies. The top output bin can hold up to 125 sheets. Prevent more than 125 sheets from accumulating in the top output bin, or jams can occur.
- Use the rear output door (straight-through paper path) if problems occur when printing to the top output bin. Remove each sheet as it exits the printer.

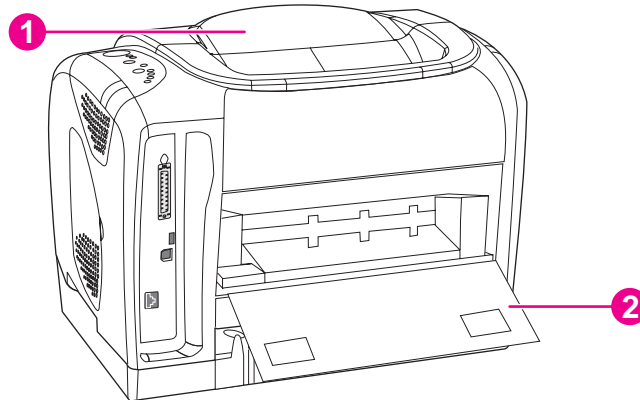

- 1 top output bin
- 2 rear output door

Printing on special media

Printing speeds might be automatically reduced when printing on any special print media.

Printing on envelopes

- Load envelopes into tray 1 only.
- Do not load more than 10 envelopes into tray 1.
- The weight of the envelope paper should not exceed 90 g/m² (24 lb).
- Make sure that envelopes are not damaged and are not stuck together.
- Never use envelopes that have clasps, snaps, windows, coated linings, self-stick adhesives, or other synthetic materials.
- If you are using a non-standard size of envelope, select the appropriate envelope as the Type.

CAUTION

Failure to follow the guidelines above can result in jams.

For more information, see [Print-media specifications](#).

To print on envelopes

1. Open tray 1 and slide out the extender fully. If tray 1 is already open, remove any paper or other print media from it.

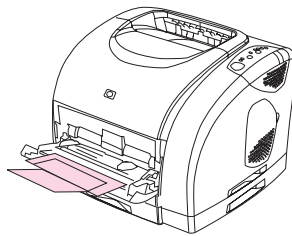

2. On the back of the printer, lower the rear output door to prevent the envelopes from curling.

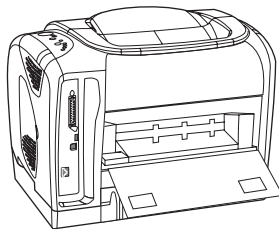

- Slide the side-width guides in tray 1 outward until they are slightly wider than the envelopes.

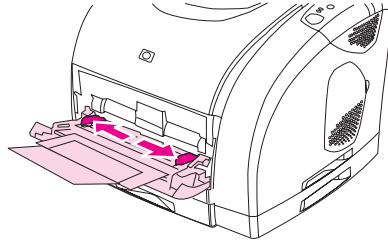

- Place the stack of envelopes into the tray with the side to be printed on facing up and with the short edge leading into the printer. The stamp end must enter the printer first.

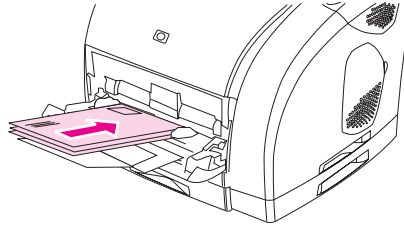

Note

If the envelope has a flap on a short edge, this edge must enter the printer first.

- Slide the side-width guides inward until they lightly touch the stack without bending it. The stack should be centered between the guides and must be under the tabs on the guides.

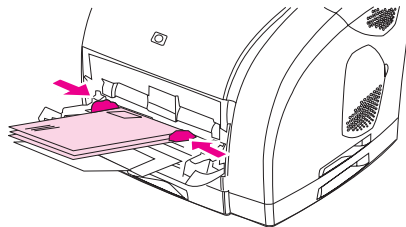

- Select the envelope you are using as the Size (Windows) or the Paper Source (Macintosh) in the **Print** dialog box or the printer driver.

Printing on labels

Follow these guidelines for using labels. See [Print-media specifications](#) for more details.

CAUTION

To avoid damaging the printer, use only labels that are recommended for laser printers. To prevent serious jams, always use tray 1 to print on labels and always use the straight-through paper path. Never print on the same sheet of labels more than once or print on a partial sheet of labels.

- Avoid labels that are separating from the backing sheet or are wrinkled or damaged in any way.
- Place labels only in tray 1 with the side to be printed on facing up and the top, short edge in first.

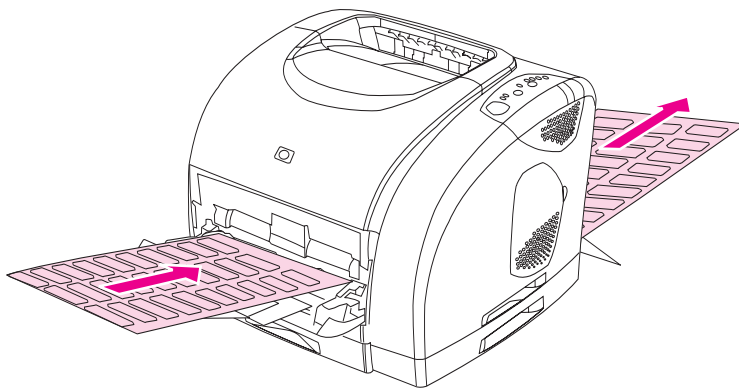

- Select **Labels** as the Type (Windows) or the Paper Source (Macintosh) from the **Print** dialog box or the printer driver.
- Remove label sheets as they print from the straight-through paper path to prevent them from sticking together.
- If a sheet of labels jams in the printer, see [Clearing jams](#).

Printing on transparencies

The printer supports printing on color transparencies. See [Transparencies](#) for more details.

CAUTION

To avoid damaging the printer, use only transparencies that are recommended for laser printers. To prevent serious jams, always use tray 1 to print transparencies.

- Load transparencies into tray 1 only.

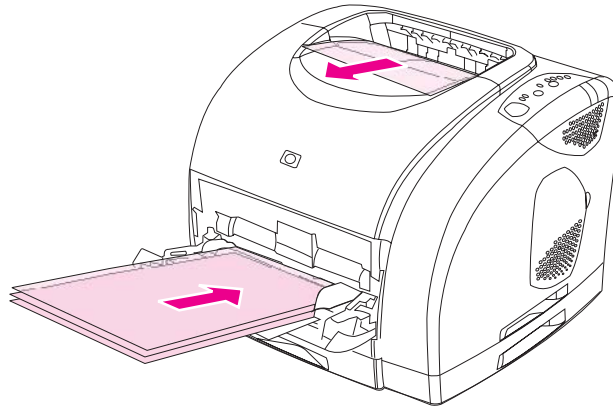

- Select **Transparencies** as the Type (Windows) or the Paper Source (Macintosh) in the **Print** dialog box or the printer driver.
- Use the top output bin to reduce curling. (This rule is for transparencies only. For other special print media, use the straight-through paper path to reduce curling.)
- To prevent transparencies from sticking together, remove each one from the top output bin as it prints.
- Place transparencies on a flat surface after removing them from the printer.

Printing on glossy paper

This printer supports printing on glossy paper. Follow these guidelines when printing on glossy paper. See [Print-media specifications](#) for more information.

- Load glossy paper into Tray 1 only.

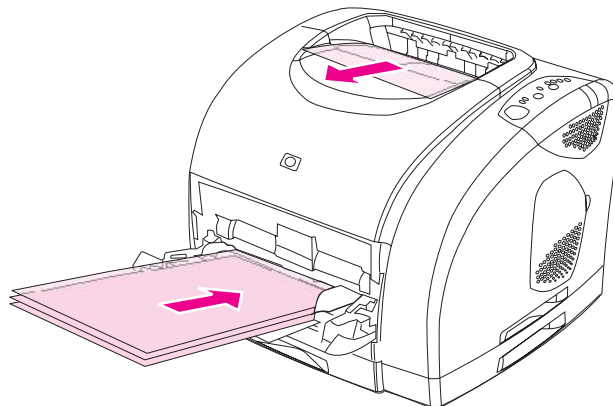

- Select **Glossy** or **Heavy Glossy** as the Type (Windows) or the Paper Source (Macintosh) in the **Print** dialog box or the printer driver. Select **Glossy** for media weights up to 120 g/m² (32 lb bond). Select **Heavy Glossy** for media weights up to 163 g/m² (43 lb bond).

Printing on HP LaserJet Tough paper

When printing on HP LaserJet Tough paper, follow these guidelines:

- Handle HP LaserJet Tough paper by the edges. Oil from your fingers that is deposited on HP LaserJet Tough paper can cause print-quality problems.
- Use only HP LaserJet Tough paper with this printer. HP products are designed to work together for optimum printing results.
- In either the software program or the printer driver, select **Tough Paper** as the media type, or print from a tray that is configured for HP LaserJet Tough paper.

CAUTION

Transparent print media that is not designed for LaserJet printing will melt in the printer, and will damage the printer.

Printing on custom-sized print media or cardstock

Postcards, 3-by-5-inch (index) cards, and other custom-sized print media can be printed on from tray 1. The minimum size is 76 by 127 mm (3 by 5 inches) and the maximum size is 216 by 356 mm (8.5 by 14 inches).

- Always insert the short edge first into tray 1. To print in landscape mode, make this selection through your program. Inserting the media long-edge-first might cause a jam.
- In your program, set margins at least 6.4 mm (0.25 inch) away from the edges of the print media.
- Select the custom media that you are using as the **Type** in the printer driver and set the correct **Size**.
- Lower the rear output door to use the straight-through paper path and reduce curl.

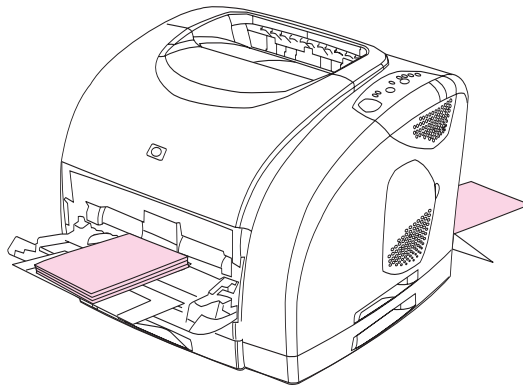

See [Print-media specifications](#) for more information.

Printing on letterhead or preprinted forms

This section shows how to orient letterhead or preprinted forms when you are printing only on one side. For duplex (two-sided printing) orientation, see [Printing on both sides \(duplexing manually\)](#).

- Orient paper as shown in the following figures.

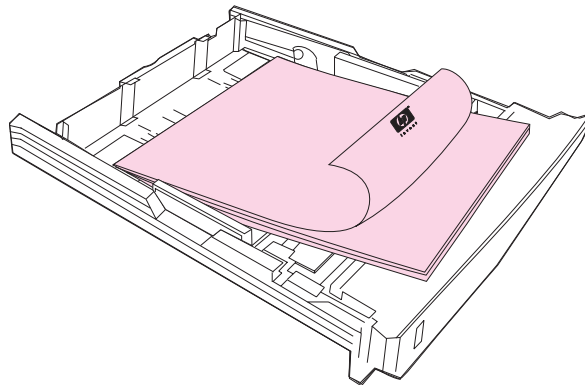
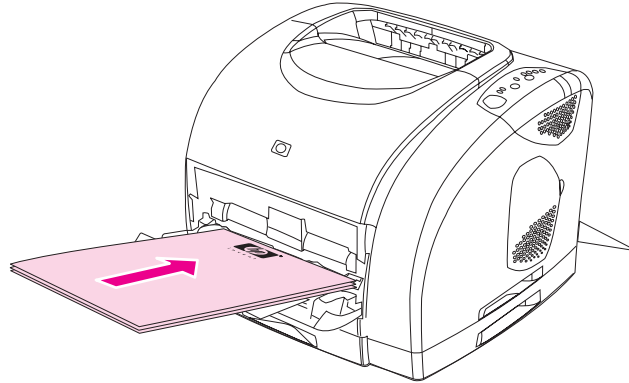

- If the print media is heavy, lower the rear output door to reduce curl.
- Avoid using raised or embossed letterhead.
- Avoid using letterhead that is printed with low-temperature inks, such as those used in some types of thermography.
- The printer uses heat and pressure to fuse toner to the print media. Make sure that any colored paper or preprinted forms use inks that are compatible with this fusing temperature (210° C or 410° F for 0.1 second).

Printing on both sides (duplexing manually)

To print on both sides of the paper, you have to return to the printer and reinsert the paper manually after the first side has printed.

CAUTION

Do not print on both sides of labels or transparencies. Damage to the printer and jams might result.

Note

The PS printer driver does not support manual duplexing. For Mac OS 9.x you must perform a custom driver installation and select the plug-in for manual duplexing. Mac OS X does not support manual duplexing.

To duplex manually

1. Insert enough paper into one of the trays to accommodate the print job. If you are loading special paper such as letterhead, load it in one of these ways.
 - For tray 1, load the letterhead paper with the front side down, and the bottom edge leading into the printer first.
 - For optional tray 2 and optional tray 3, load the letterhead paper with the front side up, and the top edge toward the back of the tray.

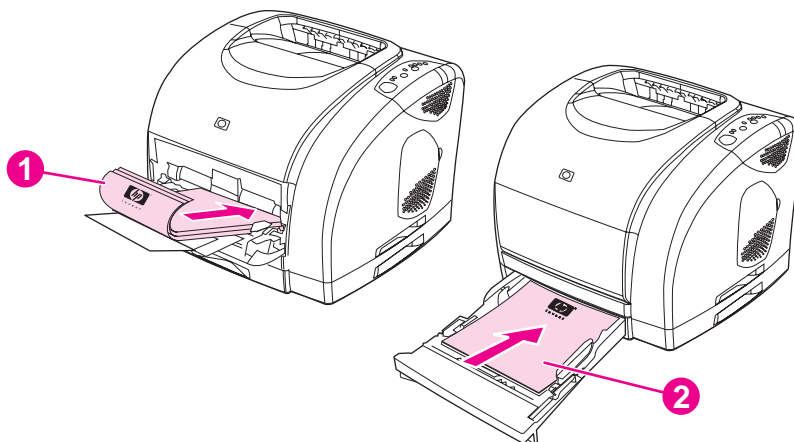

- 1 tray 1
- 2 optional tray 2 or optional tray 3

2. In the printer driver, select the **Print on Both Sides** option and send the job to print.

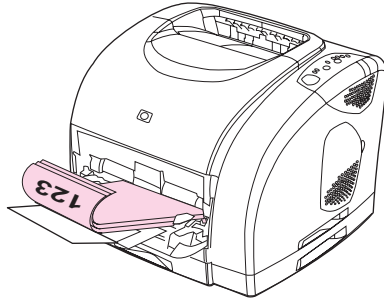

3. After the job finishes printing, remove any blank paper from tray 1. Insert the printed stack, with the blank side up, and the top edge leading into the printer. Print the second side from tray 1.



4. Press  (Go) to continue printing.

Canceling a print job

A print job can be canceled from a program, from a print queue, or from the  (CANCEL JOB) button on the printer.

- If the printer has not started printing, first try to cancel the job within the program that sent the print job.
- If the print job is waiting in a print queue or print spooler such as the **Printers** folder in Windows (**Printers or faxes** in Windows 2000 or Windows XP) or **Print Monitor** or **Print Center Queue** in Mac OS, try to delete the job from there next.
- If the print job is already printing, press  (CANCEL JOB) on the printer. The printer finishes printing any pages that are already moving through the printer and deletes the remainder of the print job.
- Pressing  (CANCEL JOB) cancels only the current job in the printer. If more than one print job is in printer memory, you must press  (CANCEL JOB) once for each job after the job starts printing.

If the Printer Status lights continue to cycle after a job has been canceled, the computer is still sending the job to the printer. Either delete the job from the print queue or wait until the computer finishes sending data.

4

Managing the printer

This printer comes with several software tools that help you monitor, troubleshoot problems with, and maintain the printer. Information about using these tools is in the following sections:

- [Special pages](#)
- [HP Toolbox](#)

Special pages

Special pages reside within the memory of the printer. These pages help you to diagnose and solve problems with the printer.



Note

If the printer language was not correctly set during installation, you can set the language manually so that the pages print in one of the supported languages. Change the language by using the HP Toolbox ([HP Toolbox](#)) or HP Web Jetadmin.

Demo page

To print the Demo page, press  (Go) when the printer is Ready (Ready light on) and is not printing. You can also view this page from the HP Toolbox.

Configuration page

The Configuration page lists current settings and properties of the printer. You can print a Configuration page from the printer or the HP Toolbox. To print the Configuration page from the printer, briefly press  (Go) and  (CANCEL JOB) simultaneously. (The Supplies Status page is also printed. If you have an HP Jetdirect print server installed, the HP Jetdirect page that lists the HP Jetdirect information is also printed.)

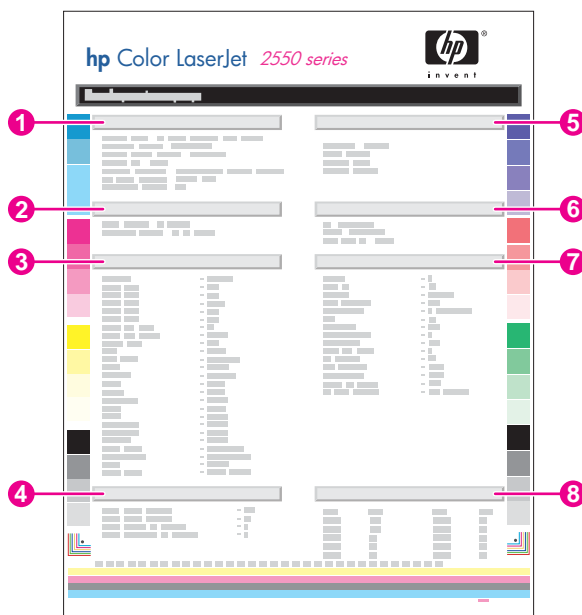



1. **Product Information.** This section contains basic information about the printer, such as the product name and the serial number.
2. **Memory.** This section lists memory-related information, such as the total memory that is installed.
3. **Paper Settings.** This section lists information about the media type for each tray and about the type settings for all the media that the printer supports.

4. **Page Counts.** This section lists the total number of pages printed, the number of color pages printed, and information about paper jams.
5. **Product Settings.** This section lists information that is gathered during software installation, including the language and the company name.
6. **Installed Personalities and Options.** This section contains information about optional items that might be installed, such as a DIMM or an HP Jetdirect print server.
7. **Print Settings.** This section contains information about printer settings that are configured in the printer driver or in HP Toolbox.
8. **Status Log.** This section contains information about printer errors.

Supplies Status page

The Supplies Status page lists the remaining life of HP print cartridges and HP imaging drums. It also lists the estimated pages remaining, number of pages printed, and other supplies information. You can print a Supplies Status page from the printer or the HP

Toolbox. To print from the printer, press  (Go) and  (CANCEL JOB) simultaneously. (The Configuration page is also printed. If you have an HP Jetdirect print server installed, the HP Jetdirect page that lists the HP Jetdirect information is also printed.)

Note

Supplies information is also available through the HP Toolbox.

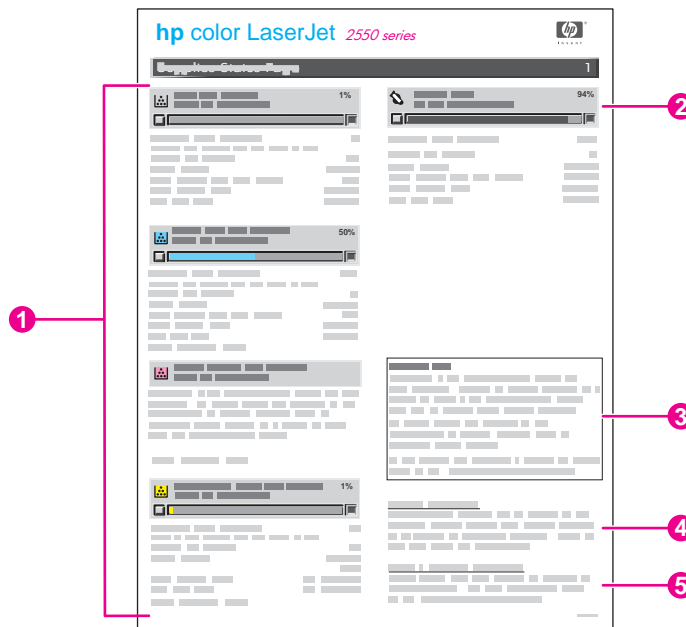

1. **Print-cartridge area.** This area contains a section for each of the print cartridges and provides information about HP print cartridges. This information includes the part number for each print cartridge, whether each print cartridge is low, and the life remaining for each print cartridge expressed as a percentage, as a graphic, and as the estimated number of pages remaining. This information might not be provided for non-HP supplies. In some cases, if a non-HP supply is installed, you see an alert message instead.
2. **Imaging-drum area.** This area contains the same information for the imaging drum that the print-cartridge area provides for the print cartridges.

3. **Warranty Note.** This section contains information about how the printer warranty is affected when you use non-HP supplies. It also requests that you call the HP fraud hotline if a supply that is being detected as a non-HP supply was sold to you as a genuine HP supply. (See [HP fraud hotline](#).)
4. **Ordering Information.** This section contains basic information about how to order new HP supplies.
5. **Recycling Information.** This section contains a link to the website that you can visit for information about recycling.

HP Toolbox

The HP Toolbox is a Web application that you can use for the following tasks:

- Check the printer status.
- Configure the printer settings.
- View troubleshooting information.
- View online documentation.

You can view the HP Toolbox when the printer is directly connected to your computer or when it is connected to the network. You must perform a complete software installation to use the HP Toolbox.

Note

You do not have to have Internet access to open and use the HP Toolbox. However, if you click a link in the **Other Links** area, you must have Internet access to go to the site that is associated with the link. See [Other links](#) for more information.

Supported operating systems

The HP Toolbox is supported for the following operating systems:

- Windows 98, 2000, Me, and XP
- Mac OS X, v. 10.1 or later

Supported browsers

To use the HP Toolbox, you must have one of the following browsers:

Windows

- Microsoft Internet Explorer 5.5 or later
- Netscape Navigator 6.2 or later
- Opera Software ASA Opera 7 or later

Macintosh (OS X only)

- Microsoft Internet Explorer 5.1 or later
- Netscape Navigator 6.23 or later
- Safari 1.0

All pages can be printed from the browser.

To view the HP Toolbox

1. Open the HP Toolbox in one of these ways:
 - On the Windows desktop, double-click the HP Toolbox icon.
 - On the Windows **Start** menu, point to **Programs**, and click the **HP Toolbox**.
 - For Macintosh OS X, on the hard drive, click **Applications**, and then click the **Utilities** folder. Double-click the **HP Toolbox icon**.

Note

After you open the URL, you can bookmark it so that you can return to it quickly in the future.

2. The HP Toolbox opens in a Web browser. The HP Toolbox software contains the following sections:
 - [Status tab](#)
 - [Troubleshooting tab](#)
 - [Alerts tab](#)
 - [Documentation tab](#)
 - [Device Settings window](#)
 - [HP Toolbox links](#)
 - [Other links](#)

Status tab

The **Status** tab has links to the following main pages:

- **Device Status.** View printer status information. This page indicates printer conditions such as a jam or an empty tray. After you correct a problem with the printer, click the **Refresh** button to update the device status.
- **Supplies Status.** View detailed supplies status such as the percent of toner remaining in the print cartridge and the number of pages that have been printed with the current print cartridge. This page also has links to order supplies and to find recycling information.
- **Print Info.** Print the configuration page and various other information pages that are available for the printer, such as the supplies status page and the demo page.

Troubleshooting tab

The **Troubleshooting** tab has links to the following main pages:

- **Printer Lights.** Click the control panel lights on this simulator to find help for a specific control panel light pattern. For several conditions, animated video clips are available that demonstrate the recommended action to solve the problem.
- **Print Quality Tools.** Print a page that assists in solving print-quality problems, view information about print-quality problems, print the cleaning page and clean the printer, and calibrate the printer to maintain color print quality.
- **Maintenance.** Print the cleaning page and clean the printer, view information about printer supplies, and view animated demos of how to replace the print cartridges and the imaging drum.
- **Paper Jams.** View information on locating and clearing jams, and view an animated demo of how to clear jams.

- **Supported Media.** View information about media that the printer supports, and view information about solving problems related to print media.
- **Demo Page.** Print the Demo page for this printer.

Alerts tab

Use the **Alerts** tab to configure the printer to automatically notify you of printer alerts. The **Alerts** tab has links to the following main pages:

- Set up status alerts
- Set up e-mail alerts
- Administrative settings

Set up status alerts page

On the Set up status alerts page, you can choose to turn alerts on or off, specify when the printer should send an alert, and select from two different types of alerts:

- a pop-up message
- a task bar icon

Click **Apply** to activate the settings.

Set up e-mail alerts page

On the Set up e-mail alerts page, you can set the e-mail addresses that you want to have alerts sent to, and specify what kind of alerts should go to which e-mail addresses. You can have two e-mail destinations for the following alerts:

- supplies
- service
- paper path
- advisory

You must set up a simple mail transfer protocol (SMTP) server to send e-mail alerts.

Administrative settings page

On the Administrative settings page, you can set the frequency of how often the HP Toolbox checks for printer alerts. Three settings are available:

- **Less Often.** The HP Toolbox checks for alerts once per minute (every 60 seconds).
- **Normal.** The HP Toolbox checks for alerts twice per minute (every 30 seconds).
- **More Often.** The HP Toolbox checks for alerts twenty times per minute (every 3 seconds).

If you want to reduce network input/output (I/O) traffic, reduce the frequency at which the printer checks for alerts.

Documentation tab

The **Documentation** tab contains links to these information sources:

- **User Guide.** Contains the information about the printer usage, warranty, specifications, and support that you are currently reading. The user guide is available in both HTML and PDF format.
- **Readme.** Contains important information about the printer that is not available in the user guide. The Late-Breaking Readme contains last-minute information about the printer (in English only).

Device Settings window

When you click the **Device Settings** button, a new window opens. The Device Settings window has the following sections:

- **Information** tab
- **Settings** tab
- **Network** link

Information tab

The Information tab provides quick links to the following information:

- **Device Status.** View information about the printer's current status.
- **Supplies Status.** View information about the supplies installed in the printer. A link is provided to the HP Web site for ordering supplies.
- **Event Log.** View a history of printer errors. The most recent error is at the top of the list.
- **Save/Restore Settings.** Save the current settings for the printer to a file on your computer. Use this file to load the same settings onto another printer or to restore these settings to this printer at a later time.
- **Device Configuration.** View a detailed description of the printer's current configuration including the amount of memory installed and whether optional trays are installed.

Settings tab

The **Settings** tab has links to several pages where you can view and change the printer's configuration.

Note

Software settings can override settings that are made in the HP Toolbox.

- **Device Information.** View basic information about the printer.
- **Paper Handling.** View and change the settings for the printer's trays.
- **Printing.** View and change the default printer job settings.
- **PCL.** View and change the PCL font information.
- **PostScript.** View and change settings for PS errors and timeout.
- **Print Quality.** View and change the print-quality settings.
- **Print Modes.** View and change the print modes for various media types.
- **System Setup.** View and change system information.

- **I/O.** View and change the I/O timeout setting.
- **Service.** Gain access to various procedures required to service the printer.

Network window

The network administrator can use the **Network** window to control the network-related settings for the printer when it is connected to an IP-based network. This button will not appear if the printer is directly connected to a computer, or if the printer is connected to a network through anything other than an HP Jetdirect print server.

HP Toolbox links

The HP Toolbox links at the left of the screen provide links to the following options:

- **Select a device.** Select from all of the HP Toolbox-enabled devices.
- **View current alerts.** View the current alerts for all printers that have been set up. (You must be printing to view the current alerts.)
- **Text only page.** View HP Toolbox as a site map that links to text-only pages.

Other links

This section contains links that connect you to the Internet. You must have Internet access in order to use any of these links. If you use a dial-up connection and did not connect when you first opened the HP Toolbox, you must connect before you can visit these Web sites. Connecting might require that you close the HP Toolbox and reopen it.

- **Product Registration.** Connects to the HP product registration Web site.
- **Product Support.** Connects to the support site for the HP color LaserJet 2550 series printer. Then, you can search for help with a specific problem.

5

Color

This chapter describes how the printer provides great color printing. This chapter also describes ways to produce the best possible color prints. The following topics are covered:

- [Using color](#)
- [Managing color options](#)
- [Matching colors](#)

Using color

This printer offers great color as soon as you set it up. It provides a combination of automatic color features to generate excellent color results for the general user, plus sophisticated tools for the experienced color user.

The printer provides carefully designed and tested color tables to provide smooth, accurate color rendition of all printable colors.

HP ImageREt 2400

Image REt 2400 provides 2400 dots-per-inch (dpi) color laser-class quality through a multi-level printing process. This process precisely controls color by combining up to four colors within a single dot and by varying the amount of toner in a given area. ImageREt 2400 has been improved for this printer. The improvements offer trapping technologies, greater control over dot placement, and more precise control of toner quality in a dot. These new technologies, coupled with HP's multilevel printing process, result in a 600-by-600 dpi printer that provides 2400-dpi color laser-class quality with millions of smooth colors.

In contrast, the single-level printing process found in the default mode of other color laser printers does not allow the colors to be mixed within a single dot. This process, called dithering, significantly hinders the ability to create a wide range of colors without reduced sharpness or visible dot structure.

Media selection

For the best color and image quality, it is important to select the appropriate media type from the software printer menu or from the printer driver. See [Print-media specifications](#) for more information.

Color options

Color options enable optimal color output automatically for diverse types of documents.

Color options use object tagging, which allows optimal color and halftone settings to be used for different objects (text, graphics, and photos) on a page. The printer driver determines which objects are used on a page and uses halftone and color settings that provide the best print quality for each object. Object tagging, combined with optimized default settings, produces great color from the printer without having to establish any special settings.

In the Windows environment, the **Automatic** and **Manual** color options are on the **Color** tab in the printer driver.

Standard red-green-blue (sRGB)

Standard red-green-blue (sRGB) is a worldwide color standard that was originally developed by HP and Microsoft as a common color language for monitors, input devices (scanners and digital cameras), and output devices (printers and plotters). It is the default color space that is used for HP products, Microsoft operating systems, the World Wide Web, and most office software that is sold today. The sRGB standard is representative of the typical Windows computer monitor today and is the convergence standard for high-definition television.

Note

Factors such as the type of monitor you use and the room's lighting can affect the appearance of colors on your screen. For more information, see [Matching colors](#).

The latest versions of Adobe® PhotoShop®, CorelDRAW™, Microsoft Office, and many other applications use sRGB to communicate color. Most importantly, as the default color space in Microsoft operating systems, sRGB has gained broad adoption as a way to exchange color information between software programs and devices by using a common definition that assures that typical users will experience greatly improved color matching. The sRGB standard improves your ability to match colors between the printer, the computer monitor, and other input devices (scanners and digital cameras) automatically, without the need to become a color expert.

Managing color options

Setting color options to **Automatic** typically produces the best possible print quality for color documents. However, in some situations, you might want to print a color document in grayscale (black and shades of gray) or to change one of the printer's color options.

- Using Windows, print in grayscale or change the color options by using settings on the **Color** tab in the printer driver.
- Using a Macintosh computer, print in grayscale or change the color options by using the **Color Matching** pop-up menu in the **Print** dialog box.

Print in Grayscale

Selecting the **Print in Grayscale** option from the printer driver prints a document in black and shades of gray. This option is useful for printing color documents that will be photocopied or faxed.

When **Print in Grayscale** is selected, the printer goes into monochrome mode. Printing in this mode reduces wear on the color print cartridges.

Automatic versus Manual color adjustment

The **Automatic** color adjustment option optimizes the neutral gray color treatment, halftones, and edge enhancements that are used for each element in a document. For more information, see your printer-driver online Help.

Note

Automatic is the default setting and is recommended for printing all color documents.

Use the **Manual** color adjustment option to adjust the neutral gray color treatment, halftones, and edge enhancements for text, graphics, and photographs. To gain access to the Manual color options, on the **Color** tab, click **Manual**, and then click **Settings**.

Manual color options

Use the Manual color adjustment to adjust the **Color** (or **Color Map**) and **Halftoning** options.

Note

Some software programs convert text or graphics to raster images. In these cases, the **Photographs** setting also controls the text and graphics.

Halftone options

Halftoning is the method by which the printer mixes the four primary colors (cyan, magenta, yellow, and black) in varying proportions to create millions of colors. Halftone options affect the resolution and clarity of your color output. You can independently adjust halftone settings for text, graphics, and photos. The two halftone options are **Smooth** and **Detail**.

- The **Smooth** option provides better results for large, solid-filled print areas. It also enhances photos by smoothing out fine color gradations. Choose this option when uniform and smooth area fills are the most important attributes.
- The **Detail** option is useful for text and graphics that require sharp distinctions among lines or colors, or images that contain a pattern or a high level of detail. Choose this option when sharp edges and details are the most important attributes.

Neutral Grays

The **Neutral Grays** setting determines the method for creating gray colors that are used in text, graphics, and photographs.

- **Black Only** generates neutral colors (grays and black) by using only black toner. This option guarantees that neutral colors do not have a color cast.
- **4-Color** generates neutral colors by combining all four colors of toner. This option produces smoother gradients and transitions to non-neutral colors. It also produces the darkest possible black.

Edge Control

The **Edge Control** setting determines how edges are rendered. Edge Control consists of two components: Adaptive Halftoning and Trapping. Adaptive Halftoning increases the edge sharpness. Trapping reduces the effect of color-plane misregistration by slightly overlapping the edges of adjacent objects. The following levels of edge control are available:

- **Maximum** provides the most trapping. Adaptive Halftoning is set to On.
- **Normal** provides the default trapping settings. Adaptive Halftoning is set to On.
- **Light** provides minimal trapping. Adaptive Halftoning is set to On.
- **Off** sets Trapping and Adaptive Halftoning to Off.

RGB Color

The **RGB Color** option determines how colors are rendered.

- **Default** interprets RGB color as sRGB, which is the accepted standard for many software companies and organizations, such as Microsoft and the World Wide Web Consortium. (See <http://www.w3.org>.)
- **Vivid** instructs the printer to increase the color saturation in the midtones. Less colorful objects are rendered more colorfully. This value is recommended for printing business graphics.
- **Device** sets the printer to print RGB data in raw device mode. To render photographs properly when this option is selected, you must manage color in the program in which you are working or in the operating system.

Matching colors

The process of matching printer output color to your computer screen is quite complex because printers and computer monitors use different methods of producing color. Monitors *display* colors by light pixels using an RGB (red, green, blue) color process, but printers *print* colors using a CMYK (cyan, magenta, yellow, and black) process.

The following factors can influence your ability to match printed colors to those on your screen:

- print media
- printer colorants (inks or toners, for example)
- printing process (inkjet, press, or laser technology, for example)
- overhead lighting
- programs
- printer drivers
- computer operating system
- monitors
- video cards and drivers
- operating environment, (very humid or very dry)
- personal differences in perception of color

Keep these factors in mind when colors on your screen do not perfectly match your printed colors. For most users, the best method for matching colors on your screen to your printer is to print sRGB colors. The printer uses sRGB and automatically optimizes color output.

For more information about solving issues that are related to color output, see [Solving issues with color documents](#).

6

Maintenance

This chapter contains information about these maintenance topics:

- [Managing supplies](#)
- [Cleaning the printer](#)
- [Calibrating the printer](#)

Managing supplies

For warranty information about these supplies, see [Print Cartridge Limited Warranty Statement](#).

Supplies life

The life of the imaging drum depends on the number of black-only or color pages that print jobs require. An HP color LaserJet 2550 series printer imaging drum could last an average of 20,000 pages when printing black-only pages and 5,000 pages when printing color pages. Actual life lies somewhere between these two numbers, depending on the number of black-only pages you print versus color. The average life is between 6,000 and 8,000 pages.

Imaging-drum life is also affected each time the printer calibrates because calibrating causes the imaging drum to rotate. Imaging-drum life is measured in terms of number of rotations rather than number of pages printed.

The type and length of print jobs also affects drum life. A series of short print jobs uses more drum life than an equivalent number of pages printed in a single large job. To extend drum life, print multiple copies of a print job at one time rather than sending the same job to the printer multiple times.

The life of a print cartridge depends on the amount of toner that print jobs require. When printing text at 5 percent coverage, a cyan, magenta, or yellow print cartridge for the HP color LaserJet 2550L printer lasts an average of 2,000 pages, and a black print cartridge lasts an average of 5,000 pages. When printing text at 5 percent coverage, a cyan, magenta, or yellow print cartridge for the HP color LaserJet 2550Ln or 2550n printer lasts an average of 4,000 pages, and a black print cartridge lasts an average of 5,000 pages. A typical business letter has 5 percent coverage.

Note

The imaging drum and print cartridges for this printer are not compatible with older printer models such as the HP color LaserJet 1500 series printer or the HP color LaserJet 2500 series printer.

For longer supplies life, you can order replacement cyan, magenta, or yellow print cartridges for the HP color LaserJet 2550L printer that last an average of 4,000 pages at 5 percent coverage. See [Accessories and ordering information](#) for ordering information.

Checking and ordering supplies

You can check the supplies state by using the printer control panel, printing a Supplies Status page, viewing the HP Toolbox, or viewing HP Web Jetadmin. Hewlett-Packard recommends that you place an order for a replacement print cartridge when you first receive the Low message for a print cartridge. For typical use, the Low message indicates that approximately two weeks of life remains. When you use a new, authentic HP print cartridge or imaging drum, you can obtain the following types of supplies information:



- amount of cartridge or drum life remaining
- estimated number of pages remaining
- number of pages printed
- other supplies information

Note

If the printer is connected to the network, you can set the HP Toolbox to notify you by e-mail when a print cartridge is low or the imaging drum is near the end of its useful life. If the printer is directly connected to a computer, you can set HP Toolbox to notify you when supplies are low.

To check status and order using the control panel

Do one of the following:

- Check the supplies status lights on the printer control panel. These lights indicate when a print cartridge or the imaging drum is low or empty. The lights also indicate when a non-HP print cartridge is first installed. See [Supplies Status lights](#) to interpret the light patterns.
- Press  (Go) and  (CANCEL JOB) simultaneously. A Supplies Status page (and the Configuration page, and possibly the HP Jetdirect page) prints. Check the supplies levels on the Supplies Status page. See [Supplies Status page](#) for more information.

If the supplies levels are low, you can order supplies through your local HP dealer, by telephone, or online. See [Accessories and ordering information](#) for part numbers. See <http://www.hp.com/go/ljsupplies> to order online.

To check and order using HP Toolbox

You can configure HP Toolbox to notify you when the supplies are low. You can choose to receive alerts by e-mail or as a pop-up message or taskbar icon. To order supplies by using the HP Toolbox, in the **Other Links** area, click **Order supplies**. You must have Internet access to connect to the website.

For more information, see [HP Toolbox](#).

To check and order using HP Web Jetadmin

In HP Web Jetadmin, select the printer device. The device status page shows supplies information. To order, use the HP Toolbox. Or, see [Accessories and ordering information](#).

Storing supplies

Follow these guidelines for storing print cartridges and the imaging drum:

- Do not remove the print cartridge or imaging drum from its package until you are ready to use it.

CAUTION

To prevent damage, do not expose the print cartridge or imaging drum to light for more than a few minutes.

- See [Environmental specifications](#) for operating and storage temperature ranges.
- Store the supply in a horizontal position.
- Store the supply in a dark, dry location away from heat and magnetic sources.

Replacing and recycling supplies

To install a new HP print cartridge or imaging drum, follow the instructions that are included in the box that contains the new supply, or see the getting started guide.

To recycle supplies, place the used supply in the box in which the new supply arrived. Use the enclosed return label to send the used supply to HP for recycling. For complete information, see the recycling guide that is included with each new HP supply item. See [HP LaserJet printing supplies](#) for more information about HP's recycling program.

HP policy on non-HP supplies

Hewlett-Packard Company cannot recommend the use of non-HP supplies, either new or remanufactured. Because they are not HP products, HP cannot influence their design or control their quality. Service or repairs required as a result of using a non-HP supply will *not* be covered under the printer warranty.

When you insert a supply into the printer, the printer will inform you if the supply is not a genuine HP supply. If you insert a genuine HP supply that has reached the low state from another HP printer, the printer identifies the supply as non-HP. Simply return the supply to the original printer to reactivate HP features and functionality.

Resetting the printer for non-HP supplies

When you install a non-HP print cartridge or imaging drum, the light next to the print cartridge or imaging drum you replaced blinks and the Attention light is on. In order to print with this supply, you must press  (CANCEL JOB) the first time you install this non-HP supply. The status lights will not indicate when this type of supply is low or empty.

CAUTION

The printer will not stop printing when this type of supply is empty. Printer damage could occur if the printer prints with an empty print cartridge or imaging drum. See [Hewlett-Packard limited warranty statement](#) and [Print Cartridge Limited Warranty Statement](#).

HP fraud hotline

Call the HP fraud hotline if the supplies status lights or HP Toolbox indicates that the print cartridge or imaging drum is not an HP print cartridge and you think that it is genuine. HP will help determine if the product is genuine and take steps to resolve the problem.

Your print cartridge or imaging drum might not be a genuine HP one if you notice the following issues:

- You are experiencing a large number of problems with the print cartridge or imaging drum.
- The print cartridge or imaging drum does not look like it usually does (for example, the pull tab or the box is different).

In the United States, call toll-free: (1) (877) 219-3183.

Outside the United States, you can call collect. Dial the operator and ask to place a collect call to this telephone number: (1) (770) 263-4745. If you do not speak English, a representative at the HP fraud hotline who speaks your language will assist you. Or, if someone who speaks your language is not available, a language line interpreter will connect approximately one minute after the beginning of the call. The language line interpreter is a service that will translate between you and the representative for the HP fraud hotline.

Cleaning the printer

During the printing process, paper, toner and dust particles can accumulate inside the printer. Over time, this buildup can cause print-quality problems such as toner specks or smearing. This printer has a cleaning mode that can correct and prevent these types of problems.

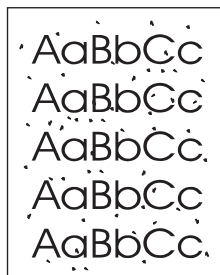

To clean the engine

Note

The following procedure must be performed from the HP Toolbox. To clean the engine when the computer is running an operating system that does not support HP Toolbox, see the late-breaking Readme on the root of the CD-ROM, or visit <http://www.hp.com/support/clj2550>.

1. Make sure that the printer is turned on and in the Ready state.
2. Open the HP Toolbox.
3. On the **Troubleshooting** tab, click **Maintenance**, click **Cleaning Page** and then click **Print**. A page with a pattern prints from the printer.
4. At the printer, remove any print media that might be in tray 1.
5. Remove the page that printed and load it face-down into tray 1.

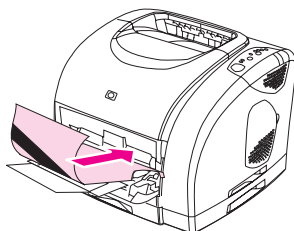

6. At the computer, press **Clean**.

Calibrating the printer

The printer automatically calibrates at various times. You can adjust the calibration settings by using the HP Toolbox.

Environmental differences, aging print cartridges, aging toner, and an aging imaging drum might cause fluctuations in image density. The printer accounts for this with image stabilization control. The printer automatically calibrates at various times to maintain the highest level of print quality. You can also request a calibration by using the HP Toolbox.

The printer does not interrupt a print job to calibrate. It waits until the job is complete before calibrating or cleaning. While the printer is calibrating, it pauses printing for the time that is required to complete the calibration.

To calibrate the printer at the printer

Press  (Go) and  (ROTATE CAROUSEL) simultaneously to start a calibration.

To calibrate the printer from the HP Toolbox

Note

This procedure applies to Windows operating systems only. Macintosh users should calibrate the printer manually using the procedure above.

1. Open the HP Toolbox in one of these ways:
 - On the desktop, double-click the **HP Toolbox** icon.
 - On the **Start** menu, point to **Programs**, point to **HP color LaserJet 2550**, and click **HP Toolbox**.
2. On the **Troubleshooting** tab, click **Diagnostic Tools** (on the left side of the screen).
3. Click **Color Calibration**.

7

Problem solving



This troubleshooting information is organized to help you resolve printing problems. Choose the general topic or type of problem from the following list.

- [Resolving problems that did not generate messages](#)
- [Checking the network](#)
- [Solving general printing problems](#)
- [Solving PostScript \(PS\) errors](#)
- [Solving common Macintosh problems](#)
- [Resolving problems that generated messages](#)
- [Resolving the control panel messages](#)
- [Clearing jams](#)
- [Solving print-media problems](#)
- [Solving print-quality problems](#)

Resolving problems that did not generate messages

If the printer is not responding properly, complete the steps in the following checklist, in order. If the printer does not pass a step, follow the corresponding troubleshooting suggestions. If a step resolves the problem, you can stop without performing the rest of the steps on the checklist.

Troubleshooting checklist

1. Make sure the printer Ready light is on. If no lights are on, complete these steps:
 - a. Check the power cable connections.
 - b. Check that the power switch is on.
 - c. Check the power source by plugging the printer directly into the wall or into a different outlet.
 - d. If none of these measures restores power, contact HP Customer Care. (See [HP customer care](#) or the support flyer that came in the printer box.)
2. Check the cabling.
 - a. Check the cable connection between the printer and the computer or network port. Make sure that the connection is secure.
 - b. Make sure that the cable itself is not faulty by using a different cable, if possible.
 - c. Check the network connection. See [Checking the network](#).
3. Ensure that the print media you are using meets specifications. See [Print-media specifications](#).
4. Press  (Go) and  (CANCEL JOB) simultaneously to print a Configuration page and a Supplies Status page. If the printer is network-enabled, an HP Jetdirect page also prints.
 - a. If the pages do not print, check that at least one tray contains print media.
 - b. If the page jams in the printer, go to [Clearing jams](#).
5. If the Configuration and Supplies Status pages print, check the following items.
 - a. If the pages print correctly, then the printer hardware is working. The problem is with the computer you are using, with the printer driver, or with the program.
 - b. If the pages do not print correctly, calibrate the printer. See [Calibrating the printer](#). Print the pages again. If the pages still do not print correctly, the problem is with the printer hardware. Contact HP Customer Care. (See [HP customer care](#) or the support flyer that came in the printer box.)
6. At the computer, check the print queue or print spooler (Print Monitor or Print Center Queue for Mac OSs) to see if the printer is paused or set to print offline.
7. Verify that you have installed the HP color LaserJet 2550 series printer driver. Check the program to make sure that you are using an HP color LaserJet 2550 series printer driver.
8. Print a page from the HP Toolbox.
 - a. If it prints, then the problem is with the printer driver. For Windows, try using the other printer driver. Or, for Windows or Macintosh, uninstall the printer driver (see [Uninstalling the printing software](#)) and reinstall it (see the getting started guide).
 - b. If the page does not print, then the problem is with the computer or the program.

9. Print a short document from a different program that has worked in the past. If this solution works, then the problem is with the program you are using. If this solution does not work (the document does not print) complete these steps:
 - a. Try printing the job from another computer that has the printer software installed.
 - b. If you connected the printer to the network, connect the printer directly to a computer with a parallel or USB cable. Redirect the printer to the proper port, or reinstall the software, choosing the new connection type you are using.
10. If the problem is still not resolved, see [Solving general printing problems](#).

Checking the network

It is recommended that you use the HP color LaserJet 2550 CD-ROM to install and set up the printer on a network. Follow these steps to see if the problem is caused by the network.

- When you printed the Configuration page, an HP Jetdirect configuration page should have printed if the printer is network-enabled. (If these pages do not print in your language, see [Special pages](#).) Verify that all network settings are properly configured. For more information about the HP Jetdirect page, see the *HP Jetdirect Administrator's Guide*, which can be installed from the **View Documentation** or **User Documentation** sections on the HP color LaserJet 2550 CD-ROM.
- See the *HP Jetdirect Administrator's Guide*, which can be installed from the **View Documentation** or **User Documentation** sections on the HP color LaserJet 2550 CD-ROM.
- Contact your network administrator for assistance.

Solving general printing problems

In addition to the problems listed in this section, see [Solving common Macintosh problems](#) if you are using a Macintosh computer, and see [Solving PostScript \(PS\) errors](#) if you are using the PS driver.

The print job is extremely slow.

Cause	Solution
The job might be very complex (if it contains graphics, for example).	<ul style="list-style-type: none">• Wait for the job to print.• Reduce the complexity of the page or try adjusting the print-quality settings. If this problem occurs frequently, add memory to the printer.
The maximum printer speed is 19 ppm in black for A4-size paper, 20 ppm in black for letter-size paper, and 4 ppm in color (for A4 or letter). This speed cannot be exceeded even when more memory is added.	Wait for the print job to finish.
Printing speeds might be automatically reduced when printing on special-sized media.	Wait for the print job to finish.
In the printer driver, the Type or Size is set for card stock or other special media.	<ul style="list-style-type: none">• If you are printing on special media, the Type or Size should be set to match the media. The printer prints more slowly for some media types to provide better quality. Wait for the job to print.• If you are not printing on special media, set Type or Size in the printer driver to plain paper.• In the default settings for this printer, click the Paper tab and ensure that Type is set to plain paper. You can override this setting from the printer driver when you print on special media.
An issue might exist with the driver.	If you were printing by using the PCL driver, print by using the PS driver, or vice versa.
The printer might be hot.	If the printer has been printing for a long time and is hot, it automatically slows its printing speed to prevent print-quality defects. To restore the printer to full speed, stop printing and wait for the printer to cool.

The printer pulls paper or print media from the wrong tray.

Cause	Solution
The Source (tray) selection might be incorrect.	<ul style="list-style-type: none"> For Windows, ensure that the Source is selected from the Print dialog box (which is part of the program) if possible or from the printer driver. If you select the Source in the printer driver and then select a different Source in the Print dialog box, the Source setting in the printer driver changes to match the Source setting in the Print dialog box. For Macintosh, set the Source in the Print dialog box. Remove any print media from other trays to make the printer select from the tray that you want.
The Type or Size setting does not match the size of paper or print media that is loaded in the tray.	Using the HP Toolbox, change the Type or Size setting for the tray to match the size of print media that is loaded.
Media is loaded in tray 1.	Remove any media from tray 1. The printer pulls from tray 1 if you did not specify a tray that had a compatible size or type loaded and tray 1 is unconfigured.

Printer does not pull paper from optional tray 2 or optional tray 3.

Cause	Solution
The rear paper length guide (optional tray 2) or the rear paper stop (optional tray 3) is set incorrectly.	To set the rear guides properly, see Loading optional tray 2 or Loading optional tray 3 .
The tray is not recognized in the printer driver.	<p>Set the printer driver to recognize the tray as follows:</p> <p>Windows: Click Start, point to Settings, and click Printers. Right-click the printer name, and click Properties. Click the Configure tab or the Device Settings tab. Select the correct tray as an installed option.</p> <p>Mac OS X: (OS 9.x setup might vary): Open Print Center and click the HP color LaserJet print queue. Click Printers, and then click Show Info. Click Installable Options, and select correct tray. Click Apply Changes.</p>
If the printer does not pull paper from either tray, the paper might be the problem.	<ul style="list-style-type: none"> Try a different type or brand of paper. Ensure that you are using a high-quality paper made for laser printers. Coated and photo papers are not supported. See Print-media specifications. To order, see Accessories and ordering information.
The printer does not recognize the tray.	Turn the printer off then on.
The separation pad and the pickup rollers might be worn.	Replace the separation pad and pickup rollers. Contact HP Customer Care to order parts. See HP customer care or see the support flyer that shipped in the printer box.

The printer does not recognize a DIMM that is installed.

Cause	Solution
The DIMM is not recognized in the printer driver.	Set the printer driver to recognize the DIMM. See Enabling memory .
The DIMM is not properly installed.	Remove the DIMM, and reinstall it.

The printer does not respond when the Print command is selected in the software.

Cause	Solution
The printer experienced an error.	Check the control panel lights on the printer to determine if an error exists.
If no control panel lights are on, the printer is not receiving power.	<ul style="list-style-type: none"> ● Check the power cable connection between the printer and the power source. ● Check that the power switch is on. ● Check that the power source (outlet or surge protector) is receiving power. ● If none of the above measures works, contact HP Customer Care. See HP customer care or see the support flyer that shipped in the printer box.
The printer might be in Manual Feed mode (Attention light blinking and Go light on).	Add paper to tray 1 if it is empty. If paper is already in the tray, press  (Go).
The wrong printer was selected in the software.	In the Print or Printer Setup dialog box, make sure that the HP color LaserJet 2550 printer is selected.
A jam might exist.	Clear any jams. See Clearing jams .
The printer is on a network and is not receiving a signal.	<ul style="list-style-type: none"> ● Disconnect the printer from the network and attach it directly to a computer by using a parallel or USB cable. ● Clear any stopped jobs from the print queue. ● Print a job that you know works. ● Reinstall the printing software.
The interface cable between the computer (or network) and the printer is not connected properly.	Disconnect and reconnect the interface cable.
The interface cable is defective.	<ul style="list-style-type: none"> ● If possible, connect the interface cable to another computer (or network port) and print a job that you know works. ● Try using a different cable.
If the printer is connected to a computer, the software for the printer is not configured for the printer port.	Check the printer selection menu in the software to make sure that it is using the correct port. If the computer has more than one port, make sure that the printer is associated with the correct one.

Pages print, but not all of the colors print, or the pages are completely blank.

Cause	Solution
If one color is completely missing, the sealing tape might not have been removed completely from the print cartridge.	Remove the print cartridge for the missing color and make sure all the sealing tape has been removed completely.
If pages print completely blank, the file might have blank pages.	Check the file to see if it contains blank pages. Delete those pages if they are unnecessary.
If you are using non-HP print cartridges, one or more print cartridges is low or empty. The control panel lights do not indicate low or empty status for non-HP print cartridges.	Replace one or more of the print cartridges.
The Font DIMM check box might be selected but the font DIMM is not physically installed in the printer. (This issue only applies to printers that are using an Asian-language font DIMM.)	In the settings for this printer, click to clear the Font DIMM check box on the Configure tab if no font DIMM is installed in the printer. Select the Font DIMM check box only if the font DIMM is physically installed in the printer. If you think that the font DIMM is installed, make sure that it is installed correctly.

The media curls when exiting the top output bin.

Cause	Solution
The media needs to print to the straight-through paper path.	Open the rear output door to print to the straight-through paper path. Remove each sheet as it exits the printer.
The stack was slightly curled when it was placed in the tray.	Turn the stack over in the tray.
The print media does not meet specifications.	See Print-media specifications .
If you are printing on light media, the Type setting might not be correct.	Select Light in the Type is field in the printer driver.

The printer prints, but the text is wrong, garbled, or incomplete.

Cause	Solution
The interface cable is loose or defective.	Disconnect the printer cable and reconnect it. Try a print job that you know works. If possible, attach the cable and printer to another computer and try a print job that you know works. Finally, try a new cable.
The printer is on a network or sharing device and is not receiving a clear signal.	Disconnect the printer from the network and attach it directly to a computer by using a parallel or USB cable. Print a job that you know works.
The wrong driver was selected in the software.	In the Print or Printer Setup dialog box, make sure that the HP color LaserJet 2550 printer is selected.
The printer driver is malfunctioning.	Print a page from the HP Toolbox. If the page prints, then the problem is with the printer driver. Uninstall and reinstall the printer driver.
The program is malfunctioning.	Try printing a job from another program.

The printer prints, but the text is wrong, garbled, or incomplete.

Cause	Solution
<p>If the printer is connected to a computer, the operating system is malfunctioning.</p>	<p>Check the operating system. If you do not know how to use the following method, see the documentation that came with the computer.</p> <p>Restart the computer. When it beeps during startup, press F5 and select Command Prompt Only. At the C:\ prompt on the computer, type <code>Dir>LPT1</code> and then press Enter. (This assumes the printer is connected to LPT1.) If the Go light comes on at the printer, press  (Go) to print and eject the page. If the page prints correctly, then the operating system is malfunctioning.</p>
<p>The font DIMM check box might be selected but the font DIMM might not be physically installed in the printer. (This issue only applies to printers with an Asian-language font DIMM installed.)</p>	<ul style="list-style-type: none"> • If the font DIMM is not installed in the printer, open the printer driver and on the Configure tab, and click to clear the Font DIMM check box. • If a font DIMM is installed, the check box should be selected, but make sure that the actual font DIMM is installed correctly in the printer.

Solving PostScript (PS) errors

The following situations are specific to the PS language and might occur when several printer languages are being used.

Note

To receive a printed or an onscreen message when PS errors occur, select this option in the PS printer driver or the HP Toolbox.

The job prints in Courier (the printer default typeface) instead of the typeface that you requested.

Cause	Solution
The requested typeface is not downloaded. A personality switch might have been performed to print a PCL job just before the PS printing job was received.	Download the font that you want, and send the print job again. Verify the type and location of the font. Download the font to the printer, if applicable. See the software documentation for more information.

A PS error-page prints.

Cause	Solution
The print job might not be PS.	Make sure that the print job is a PS job. Check to see whether the program expected a setup or PS header file to be sent to the printer.

A virtual memory (VM) error occurs.

Cause	Solution
This is a PS font error that occurs when you are using several fonts.	<ul style="list-style-type: none">• Select Unlimited Downloadable Fonts from the printer driver.• Simplify the document by reducing the number of graphics or fonts.

A Range Check error occurs.

Cause	Solution
This is a PS font error that occurs when you are using several fonts.	<ul style="list-style-type: none">• Try printing from a different tray.• Select Unlimited Downloadable Fonts from the printer driver.

Solving common Macintosh problems



In addition to the problems that are listed in [Solving general printing problems](#), this section lists problems that can occur when using Mac OS 9.x, or Mac OS X.

Note

The HP color LaserJet 2550 series printer supports USB and Internet protocol (IP) printing by using an Ethernet connection (networked models only). Setup for USB and IP printing is performed through the **Desktop Printer Utility**. The printer will *not* appear in the Chooser.

Problems with Mac OS 9.x.

The printer name or IP address does not show or verify in the Desktop Printer Utility.



Cause	Solution
The printer might not be ready.	Make sure the cables are connected correctly, the printer is on, and the ready light is on. If connecting through a USB or Ethernet hub, try connecting directly to the computer or use a different port.
The wrong connection type might be selected.	Make sure that Printer (USB) or Printer (LPR) is selected in the Desktop Printer Utility , depending on the type of connection that exists between the printer and the computer.
The wrong printer name or IP address is being used.	Check the printer name or IP address by printing a configuration page. (Briefly press  (Go) and  (CANCEL JOB) simultaneously.) Verify that the printer name or IP address on the configuration page matches the printer name or IP address in the Desktop Printer Utility .
The interface cable might be defective or of poor quality.	Replace the interface cable. Make sure to use a high-quality cable.

The PostScript Printer Description (PPD) file for the printer does not appear as a selection in the Desktop Printer Utility

Cause	Solution
The printer software might not have been installed or was installed incorrectly.	Make sure that the HP color LaserJet 2550 PPD is in the following hard drive folder: <code>System folder/Extensions/Printer Descriptions</code> . If necessary, reinstall the software. See the getting started guide for instructions.
The Postscript Printer Description (PPD) file is corrupt.	Delete the PPD file from the following hard drive folder: <code>System Folder/Extensions/Printer Descriptions</code> . Reinstall the software. See the getting started guide for instructions.

Problems with Mac OS 9.x. (continued)

A print job was not sent to the printer that you wanted.

Cause	Solution
The print queue might be stopped.	Restart the print queue. Open the Printing menu in the top menu bar and click Start Print Queue .
The wrong printer name or IP address is being used. Another printer with the same or similar name or IP address might have received your print job.	Check the printer name or IP address by printing a configuration page. (Briefly press  (Go) and  (CANCEL JOB) simultaneously.) Verify that the printer name or IP address on the configuration page matches the printer name or IP address in the Desktop Printer Utility .
The printer might not be ready.	Make sure the cables are connected correctly, the printer is on, and the ready light is on. If connecting through a USB or Ethernet hub, try connecting directly to the computer or use a different port.
The interface cable might be defective or of poor quality.	Replace the interface cable. Make sure to use a high-quality cable.

You cannot use the computer while the printer is printing.

Cause	Solution
Background Printing has not been selected.	For LaserWriter 8.6 and later: Turn Background Printing on by selecting Print Desktop on the File menu and then clicking Background Printing .

An encapsulated PostScript (EPS) file does not print with the correct fonts.

Cause	Solution
This problem occurs with some programs.	<ul style="list-style-type: none">• Try downloading the fonts that are contained in the EPS file to the printer before printing.• Send the file in ASCII format instead of binary encoding.

Your document is not printing with New York, Geneva, or Monaco fonts.

Cause	Solution
The printer might be substituting fonts.	Click Options in the Page Setup dialog box to clear substituted fonts.

You are unable to print from a third-party USB card.

Cause	Solution
This error occurs when the software for USB printers is not installed.	When adding a third-party USB card, you might need the Apple USB Adapter Card Support software. The most current version of this software is available from the Apple website.

Problems with Mac OS 9.x. (continued)

When connected with a USB cable, the printer does not appear in the Desktop Printer Utility or the Apple System Profiler after the driver is selected.

Cause	Solution
This problem is caused by either a software or hardware component.	<p>Software troubleshooting</p> <ul style="list-style-type: none">• Check that your Macintosh supports USB.• Verify that your Macintosh operating system is Mac OS 9.1 or later.• Ensure that your Macintosh has the appropriate USB software from Apple. <hr/> <p>Note</p> <p>The iMac and Blue G3 desktop Macintosh systems meet all of the requirements to connect to a USB device.</p> <hr/> <p>Hardware troubleshooting</p> <ul style="list-style-type: none">• Check that the printer is turned on.• Verify that the USB cable is properly connected.• Check that you are using the appropriate high-speed USB cable.• Ensure that you do not have too many USB devices drawing power from the chain. Disconnect all of the devices from the chain and connect the cable directly to the USB port on the host computer.• Check to see if more than two nonpowered USB hubs are connected in a row on the chain. Disconnect all devices from the chain and connect the cable directly to the USB port on the host computer. <hr/> <p>Note</p> <p>The iMac keyboard is a nonpowered USB hub.</p>



Problems with Mac OS X

The printer driver is not listed in Print Center

Cause	Solution
The printer software might not have been installed or was installed incorrectly.	Make sure that the HP color LaserJet 2550 PPD is in the following hard drive folder: <code>Library/Printers/PPDs/Contents/Resources/<lang>.lproj</code> , where “<lang>” represents the two-letter language code for the language you are using. If necessary, reinstall the software. See the getting started guide for instructions.
The Postscript Printer Description (PPD) file is corrupt.	Delete the PPD file from the following hard drive folder: <code>Library/Printers/PPDs/Contents/Resources/<lang>.lproj</code> , where “<lang>” represents the two-letter language code for the language you are using. Reinstall the software. See the getting started guide for instructions.

Problems with Mac OS X (continued)

The printer name, IP address, or Rendezvous host name does not appear in the printer list box in the print center.



Cause	Solution
The printer might not be ready.	Make sure the cables are connected correctly, the printer is on, and the ready light is on. If connecting through a USB or Ethernet hub, try connecting directly to the computer or use a different port.
The wrong connection type might be selected.	Make sure that USB, IP Printing, or Rendezvous is selected, depending on the type of connection that exists between the printer and the computer.
The wrong printer name, IP address, or Rendezvous host name is being used.	Check the printer name, IP address, or Rendezvous host name by printing a configuration page. (Briefly press  (Go) and  (CANCEL JOB) simultaneously.) Verify that the name, IP address, or Rendezvous host name on the configuration page matches the printer name, IP address, or Rendezvous host name in the Print Center.
The interface cable might be defective or of poor quality.	Replace the interface cable. Make sure to use a high-quality cable.

The printer driver does not automatically set up your selected printer in Print Center.

Cause	Solution
The printer might not be ready.	Make sure the cables are connected correctly, the printer is on, and the ready light is on. If connecting through a USB or Ethernet hub, try connecting directly to the computer or use a different port.
The printer software might not have been installed or was installed incorrectly.	Make sure that the HP color LaserJet 2550 PPD is in the following hard drive folder: <code>Library/Printers/PPDs/Contents/Resources/<lang>.lproj</code> , where “<lang>” represents the two-letter language code for the language you are using. If necessary, reinstall the software. See the getting started guide for instructions.
The Postscript Printer Description (PPD) file is corrupt.	Delete the PPD file from the following hard drive folder: <code>Library/Printers/PPDs/Contents/Resources/<lang>.lproj</code> , where “<lang>” represents the two-letter language code for the language you are using. Reinstall the software. See the getting started guide for instructions.
The printer might not be ready.	Make sure the cables are connected correctly, the printer is on, and the ready light is on. If connecting through a USB or Ethernet hub, try connecting directly to the computer or use a different port.
The interface cable might be defective or of poor quality.	Replace the interface cable. Make sure to use a high-quality cable.

Problems with Mac OS X (continued)

A print job was not sent to the printer that you wanted.

Cause	Solution
The print queue might be stopped.	Restart the print queue. Open print monitor and select Start Jobs .
The wrong printer name or IP address is being used. Another printer with the same or similar name, IP address, or Rendezvous host name might have received your print job.	Check the printer name, IP address, or Rendezvous host name by printing a configuration page. (Briefly press  (Go) and  (CANCEL JOB) simultaneously.) Verify that the name, IP address, or Rendezvous host name on the configuration page matches the printer name, IP address, or Rendezvous host name in the Print Center.

An encapsulated PostScript (EPS) file does not print with the correct fonts.

Cause	Solution
This problem occurs with some programs.	<ul style="list-style-type: none">• Try downloading the fonts that are contained in the EPS file to the printer before printing.• Send the file in ASCII format instead of binary encoding.

You are unable to print from a third-party USB card.

Cause	Solution
This error occurs when the software for USB printers is not installed.	When adding a third-party USB card, you might need the Apple USB Adapter Card Support software. The most current version of this software is available from the Apple website.

Problems with Mac OS X (continued)

When connected with a USB cable, the printer does not appear in the Macintosh Print Center after the driver is selected.

Cause	Solution
This problem is caused by either a software or a hardware component.	<p>Software troubleshooting</p> <ul style="list-style-type: none">• Check that your Macintosh supports USB.• Verify that your Macintosh operating system is Mac OS X version 10.1 or later.• Ensure that your Macintosh has the appropriate USB software from Apple. <p>Hardware troubleshooting</p> <ul style="list-style-type: none">• Check that the printer is turned on.• Verify that the USB cable is properly connected.• Check that you are using the appropriate high-speed USB cable.• Ensure that you do not have too many USB devices drawing power from the chain. Disconnect all of the devices from the chain, and connect the cable directly to the USB port on the host computer.• Check to see if more than two nonpowered USB hubs are connected in a row on the chain. Disconnect all devices from the chain and connect the cable directly to the USB port on the host computer. <hr/> <p>Note</p> <p>The iMac keyboard is a nonpowered USB hub.</p> <hr/>

Resolving problems that generated messages

This section helps resolve problems that generated messages on the computer.

Messages for both Windows and Macintosh

This section lists some common errors that provide only a simple message but no information for resolving the error. Errors that you see in HP Toolbox provide their own instructions for resolving the error. For other errors that are generated by your operating system, see the documentation for the operating system or computer.

Limit Check Error

Cause	Solution
The print job is too complex.	<ul style="list-style-type: none">• You might need to reduce the complexity of the page or install more memory.• Use one of the other printer drivers.• Send the print job in smaller pieces or in fewer pages.

Messages for Windows only

Message	Solution
"Error writing to LPTx" in Windows 98 or Me	<ul style="list-style-type: none">• Make sure that the tray contains print media.• Make sure that the cables are connected correctly, the printer is on, and the Ready light is on.• Print a Demo page from the HP Toolbox to make sure that the computer can communicate with the printer.• On the Start menu, point to Settings and click Printers. Right-click the HP color LaserJet 2550 driver and select Properties. Click Details and then click Port Settings. Clear the Check Port State before Printing check box and click OK. Click Spool Settings, select Print Directly to Printer, and click OK.• Try printing again.

Message	Solution
<p>"General Protection Fault"</p> <p>"Exception OE"</p> <p>"Spool32"</p> <p>"Illegal Operation"</p>	<p>Restart the computer and try again.</p> <p>Clear the contents of the computer Temp folder, which is generally located in C:\Windows (for Windows 98 and Me) or C:\Winnt (for Windows 2000 and XP).</p> <p>Change the graphics mode in the driver from raster to vector, or from vector to raster.</p>
<p>Other Windows messages</p>	<p>For more information, see the Microsoft Windows 98, 2000, Me, or XP documentation that came with the operating system or computer.</p>

Resolving the control panel messages

Printer status is indicated by light patterns on the control panel. Two sets of lights are on the control panel: Supplies Status lights and Printer Status lights:

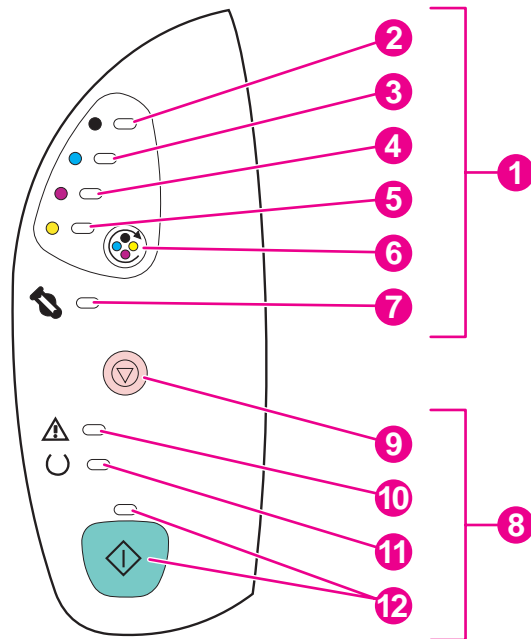

- 1 **Supplies status lights and buttons**
- 2 Black print-cartridge light
- 3 Cyan print-cartridge light
- 4 Magenta print-cartridge light
- 5 Yellow print-cartridge light
- 6 **ROTATE CAROUSEL** button
- 7 Imaging drum light
- 8 **Printer status lights and buttons**
- 9 **CANCEL JOB** button
- 10 Attention light (amber)
- 11 Ready light (green)
- 12 Go light and **Go** button (both green)

The lights can be in any one of the following states:

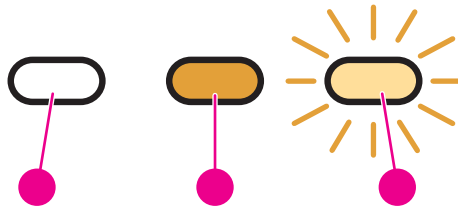





- 1 off
- 2 on
- 3 blinking



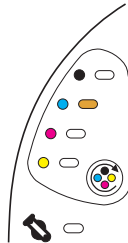
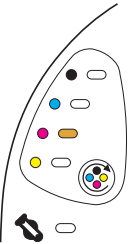
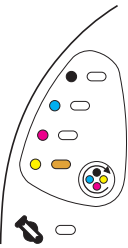
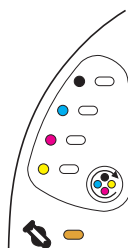

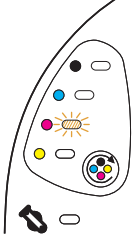

See the following information to interpret control panel lights. See the HP Toolbox to view animations of the light patterns and information about the messages that they indicate.

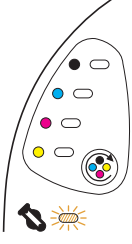

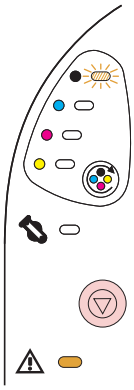

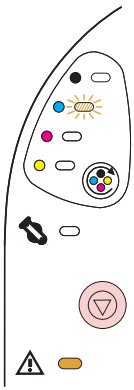
Supplies Status lights

This section describes the meaning of the patterns for the lights in the Supplies Status area. Information about supplies also appears in the HP Toolbox. (For more information, see [Maintenance](#).) To order new supplies, see [Accessories and ordering information](#).

Light pattern	Recommended action
	<p>Black print cartridge is low</p> <p>The black print-cartridge light is on. The printer continues to print without any action required until the print cartridge is empty. Order a new print cartridge.</p>
	<p>Cyan print cartridge is low</p> <p>The cyan print-cartridge light is on. The printer continues to print without any action required until the print cartridge is empty. Order a new print cartridge.</p>
	<p>Magenta print cartridge is low</p> <p>The magenta print-cartridge light is on. The printer continues to print without any action required until the print cartridge is empty. Order a new print cartridge.</p>
	<p>Yellow print cartridge is low</p> <p>The yellow print-cartridge light is on. The printer continues to print without any action required until the print cartridge is empty. Order a new print cartridge.</p>
	<p>Imaging drum is low</p> <p>The imaging-drum light is on. The printer continues to print without any action required until the imaging drum is empty. Order a new imaging drum.</p>

Light pattern	Recommended action
	<p>Black print cartridge is empty or missing</p> <p>The black print-cartridge light is blinking. The printer stops printing.</p> <p>The print cartridge is empty or missing, or the printer cannot detect the print cartridge correctly. You must replace the print cartridge before the printer can continue printing.</p> <p>Reinsert or replace the print cartridge. If the print-cartridge light is still blinking but the Attention light is not on, turn the printer off and then on. If the problem persists, contact HP Customer Care. See HP customer care, or see the flyer that came in the printer box for contact information.</p>
	<p>Cyan print cartridge is empty or missing</p> <p>The cyan print-cartridge light is blinking. The printer stops printing.</p> <p>The print cartridge is empty or missing, or the printer cannot detect the print cartridge correctly. You must replace the print cartridge before the printer can continue printing.</p> <p>Reinsert or replace the print cartridge. If the print-cartridge light is still blinking but the Attention light is not on, turn the printer off and then on. If the problem persists, contact HP Customer Care. See HP customer care, or see the flyer that came in the printer box for contact information.</p>
	<p>Magenta print cartridge is empty or missing</p> <p>The magenta print-cartridge light is blinking. The printer stops printing.</p> <p>The print cartridge is empty or missing, or the printer cannot detect the print cartridge correctly. You must replace the print cartridge before the printer can continue printing.</p> <p>Reinsert or replace the print cartridge. If the print-cartridge light is still blinking but the Attention light is not on, turn the printer off and then on. If the problem persists, contact HP Customer Care. See HP customer care, or see the flyer that came in the printer box for contact information.</p>
	<p>Yellow print cartridge is empty or missing</p> <p>The yellow print-cartridge light is blinking. The printer stops printing.</p> <p>The print cartridge is empty or missing, or the printer cannot detect the print cartridge correctly. You must replace the print cartridge before the printer can continue printing.</p> <p>Reinsert or replace the print cartridge. If the print-cartridge light is still blinking but the Attention light is not on, turn the printer off and then on. If the problem persists, contact HP Customer Care. See HP customer care, or see the flyer that came in the printer box for contact information.</p>
	<p>Imaging drum is empty or missing</p> <p>The imaging-drum light is blinking. The printer stops printing.</p> <p>The imaging drum is empty, missing, or the printer cannot detect the imaging drum correctly. You must replace the imaging drum before the printer can continue printing.</p> <p>Reinsert or replace the imaging drum. If the imaging-drum light is still blinking but the Attention light is not on, turn the printer off and then on. If the problem persists, contact HP Customer Care. See HP customer care, or see the flyer that came in the printer box for contact information.</p>









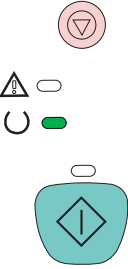

Light pattern	Recommended action
	<p>Black print cartridge is a non-HP print cartridge</p> <p>The black print-cartridge light is blinking and the Attention light is on. The printer stops printing.</p> <p>A non-Hewlett-Packard supply has been detected. Although HP supports customer choice, HP cannot guarantee the quality or reliability of non-HP supplies. Service or repairs required as a result of using a non-Hewlett-Packard supply are not covered under the printer warranty.</p> <p>If you want to use this non-HP print cartridge, press  (CANCEL JOB) to continue printing.</p> <p>To ensure full availability and/or accuracy of printing features (such as remaining supply status), use genuine HP supplies.</p> <p>If you believe you purchased a genuine HP supply, go to http://www.hp.com/go/anticounterfeit.</p>
	<p>Cyan print cartridge is a non-HP print cartridge</p> <p>The cyan print-cartridge light is blinking and the Attention light is on. The printer stops printing.</p> <p>A non-Hewlett-Packard supply has been detected. Although HP supports customer choice, HP cannot guarantee the quality or reliability of non-HP supplies. Service or repairs required as a result of using a non-Hewlett-Packard supply are not covered under the printer warranty.</p> <p>If you want to use this non-HP print cartridge, press  (CANCEL JOB) to continue printing.</p> <p>To ensure full availability and/or accuracy of printing features (such as remaining supply status), use genuine HP supplies.</p> <p>If you believe you purchased a genuine HP supply, go to http://www.hp.com/go/anticounterfeit.</p>
	<p>Magenta print cartridge is a non-HP print cartridge</p> <p>The magenta print-cartridge light is blinking and the Attention light is on. The printer stops printing.</p> <p>A non-Hewlett-Packard supply has been detected. Although HP supports customer choice, HP cannot guarantee the quality or reliability of non-HP supplies. Service or repairs required as a result of using a non-Hewlett-Packard supply are not covered under the printer warranty.</p> <p>If you want to use this non-HP print cartridge, press  (CANCEL JOB) to continue printing.</p> <p>To ensure full availability and/or accuracy of printing features (such as remaining supply status), use genuine HP supplies.</p> <p>If you believe you purchased a genuine HP supply, go to http://www.hp.com/go/anticounterfeit.</p>



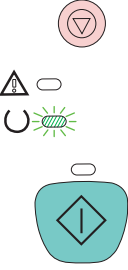

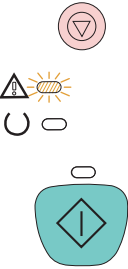
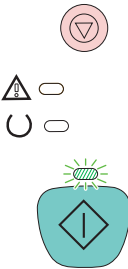



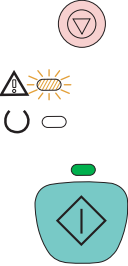

Light pattern	Recommended action
	<p>Yellow print cartridge is a non-HP print cartridge</p> <p>The yellow print-cartridge light is blinking and the Attention light is on. The printer stops printing.</p> <p>A non-Hewlett-Packard supply has been detected. Although HP supports customer choice, HP cannot guarantee the quality or reliability of non-HP supplies. Service or repairs required as a result of using a non-Hewlett-Packard supply are not covered under the printer warranty.</p> <p>If you want to use this non-HP print cartridge, press  (CANCEL JOB) to continue printing.</p> <p>To ensure full availability and/or accuracy of printing features (such as remaining supply status), use genuine HP supplies.</p> <p>If you believe you purchased a genuine HP supply, go to http://www.hp.com/go/anticounterfeit.</p>
	<p>Imaging drum is a non-HP imaging drum</p> <p>The imaging-drum light is blinking and the Attention light is on. The printer stops printing.</p> <p>A non-Hewlett-Packard supply has been detected. Although HP supports customer choice, HP cannot guarantee the quality or reliability of non-HP supplies. Service or repairs required as a result of using a non-Hewlett-Packard supply are not covered under the printer warranty.</p> <p>If you want to use this non-HP print cartridge, press  (CANCEL JOB) to continue printing.</p> <p>To ensure full availability and/or accuracy of printing features (such as remaining supply status), use genuine HP supplies.</p> <p>If you believe you purchased a genuine HP supply, go to http://www.hp.com/go/anticounterfeit.</p>

Printer Status lights

The following section describes the meaning of the light patterns in the Printer Status area. Information about the printer status also appears in the HP Toolbox (For more information, see [HP Toolbox](#).)

Light pattern	Error and recommended action
All control panel lights cycling	<p>Startup</p> <p>All control panel lights cycle one after another. Pressing buttons has no effect until the printer is in the Ready state.</p>

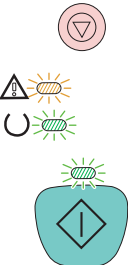
Light pattern	Error and recommended action
	<p>Ready</p> <p>The Ready (green) light is on and the printer is ready to print. No action is needed. Pressing  (Go) prints a Demo page.</p> <p>Pressing  (Go) and  (CANCEL JOB) simultaneously prints a Configuration page and a Supplies Status page, and also an HP Jetdirect page if an HP Jetdirect print server is installed.</p>
	<p>Processing</p> <p>The Ready light is blinking. The printer is receiving or processing data.</p> <p>Pressing  (CANCEL JOB) cancels the current job. One or two pages might print as the printer clears the print job. The printer returns to the Ready state (Ready light on) after the job has been canceled.</p>
	<p>Attention error</p> <p>The Attention light is blinking in these situations:</p> <ul style="list-style-type: none"> • The top cover is open. • The printer is out of print media. • The printer has a jam. <p>For the first cause, close the top cover. For the second cause, load print media. For the last cause, open and close the top cover after you resolve the problem. If the problem is not resolved, the Attention light continues to blink.</p>
	<p>Interaction state</p> <p>The Go light is blinking. The top cover has been opened and then closed, or you pressed  (ROTATE CAROUSEL). Pressing  (Go) returns the printer to the Ready state. If you do not press  (Go), the printer automatically returns to the Ready state on its own. Pressing  (ROTATE CAROUSEL) brings another print cartridge to the top position.</p>

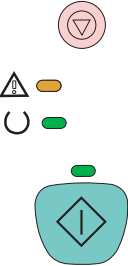
Light pattern	Error and recommended action
	<p>Attention with Ability to Continue</p> <p>The Attention light is blinking and the Go light is on. The printer stops printing. The message appears in these situations:</p> <ul style="list-style-type: none"> • Manual feed with pause. Someone sent a manual feed job and the printer is waiting for the special print media. Load print media into tray 1, and if the printer does not begin printing after the pages are reloaded, press  (Go). Or, just press  (Go) to try to print from another tray. • Manual two-sided printing. The printer has finished printing the first side of a manual duplex job, and the printer is waiting for someone to reload the pages so it can print the second side. Press  (Go) to continue printing. • Paper out in the selected tray. Someone is trying to print by Source (tray) and no print media is in the selected tray. Add print media to that tray to print from it. Or, press  (Go) to try to print from another tray. The printer continues printing. • Print media is the wrong size. The media type does not match the print media that is in the tray. Load the correct size and press  (Go). The printer continues printing. • Continuable state. Press  (Go) for the printer to attempt to recover from the error and print whatever data it can. If successful, the printer completes the job while the Ready light blinks. If unsuccessful, the Attention with Ability to Continue message persists. Press  (CANCEL JOB) to cancel the print job. If the problem has been resolved, the printer returns to the Ready state (Ready light on).
	<p>Accessory error</p> <p>The Attention light, Ready light, and Go light are blinking. The printer stops printing. An error has occurred with either the HP Jetdirect print server or an installed DIMM. Pressing any button has no effect.</p> <p>Press and hold  (Go) to see a secondary light pattern. (See Secondary light patterns for Printer Status lights.)</p>
	<p>Service error</p> <p>The Attention light, Ready light, and Go light are on. The printer stops printing. Pressing any button has no effect. Perform these steps:</p> <ul style="list-style-type: none"> • Turn the printer off and then on. If the problem persists, leave the printer off for 15 minutes to reset the printer. • If the printer is connected to a power strip or surge protector, disconnect it and connect the power cable directly to a working wall outlet. • If the problem continues, contact HP Customer Care. See HP customer care or the support flyer that came in the printer box.

Secondary light patterns for Printer Status lights

This section describes the secondary light patterns that you can display when you experience an Accessory error. Secondary light patterns provide more information about the specific type of error that occurred. To understand the secondary light pattern, perform one of these steps:

- Press and hold  (Go). When the secondary light pattern appears, use this section to identify the associated error. When you release the buttons, the light pattern for the original error appears again.
- View the HP Toolbox, which provides a text message that corresponds to the error and its secondary light pattern.

Secondary light patterns for Accessory errors

This section describes the secondary light patterns that you can view when you experience an Accessory error (Attention light, Ready light, and Go light are blinking).

To see the secondary light pattern, press and hold  (Go).

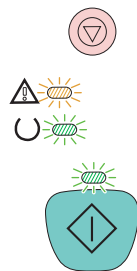

Secondary light patterns for Accessory errors

	<p>53.x1.zz Printer (DIMM Slot 1) error</p> <p>The Go light is on. There is a problem with the DIMM in this DIMM slot.</p> <hr/> <p>CAUTION</p> <p>You must turn off the printer before inserting or removing DIMMs to avoid damaging them.</p> <hr/> <ul style="list-style-type: none">• Remove the DIMM and reinstall it to ensure that it is correctly installed.• Ensure that you are using a supported DIMM. See Accessories and ordering information.• Move the DIMM to a different DIMM slot. If the DIMM works in a different slot, then DIMM slot 1 is malfunctioning. See HP customer care or the support flyer that came in the printer box.• To continue printing, remove the DIMM from DIMM slot 1.
--	---

Clearing jams

Occasionally, paper or other print media can become jammed during a print job. Some causes include the following events:

- The input trays are loaded improperly or overfilled.
- Tray 2 or optional tray 3 is removed during a print job.
- The top cover is opened during a print job.
- Too many sheets accumulated in an output area or sheets blocked an output area.
- The print media that is being used does not meet HP specifications. See [Print-media specifications](#).
- The environment in which the print media was stored is too humid or too dry. See [Print-media specifications](#).

Where to look for jams

Jams can occur in these locations:

- Inside the printer. See [To clear jams from inside the printer](#).
- In input areas. See [To clear jams from input areas](#).
- In output areas. See [To clear jams from output areas](#).

Find and remove the jam by using the instructions on the following pages. If the location of the jam is not obvious, look first inside the printer.

Loose toner might remain in the printer after a jam. This problem should resolve itself after a few sheets have been printed. See [Loose toner](#).

To clear jams from inside the printer

CAUTION

Jams in this area might result in loose toner on the page. If you get toner on your clothes or hands, wash them in cold water. (Hot water will set the toner into the fabric.)

1. Open the top cover.

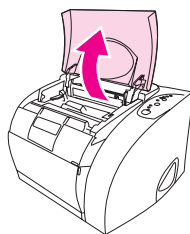

2. Remove the *imaging drum* by pushing it away from you and lifting it out of the printer. You *cannot* reach jams by removing the print cartridges.

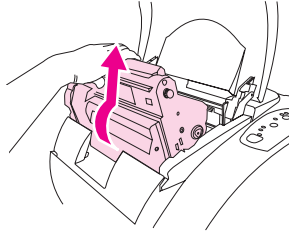

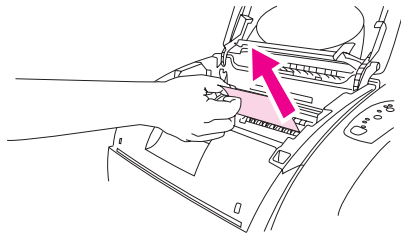

3. Complete one of these steps:

- If the leading edge of the print media is visible, carefully and slowly pull the print media out of the printer.
- If the print media is too difficult to remove, remove the jam as described in [To clear jams from output areas](#).

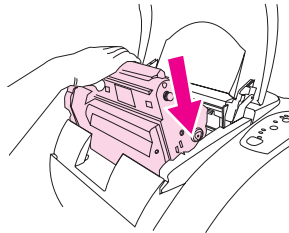

4. After the jam has been removed, replace the imaging drum and close the top cover.



5. Press  (Go) if the Go light is blinking. If the Attention light continues blinking, then another jam is present. See [To clear jams from input areas](#) and [To clear jams from output areas](#).

To clear jams from input areas

1. Open tray 2 or optional tray 3 to expose the jam.

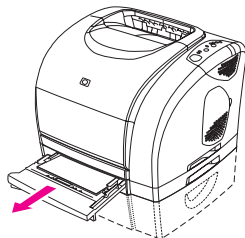

2. Complete one of these steps:

- If the jam has already partially entered the printer, see [To clear jams from inside the printer](#).
- If the jam is only in the input tray, remove the jammed sheet by pulling it out by the visible edge. Realign all of the paper in the tray and go to step 4.

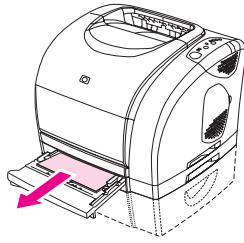

3. If you could not remove the jam from inside the printer or by pulling the sheet out of the tray, grasp the jammed sheet from the outside of the printer and carefully pull it free.

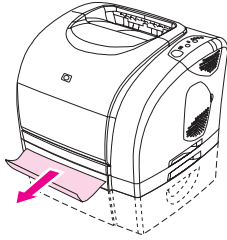

4. Push the paper down to lock the metal paper lift plate into place (tray 2 only) and slide the tray into the printer.

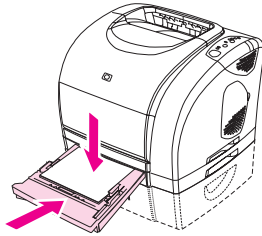

5. After the jammed page has been removed, press  (Go). If the Attention light continues blinking, then another jam is present. See [To clear jams from inside the printer](#) and [To clear jams from output areas](#).

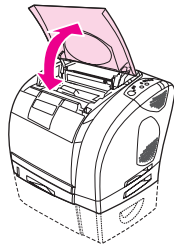

To clear jams from output areas

CAUTION

Jams in these areas might result in loose toner on the page. If you get toner on your clothes or hands, wash them in cold water. (Hot water will set the toner into the fabric.)

1. Complete one of these steps:

- If the jammed media is not almost completely visible from the top output bin, go to step 2.
- If the jammed media is almost completely visible, pull it carefully out of the printer and go to the last step.

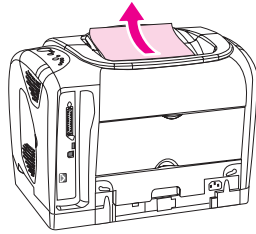

2. Open the rear output door.

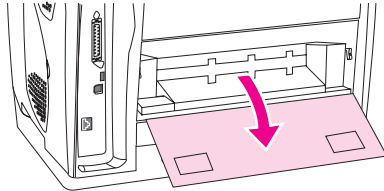

3. If the leading edge of the sheet is visible from the rear opening, push down the two green levers to release the fuser rollers, and carefully pull the sheet out. Close the rear output door.

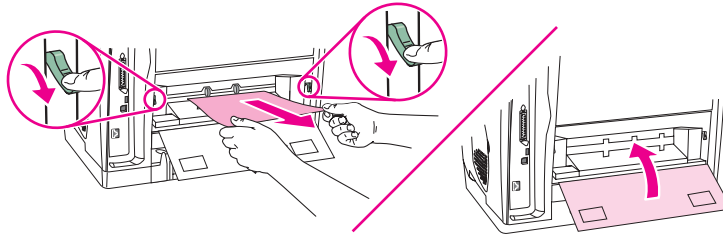

4. If the jam is too far into the printer to remove, turn off the printer and disconnect the power cable.

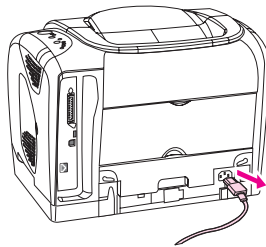

5. Rotate the locks on the fuser to the unlocked position.

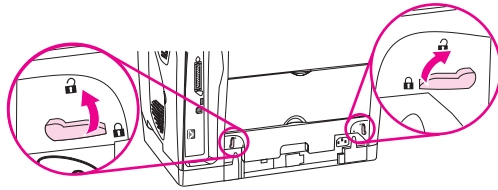

6. Grasp the fuser handles and pull to remove the fuser from the printer.

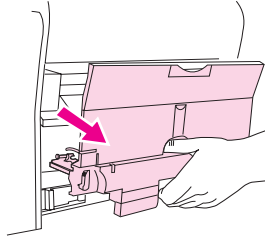

WARNING!

The parts on the internal surface of the fuser are very hot. To avoid burning yourself, do not touch those parts.

7. Using both hands, slowly and steadily remove any print media from inside of the printer. Then, carefully reinsert the fuser and secure the locks.

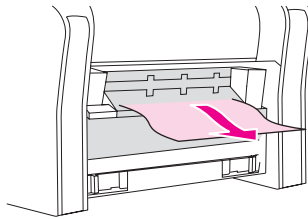

8. Reconnect the power cable and turn on the printer.
9. Open the top cover, close it, and then press  (Go) if the Go light is flashing. If the Attention light is still blinking, then another jam is present. See [To clear jams from inside the printer](#) and [To clear jams from input areas](#).

Solving print-media problems

For best results, make sure that the paper is of good quality, and free of cuts, nicks, tears, spots, loose particles, dust, wrinkles, voids, and curled or bent edges.

For best-quality color printing, use a smooth type of paper. Generally, the smoother the paper, the better the results, although coated and photo papers are not supported. For more information, see [Print-media specifications](#).

If you are unsure what type of paper you are loading (such as bond or recycled), check the label on the package of paper.

The following problems with paper cause print quality deviations, jamming, or even damage to the printer.

Symptom	Problem with paper	Solution
Poor print quality or toner adhesion	The paper is too moist, too rough, too heavy or too smooth, or it is embossed or from a faulty paper lot.	Try another kind of paper, between 100 and 250 Sheffield, 4 to 6 percent moisture content.
Dropouts, jamming, curl	The paper has been stored improperly.	Store paper flat in its moisture-proof wrapping.
	The paper has variability from one side to the other.	Turn the paper over.
Excessive curl	The paper is too moist, has the wrong grain direction, or is of short-grain construction	Open the rear output bin, or use long-grain paper.
	The paper varies from side-to-side.	Turn the paper over.
Jamming, damage to printer	The paper has cutouts or perforations.	Use paper that is free of cutouts or perforations.
Problems with feeding	The paper has ragged edges.	Use high-quality paper that is made for laser printers.
	The paper has variations from one side to the other.	Turn the paper over.
	The paper is too moist, too rough, too heavy or too smooth, has the wrong grain direction, or is of short-grain construction or it is embossed or from a faulty paper lot.	Try another kind of paper, between 100 and 250 Sheffield, 4 to 6 percent moisture content. Open the rear output bin, or use long-grain paper.

- Do not use letterhead paper that is printed with low-temperature inks, such as those used in some types of thermography.
- Do not use raised or embossed letterhead.
- The printer uses heat and pressure to fuse toner to the paper. Make sure that any colored paper or preprinted forms use inks that are compatible with this fusing temperature (210° C or 410° F for 0.1 second).

CAUTION



Failure to follow these guidelines could cause jams or damage to the printer.

Solving print-quality problems

If your document is printing but the quality is not what you expected, start by using the print-quality checklist.







Print-quality checklist

General print-quality problems can be solved by using the following checklist:

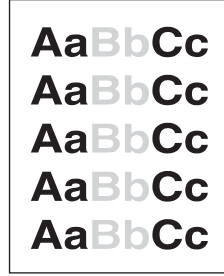
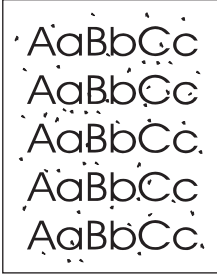
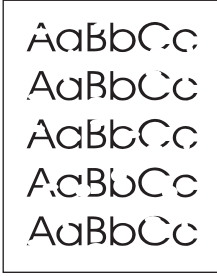
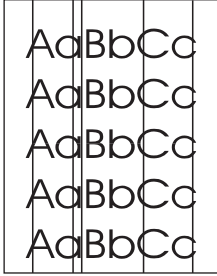
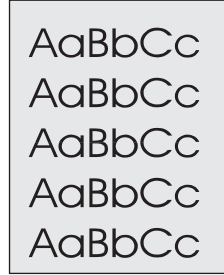
1. Check the printer driver to make sure you are using the best available print-quality option, or return to the default settings. See [Changing the print quality](#).
2. Make sure that the paper or print media that you are using meets specifications. See [Print-media specifications](#). Generally, smoother paper provides better results, although coated and photo papers are not supported.
3. If you are using a special print media such as labels, transparencies, or letterhead, ensure that you have printed by Type. See [Controlling print jobs](#).
4. Print a Configuration page and Supplies Status page at the printer by pressing  (Go) and  (CANCEL JOB) simultaneously.
 - Check the Supplies Status page to see if any supplies are low or empty. No information is provided for non-HP print cartridges.
 - If the pages do not print correctly, the problem is with the hardware. Contact HP Customer Care. See [HP customer care](#) or the flyer that came in the printer box.
5. Print a Demo page from the HP Toolbox. If the page prints, the problem is with the printer driver. Try printing from the other printer driver. For example, if you are using the PCL 6 printer driver, print from the PS printer driver.
6. Try printing from a different program. If the page prints correctly, the problem is with the program from which you were printing.
7. Restart the computer and the printer and try printing again. If the problem is not resolved, choose one of these options:
 - If the problem is affecting all printed pages, see [Solving issues with all printed documents](#).
 - If the problem is affecting only pages printed in color, see [Solving issues with color documents](#).

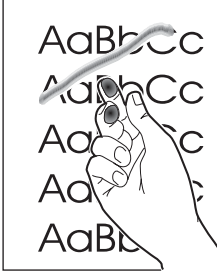
Solving issues with all printed documents

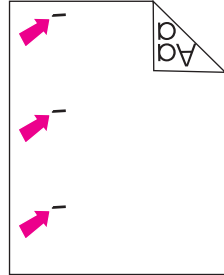
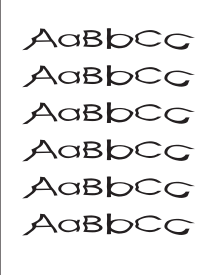
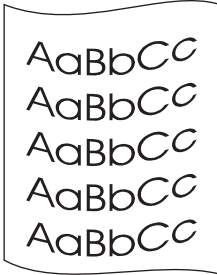
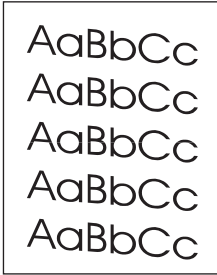
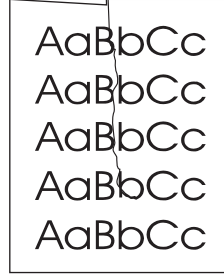
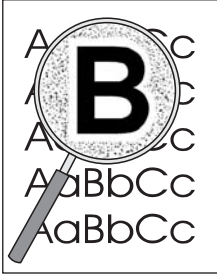
The following examples depict letter-size paper that has passed through the printer short-edge first. These examples illustrate problems that would affect all pages that you print, whether you print in color or in black only. The topics that follow list the typical cause and solution for each of these examples.

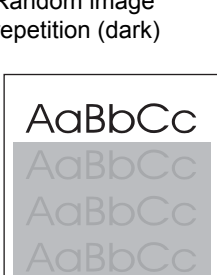
			
Light print or fade	Toner specks	Dropouts	Vertical lines
			
Gray background	Toner smear	Loose toner	Repetitive defects on the front
			
Repetitive defects on the back	Misformed characters	Curl or wave	Page skew
			
Wrinkles or creases	Toner scatter outline	Random image repetition (light)	Random image repetition (dark)

Light print or fade

A vertical streak or an incorrect or faded color area appears on the page.

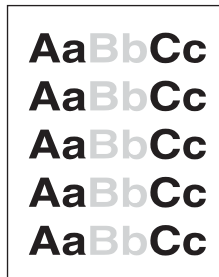

- The print media might not meet HP specifications (for example, the paper is too moist or too rough). See [Print-media specifications](#).
- One or more print cartridges are low. If you are using non-HP print cartridges, no messages appear on the printer control panel or in the HP Toolbox.
- The imaging drum might be low or empty. Print the Supplies Status page to check the remaining life. Replace the imaging drum if it is low or empty.
- If none of the print cartridges or the imaging drum is low or empty, remove the print cartridges one at a time and inspect the toner roller in each to see if the roller is damaged. If so, replace the print cartridge.
- If the light printing is on the left side of the page, the carousel might be dislocated. Service is required.
- If the problem is not resolved, see [If the problem is not resolved](#).

Toner specks

Specks of toner occur randomly on the page.

- The print media might not meet HP specifications. For example, the paper is too moist or too rough. See [Print-media specifications](#).

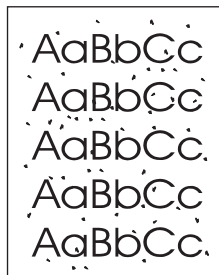

- The paper path might need cleaning. See [Cleaning the printer](#).
- If the problem is not resolved, see [If the problem is not resolved](#).

Dropouts

Faded areas, generally rounded, occur randomly on the page.

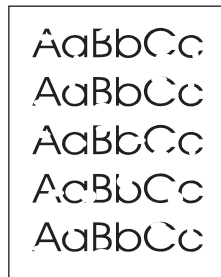

- A single sheet of print media might be defective. Try reprinting the job.
- The moisture content of the paper is uneven or the paper has moist spots on its surface. Try different paper, such as high-quality paper intended for laser printers. See [Print-media specifications](#).
- The paper lot is flawed. The manufacturing processes can cause some areas to reject toner. Try a different brand of paper, such as high-quality paper intended for laser printers. See [Print-media specifications](#).
- The imaging drum might be defective. See [Repetitive defects on the front](#).
- If these steps do not correct the problem, contact HP Customer Care. See [HP customer care](#) or the support flyer that came in the printer box.
- If the problem is not resolved, see [If the problem is not resolved](#).

Vertical lines

Vertical streaks or bands appear on the page.

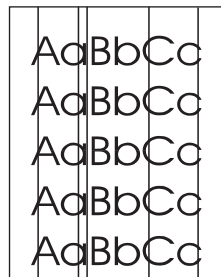

- One or more print cartridges are low or defective. Print the Supplies Status page to check the remaining life. If you are using non-HP print cartridges, no messages appear on the printer control panel or in the HP Toolbox.
- Clean the printer by using a cleaning page. See [Cleaning the printer](#).
- Use the tools on the **Troubleshooting** tab of the HP Toolbox to correct the problem.
- If the problem is not resolved, see [If the problem is not resolved](#).

Gray background

The amount of background toner shading becomes unacceptable.



- Perform a calibration. See [Calibrating the printer](#).
- Use a different paper with a lighter basis weight. See [Print-media specifications](#).
- Check the printer environment. Very dry (low humidity) conditions can increase the amount of background shading.
- One or more print cartridges are low. If you are using non-HP print cartridges, no messages appear on the printer control panel or in the HP Toolbox.
- The imaging drum might be low or empty. Print the Supplies Status page to check remaining life. Replace the imaging drum if it is low or empty.
- If the problem is not resolved, see [If the problem is not resolved](#).

Toner smear

Toner smears appear on the leading edge of the paper.



- Check the print media type and quality. Use a different media, such as high-quality paper intended for laser printers. See [Print-media specifications](#).
- If toner smears appear on the leading edge of the paper, the media guides are dirty, or debris has accumulated in the print path. See [Cleaning the printer](#).
- The imaging drum might be low or empty. Check the status of the imaging drum by using the printer control panel or the HP Toolbox and replace the imaging drum if it is low or empty.
- If the problem is not resolved, see [If the problem is not resolved](#).

Loose toner

The toner smears easily when touched.

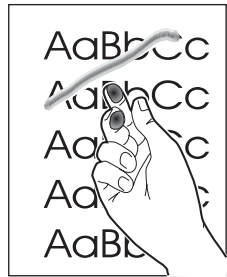

- In the printer driver, select the **Paper** tab and set **Type is** to match the type of media on which you are printing. Print speed might be slower if you are using heavy paper.
- Check the paper type and quality. Use a different paper, such as high-quality paper intended for laser printers. See [Print-media specifications](#).
- Clean the inside of the printer. See [Cleaning the printer](#).
- The fuser might be damaged. Contact HP Customer Care. See [HP customer care](#) or the support flyer that came in the printer box.
- If the problem is not resolved, see [If the problem is not resolved](#).

Repetitive defects on the front

Marks repeatedly appear at even intervals on the printed side of the page.

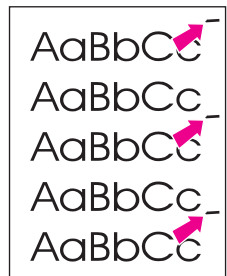

- In the printer driver, select the **Paper** tab and set **Type is** to match the type of paper on which you are printing. Print speed might be slower if you are using heavy paper.
- Clean the printer. See [Cleaning the printer](#).
- Use the tools on the **Troubleshooting** tab of the HP Toolbox to correct the problem.
- The imaging drum might be defective. Replace the imaging drum.
- The fuser might be damaged. Contact HP Customer Care. See [HP customer care](#) or the support flyer that came in the printer box.
- If the problem is not resolved, see [If the problem is not resolved](#).

Repetitive defects on the back

Marks repeatedly appear at even intervals on the unprinted side of the page.

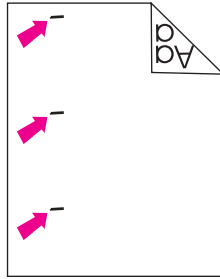

- Internal parts might have toner on them. The problem will likely correct itself after a few more pages.
- Clean the printer. See [Cleaning the printer](#).
- The fuser might be damaged. Contact HP Customer Care. See [HP customer care](#) or the support flyer that came in the printer box.
- If the problem is not resolved, see [If the problem is not resolved](#).

Misformed characters

The printed page contains misformed characters.

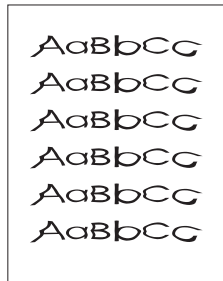

- If characters are improperly formed so that they produce hollow images, the paper might be too slick of a paper, such as a photo, glossy, or coated paper. Use a different paper, such as high-quality paper intended for laser printers. See [Print-media specifications](#).
- If characters are improperly formed so that they produce a wavy effect, the laser scanner might need service. Verify that the problem also occurs on the Configuration page. If so, contact HP Customer Care. See [HP customer care](#) or the support flyer that came in the printer box.
- If the problem is not resolved, see [If the problem is not resolved](#).

Curl or wave

The printed page is curled or wavy.

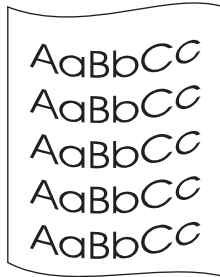

- Turn over the stack of paper in the tray. Also try rotating the paper 180 degrees in the input tray.
- Set the correct Type in the printer driver. Heavier paper might take longer to print.
- Open the rear output door to print to the straight-through paper path.
- Check the paper type and quality. Both high temperature and humidity will cause paper curl. Use a different paper, such as high-quality paper intended for laser printers. See [Print-media specifications](#).
- If the problem is not resolved, see [If the problem is not resolved](#).

Page skew

Text or graphics are skewed on the printed page.

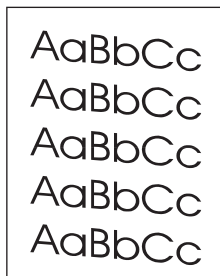

- Make sure that the paper or other print media is loaded correctly and that the media guides are not too tight or too loose against the stack. See [Loading trays](#).
- Check the paper type and quality. Use a different paper, such as high-quality paper intended for laser printers. See [Print-media specifications](#).
- If the problem is not resolved, see [If the problem is not resolved](#).

Wrinkles or creases

The printed page contains wrinkles or creases.

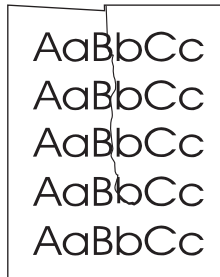

- Make sure that paper is loaded properly.
- Turn over the stack of paper in the input tray, or try rotating the paper 180 degrees in the input tray.
- Open the rear output door to print to the straight-through paper path.
- Check the paper type and quality. Use a different paper, such as high-quality paper intended for laser printers. See [Print-media specifications](#).
- If the problem is not resolved, see [If the problem is not resolved](#).

Toner scatter outline

Toner appears around the printed characters.

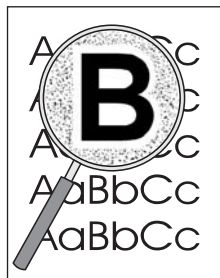

- Small amounts of toner scatter are normal for laser printing.
- Turn over the stack of paper in the tray.
- Perform a calibration. See [Calibrating the printer](#).
- If large amounts of toner have scattered around the characters, the paper might have high resistivity. Use a different paper, such as high-quality paper intended for laser printers. See [Print-media specifications](#).
- If the problem is not resolved, see [If the problem is not resolved](#).

Random image repetition

If an image that appears at the top of the page (in solid black) repeats farther down the page (in a gray field), the toner might not have been completely erased from the last job. The repeated image might be lighter or darker than the field in which it appears.



- In your program, change the tone (darkness) of the field that the repeated image appears in.
- In your program, rotate the whole page 180 degrees to print the lighter image first.
- Change the order in which the images are printed. For example, have the lighter image at the top of the page, and the darker image farther down the page.
- If the defect occurs later in a print job, turn the printer off for 10 minutes, and then turn the printer on to restart the print job.
- If the problem is not resolved, see [If the problem is not resolved](#).

If the problem is not resolved

If the problem is not resolved, try these steps:





1. Perform a cleaning and calibration. See [Cleaning the printer](#).
2. Print the Configuration page and Supplies Status page again.
 - If the pages print correctly, then the problem is with the program, computer, or printer driver. Go to the next step.
 - If the pages do not print correctly, then the problem is with the printer itself. The problem might be the fuser. Contact HP Customer Care. See [HP customer care](#) or the support flyer that came in the printer box.
3. Change the Type setting in the printer driver, or change the print mode in the HP Toolbox. If this step does not help, go to the next step.
4. If the problem persists, check the paper type and quality. (See [Print-media specifications](#).) Use a different paper, such as high-quality paper intended for laser printers. Coated and photo papers are not supported.
5. Print to a different printer.
 - If the page prints correctly, then the problem is with the printer driver. Uninstall the printer driver and reinstall it.
 - If the page does not print correctly, the problem is with the program or the computer. See the documentation for the program or the computer.

Solving issues with color documents

This section describes issues that can occur when you print in color.

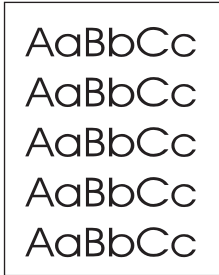
Note

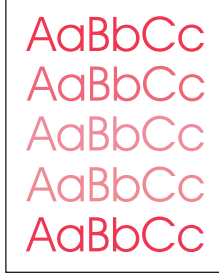
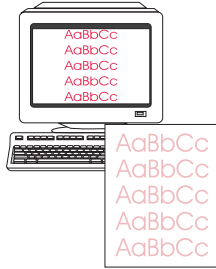
Whenever you are experiencing color-related issues, calibrate the printer before trying any other steps. See [Calibrating the printer](#).

<p>Only black prints</p> 	 <p>Missing or incorrect color</p>	 <p>Color prints inconsistently</p>	<p>Colors do not match</p> 
<p>Color pages have inconsistent finish</p> 			

Only black prints

Only black is printing when the document should be printing in color.

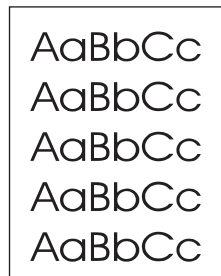

- Color mode is not selected in your program or printer driver. Select color mode instead of grayscale mode.
- The correct printer driver is not selected in the program. Select the correct printer driver.
- The printer is not properly configured. Verify the printer configuration by printing a Configuration page. If no color appears on the Configuration page, contact HP Customer Care. See [HP customer care](#) or the support flyer that came in the printer box.

Missing or incorrect color

One or more colors are not printing, or are inaccurate.



- Perform a calibration. See [Calibrating the printer](#).
- You have changed the color settings manually. Return the color setting to Automatic. See [Changing the color settings](#).
- Make sure that the sealing tape has been completely removed from the print cartridge.
- Turn the printer off and then on again.
- Your print media does not meet the specifications for this printer. Use a different paper, such as a high-quality paper intended for laser printers. See [Print-media specifications](#).
- You are operating the printer in excessively humid conditions. Verify that the printer environment is within humidity specifications.
- A print cartridge might be low. Check the printer control panel, print a Supplies Status page, or view the HP Toolbox to see supplies status. (If you are using a non-HP cartridge, none of these sources will provide information about a low or empty print cartridge.) Replace the print cartridge if it is low or empty.

Color prints inconsistently

A color is printing inconsistently after you load a new print cartridge.

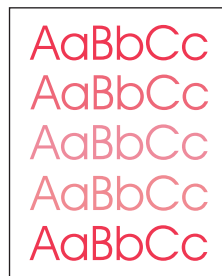

- Another print cartridge might be low. Check the supplies status lights or HP Toolbox to see if a print cartridge is low and replace it if necessary. If you are using a non-HP print cartridge, it might be low or empty but you will receive no indication.
- Print cartridges might be improperly installed. Remove the print cartridge for the color that is printing inconsistently and reinstall it.

Colors do not match

The colors on the printed page do not match the colors as they appear on the screen.



- Perform a calibration. See [Calibrating the printer](#).
- The colors on your computer monitor differ from the printer output. Try selecting **Screen Match** in the **Color** tab of the printer driver.
- Print the Configuration and Supplies Status pages to ensure that they print correctly. If not, the problem is with the printer.
- Try printing from a different program or one of the other printer drivers. For example, if you are using the PCL 6 printer driver, try the PS printer driver.
- Extremely light colors or extremely dark colors on screen are not printing. Your program might interpret extremely light colors as white or extremely dark colors as black. If so, avoid using extremely light or extremely dark colors.
- Other factors, such as the light or paper quality, are affecting the output. Use a different paper, such as a high-quality paper intended for laser printers. See [Print-media specifications](#) and [Using color](#).

Color pages have inconsistent finish

The finish on the printed color page is inconsistent.



- Use a smooth paper or print media, such as a high-quality paper made for laser printers. Generally, the smoother the paper, the better the results. Coated and photo papers are not supported. See [Print-media specifications](#).

A

Accessories and ordering information

The following list of accessories was current at the time of printing. Ordering information and availability of the accessories might change during the life of the printer. For the most current ordering information, visit the most appropriate of the following websites:

- North America: <http://www.hp.com/go/ordersupplies-na>
- Europe and Middle East: <http://www.hp.com/go/ordersupplies-emea>
- Asia Pacific countries/regions: <http://www.hp.com/go/ordersupplies-ap>
- Latin America: <http://www.hp.com/go/ordersupplies-la>

Supplies

Product name	Description	Part number
Black print cartridge	Life of 5,000 pages at 5 percent coverage.	Q3960A
Cyan print cartridge	Life of 4,000 pages at 5 percent coverage.	Q3961A
Yellow print cartridge	Life of 4,000 pages at 5 percent coverage.	Q3962A
Magenta print cartridge	Life of 4,000 pages at 5 percent coverage.	Q3963A
Cyan print cartridge	Life of 2,000 pages at 5 percent coverage.	Q3971A
Yellow print cartridge	Life of 2,000 pages at 5 percent coverage.	Q3972A
Magenta print cartridge	Life of 2,000 pages at 5 percent coverage.	Q3973A
Imaging drum	Imaging drum life is 20,000 pages if printing black only; 5,000 pages if printing in color. Typical life is 6,000 to 8,000 pages.	Q3964A

Memory

Product name	Description	Part number
Memory upgrades (DIMMs)	The standard 64 MB of memory in the printer can be expanded to up to 192 MB using the additional DIMM slot. 32 MB	C7845A
Memory upgrades (DIMMs)	64 MB	C7846A
Memory upgrades (DIMMs)	128 MB	C9121A
Font DIMM (100-pin)	You can install an 8-MB language font ROM in the DIMM slot.	Visit http://www.hp.com for DIMM availability and ordering.

Cable and interface accessories

Product name	Description	Part number
HP Jetdirect external print server	HP Jetdirect 170x Ethernet (10Base-T, RJ-45); parallel connection	J3258B
HP Jetdirect external print server	HP Jetdirect 175x Ethernet (10 Base-T RJ-45); Fast Ethernet (10/100Base-TX RJ-45); USB connection	J6035C
HP Jetdirect external print server	HP Jetdirect 300x Ethernet/ Fast Ethernet (10/100Base-TX, RJ-45); parallel connection	J3263A
HP Jetdirect external print server	HP Jetdirect 500x Ethernet, Fast Ethernet (10/100Base-TX RJ-45); parallel connection	J3264A
HP Jetdirect external print server	HP Jetdirect en3700 external print server (10/100Base-TX); USB 2.0 high speed connection	J7942A
Parallel cables (IEEE-1284)	2-meter, size B	C2950A
Parallel cables (IEEE-1284)	3-meter, size B	C2951A
USB cable	2-meter standard USB-compatible device connector	C6518A

Paper handling accessories

Product name	Description	Part number
Optional tray 2	<p>250-sheet input tray for standard sizes. Only one 250-sheet tray can be installed.</p> <hr/> <p>Note</p> <p>This tray is included with the <u>HP color LaserJet 2550n printer.</u></p>	Q3709A
Optional tray 3	<p>500-sheet input tray for letter and A4 sizes. Only one 500-sheet tray can be installed. You must have a 250-sheet optional tray 2 installed to install an optional tray 3.</p>	Q3710A

Paper and other print media

Product name	Description	Part number
HP LaserJet paper	Premium HP-brand paper for use with HP LaserJet printers.	HPJ1124 (letter)
HP LaserJet paper	Premium HP-brand paper for use with HP LaserJet printers.	CHP310 (A4)
HP LaserJet paper	Premium HP-brand paper for use with HP LaserJet printers.	HPJ1424 (legal)
HP Premium Choice paper	HP bond paper with a weight of 120.32 g/m ² (32 lb.)	HPU1132 (letter)
HP Premium Choice paper	HP bond paper with a weight of 120.32 g/m ² (32 lb.)	CHP410 (A4)
HP Premium Cover paper	HP-brand paper with a weight of 200 g/m ² (75-lb cover). Use for printing postcards and document covers.	Q2413A (letter) 100 sheets
HP Premium Cover paper	HP-brand paper with a weight of 200 g/m ² (75-lb cover). Use for printing postcards and document covers.	Q2414A (A4) 100 sheets
HP Printing paper	HP-brand paper for use with HP LaserJet printers.	HPP1122 (letter)
HP Printing paper	HP-brand paper for use with HP LaserJet printers.	CHP210 (A4)
HP Multipurpose paper	HP-brand paper for a variety of uses.	HPM1120 (letter)
HP Multipurpose paper	HP-brand paper for a variety of uses.	HPM1420 (legal)
HP LaserJet Tough paper	Robust paper with a satin finish. Paper will not tear and will withstand the weather. For documents requiring durability and longevity.	Q1298A (letter)
HP LaserJet Tough paper	Robust paper with a satin finish. Paper will not tear and will withstand the weather. For documents requiring durability and longevity.	Q1298B (A4)
HP High Gloss laser paper	High-gloss finish coating on both sides. Use for brochures, catalogs, photographs, and whenever a high-gloss finish is desired.	Q2419A (letter) 200 sheets

Product name	Description	Part number
HP High Gloss laser paper	High-gloss finish coating on both sides. Use for brochures, catalogs, photographs, and whenever a high-gloss finish is desired.	Q2421A (A4) 200 sheets
HP Soft Gloss laser paper (heavy)	Satin finish coating on both sides. 120 g/m ² (32 lb)	Q4179A (letter) 200 sheets
HP Soft Gloss laser paper (heavy)	Satin finish coating on both sides. 120 g/m ² (32 lb)	C4179B (A4) 200 sheets
HP Soft Gloss laser paper	Satin finish coating on both sides. 105 g/m ² (28 lb)	Q2415A (letter) 500 sheets
HP Soft Gloss laser paper	Satin finish coating on both sides. 105 g/m ² (28 lb)	Q2417A (A4) 500 sheets
HP color LaserJet transparencies	Use color transparencies for full-color printing.	C2934A (letter) 50 sheets
HP color LaserJet transparencies	Use color transparencies for full-color printing.	C2936A (A4) 50 sheets

User-replaceable parts

Product name	Description	Part number
Fuser	Replace when print-quality issues remain after you have cleaned the engine and tried all troubleshooting measures. (See Cleaning the printer and Solving print-quality problems .)	Contact HP Customer Care to order parts.
Separation pad and pick-up rollers	Replace when the printer is picking up multiple sheets or no sheets. Trying different paper did not resolve the problem.	Contact HP Customer Care to order parts.

Supplementary Documentation

A printed copy of this user guide is available in the following languages.

User guides

Language	Part number
English	Q3702-90905
Arabic	Q3702-90901
Chinese, simplified	Q3702-90917
Czech	Q3702-90902
Danish	Q3702-90903
Dutch	Q3702-90904
Finnish	Q3702-90906
French	Q3702-90907
German	Q3702-90908
Hebrew	Q3702-90909
Hungarian	Q3702-90910
Italian	Q3702-90911
Korean	Q3702-90912
Norwegian	Q3702-90913
Portuguese, Brazilian	Q3702-90914
Polish	Q3702-90915
Russian	Q3702-90916
Spanish, Castilian	Q3702-90918
Swedish	Q3702-90919
Thai	Q3702-90921
Traditional Chinese	Q3702-90920
Turkish	Q3702-90922

B

Service and support

Hewlett-Packard limited warranty statement

HP PRODUCT

HP color LaserJet 2550L, 2550Ln, 2550n

DURATION OF LIMITED WARRANTY

1 year, Return to Authorized Service Center

HP warrants to you, the end-user customer, that HP hardware and accessories will be free from defects in materials and workmanship after the date of purchase, for the period specified above. If HP receives notice of such defects during the warranty period, HP will, at its option, either repair or replace products which prove to be defective. Replacement products may be either new or equivalent in performance to new.

HP warrants to you that HP software will not fail to execute its programming instructions after the date of purchase, for the period specified above, due to defects in material and workmanship when properly installed and used. If HP receives notice of such defects during the warranty period, HP will replace software which does not execute its programming instructions due to such defects.

HP does not warrant that the operation of HP products will be uninterrupted or error free. If HP is unable, within a reasonable time, to repair or replace any product to a condition as warranted, you will be entitled to a refund of the purchase price upon prompt return of the product.

HP products may contain remanufactured parts equivalent to new in performance or may have been subject to incidental use.

Warranty does not apply to defects resulting from (a) improper or inadequate maintenance or calibration, (b) software, interfacing, parts or supplies not supplied by HP, (c) unauthorized modification or misuse, (d) operation outside of the published environmental specifications for the product, or (e) improper site preparation or maintenance.

TO THE EXTENT ALLOWED BY LOCAL LAW, THE ABOVE WARRANTIES ARE EXCLUSIVE AND NO OTHER WARRANTY OR CONDITION, WHETHER WRITTEN OR ORAL, IS EXPRESSED OR IMPLIED AND HP SPECIFICALLY DISCLAIMS ANY IMPLIED WARRANTIES OR CONDITIONS OF MERCHANTABILITY, SATISFACTORY QUALITY, AND FITNESS FOR A PARTICULAR PURPOSE. Some countries/regions, states or provinces do not allow limitations on the duration of an implied warranty, so the above limitation or exclusion might not apply to you. This warranty gives you specific legal rights and you might also have other rights that vary from country/region to country/region, state to state, or province to province. HP's limited warranty is valid in any country/region or locality where HP has a support presence for this product and where HP has marketed this product. The level of warranty service you receive may vary according to local standards. HP will not alter form, fit or function of the product to make it operate in a country/region for which it was never intended to function for legal or regulatory reasons.

TO THE EXTENT ALLOWED BY LOCAL LAW, THE REMEDIES IN THIS WARRANTY STATEMENT ARE YOUR SOLE AND EXCLUSIVE REMEDIES. EXCEPT AS INDICATED ABOVE, IN NO EVENT WILL HP OR ITS SUPPLIERS BE LIABLE FOR LOSS OF DATA OR FOR DIRECT, SPECIAL, INCIDENTAL, CONSEQUENTIAL (INCLUDING LOST PROFIT OR DATA), OR OTHER DAMAGE, WHETHER BASED IN CONTRACT, TORT, OR OTHERWISE. Some countries/regions, states or provinces do not allow the exclusion or limitation of incidental or consequential damages, so the above limitation or exclusion may not apply to you.

THE WARRANTY TERMS CONTAINED IN THIS STATEMENT, EXCEPT TO THE EXTENT LAWFULLY PERMITTED, DO NOT EXCLUDE, RESTRICT OR MODIFY AND ARE IN ADDITION TO THE MANDATORY STATUTORY RIGHTS APPLICABLE TO THE SALE OF THIS PRODUCT TO YOU.

Print Cartridge Limited Warranty Statement

This HP Print Cartridge is warranted to be free from defects in materials and workmanship.

This warranty does not apply to print cartridges that (a) have been refilled, refurbished, remanufactured or tampered with in any way, (b) experience problems resulting from misuse, improper storage, or operation outside of the published environmental specifications for the printer product or (c) exhibit wear from ordinary use.

To obtain warranty service, please return the product to place of purchase (with a written description of the problem and print samples) or contact HP customer support. At HP's option, HP will either replace products that prove to be defective or refund your purchase price.

TO THE EXTENT ALLOWED BY LOCAL LAW, THE ABOVE WARRANTY IS EXCLUSIVE AND NO OTHER WARRANTY OR CONDITION, WHETHER WRITTEN OR ORAL, IS EXPRESSED OR IMPLIED AND HP SPECIFICALLY DISCLAIMS ANY IMPLIED WARRANTIES OR CONDITIONS OF MERCHANTABILITY, SATISFACTORY QUALITY, AND FITNESS FOR A PARTICULAR PURPOSE.

TO THE EXTENT ALLOWED BY LOCAL LAW, IN NO EVENT WILL HP OR ITS SUPPLIERS BE LIABLE FOR DIRECT, SPECIAL, INCIDENTAL, CONSEQUENTIAL (INCLUDING LOST PROFIT OR DATA), OR OTHER DAMAGE, WHETHER BASED IN CONTRACT, TORT, OR OTHERWISE.

THE WARRANTY TERMS CONTAINED IN THIS STATEMENT, EXCEPT TO THE EXTENT LAWFULLY PERMITTED, DO NOT EXCLUDE, RESTRICT OR MODIFY AND ARE IN ADDITION TO THE MANDATORY STATUTORY RIGHTS APPLICABLE TO THE SALE OF THIS PRODUCT TO YOU.

Availability of support and service

Around the world, HP provides a variety of service and support options for purchase. Availability of these programs will vary depending upon your location.

HP maintenance agreements

HP has several types of maintenance agreements that meet a wide range of support needs. Maintenance agreements are not part of the standard warranty. Support services vary by location. Contact HP Customer Care to determine the services available to you and for more information about maintenance agreements. In general, the printer will have the following maintenance agreements:

Onsite service agreements

To provide you with the level of support best suited to your needs, HP has on-site service agreements with two response times:

Priority Onsite Service

This agreement provides 4-hour service response to your site for calls made during normal HP business hours.

Next-Day Onsite Service

This agreement provides support by the next working day following a service request. Extended coverage hours and extended travel beyond HP's designated service zones are available on most on-site agreements (for additional charges).

HP Express Exchange (U.S. and Canada only)

This service, available for an additional fee, is an alternative to the standard warranty and entails returning your printer for repair. HP Express Exchange allows you to receive a refurbished replacement unit and then return your defective printer. The fast turnaround from HP Express Exchange minimizes downtime over traditional service programs that require you to ship the defective printer to the manufacturer and then wait for the printer to be repaired and returned.

If you choose to use this service, follow the steps listed below. If you have HP on-site support service, you should work directly with the local HP Customer Care center instead of following the steps outlined here.

Note

To identify potential support options for this printer, go to <http://www.hpexpress-services.com/10467a> and type the printer model number. In North America, additional options might be available through HP Customer Care. Call 1-800-HPINVENT [(1) (800) 474-6836 (U.S.)] or (1) (800) 268-1221 (Canada).

To use HP Express Exchange

1. Call the HP Customer Care Center for the U.S. or Canada. A technician troubleshoots the situation and determines whether the printer has actually failed. If so, the technician refers the customer to the HP Service Center.
2. A representative from the service center requests product and customer information. In some cases, collateral might also be requested.
3. Before agreeing to use this service, check with the representative for information about returning your defective printer.
4. HP ships a refurbished replacement unit to arrive the next day. (Geographic distance might prevent next-day shipping.)

Exchanged units carry the remainder of the original unit's warranty or 90 days, whichever is greater.

Repacking the printer

If HP Customer Care determines that your printer needs to be returned to HP for repair, follow the steps below to repack the printer before shipping it.

CAUTION

Shipping damage as a result of inadequate packing is the customer's responsibility.

To repack the printer

1. Remove and retain any DIMMs installed in the printer.

CAUTION

Static electricity can damage DIMMs. When handling DIMMs, either wear an antistatic wrist strap, or frequently touch the surface of the DIMM antistatic package and then touch bare metal on the printer. To remove the DIMMs, see [Installing memory and font DIMMs](#)

2. Remove and retain the imaging drum.
3. Remove and retain all four print cartridges. The easiest way to remove the print cartridges is with the printer plugged in and turned on, as follows:
 - a. Open the top cover and remove the print cartridge that is in the access position.
 - b. Close the top cover and press  (ROTATE CAROUSEL).
 - c. Open the top cover and remove the print cartridge that is now in the access position.
 - d. Repeat steps b and c to remove the two remaining print cartridges.

If the printer is cannot be turned on, remove the print cartridges manually by using the following procedure:

CAUTION

Do not attempt to perform the following procedure with the printer turned on. Doing so could damage the printer. Make sure the printer is turned off and the power cord is disconnected before manually removing the print cartridges.

- a. Open the top cover. Locate the white plastic guide that is underneath the top-cover hinge on the right side of the printer.

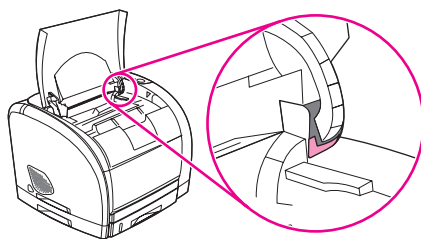

- b. Insert a small pointed object, such as a small screwdriver or an extended paper clip, into the hole in the white guide. Push toward the back of the printer. This releases the carousel so it can rotate freely.

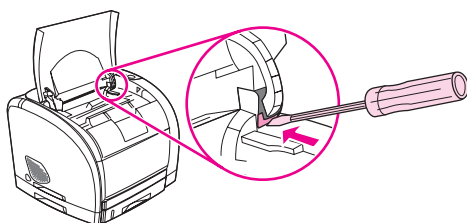

- c. Remove each print cartridge, rotating the carousel as necessary. Be careful not touch the rollers on the print cartridges.

CAUTION

It is *extremely important* to remove the print cartridges before shipping the printer. Print cartridges that are left in the printer during shipping will leak and entirely cover the printer engine and other parts with toner.

To prevent damage to the print cartridge, avoid touching the roller on it, and store the print cartridge in its original packing material or so that it is not exposed to light.

-
4. If the problem does not involve optional tray 2 or optional tray 3, remove and retain the tray or trays.
 5. Remove and retain the power cable, interface cable, and optional accessories.
 6. Remove and retain the optional HP Jetdirect external print server, if you have one.
 7. If possible, include print samples and 50 to 100 sheets of paper or other print media that did not print correctly.
 8. Include a completed copy of the [Service information form](#).
 9. In the U.S., call HP Customer Care to request new packing material. In other areas, use the original packing material, if possible. Hewlett-Packard recommends insuring the equipment for shipment.

Service information form

WHO IS RETURNING THE EQUIPMENT?		Date:
Person to contact:		Phone:
Alternate contact:		Phone:
Return shipping address:	Special shipping instructions:	
WHAT ARE YOU SENDING?		
Model name:	Model number:	Serial number:
Please attach any relevant printouts. Do NOT ship accessories (manuals, cleaning supplies, etc.) that are not required to complete the repair.		
HAVE YOU REMOVED THE PRINT CARTRIDGES AND IMAGING DRUM?		
You must remove them before shipping the printer, unless a mechanical problem prevents you from doing so.		
<input type="checkbox"/> Yes.	<input type="checkbox"/> No, I cannot remove them.	
WHAT NEEDS TO BE DONE? (Attach a separate sheet if necessary.)		
1. Describe the conditions of the failure. (What was the failure? What were you doing when the failure occurred? What software were you running? Is the failure repeatable?)		
2. If the failure is intermittent, how much time elapses between failures?		
3. If the unit connected to any of the following, give the manufacturer and model number.		
Personal computer:	Modem:	Network:
4. Additional comments:		
HOW WILL YOU PAY FOR THE REPAIR?		
<input type="checkbox"/> Under warranty	Purchase/received date:	
(Attach proof of purchase or receiving document with original received date.)		
<input type="checkbox"/> Maintenance contract number:		
<input type="checkbox"/> Purchase order number:		
Except for contract and warranty service, a purchase order number and/or authorized signature must accompany any request for service. If standard repair prices do not apply, a minimum purchase order is required. Standard repair prices can be obtained by contacting an HP-authorized repair center.		
Authorized signature:		Phone:
Billing address:	Special billing instructions:	



Specifications

Printer specifications

Physical specifications

Product	Height	Depth	Width	Weight
HP color LaserJet 2550L printer without optional trays	325 mm (12.80 in)	451 mm (17.76 in)	482 mm (18.98 in)	21.5 kg (47.5 lbs)
HP color LaserJet 2550n printer with tray 2 (250-sheet)	376 mm (14.80 in)	451 mm (17.76 in)	482 mm (18.98 in)	23.9 kg (52.7 lbs)
HP color LaserJet 2550n printer with tray 2 and optional tray 3 (500-sheet)	512 mm (20.16 in)	451 mm (17.76 in)	482 mm (18.98 in)	29.3 kg (64.6 lbs)

Supplies specifications

Imaging-drum life (based on 5 percent coverage)	20,000 pages when printing only in black 5,000 pages when printing in color 6,000 to 8,000 pages is the average life
Print-cartridge life (based on 5 percent coverage)	Black: 5,000 pages Yellow, cyan, and magenta: 2,000 pages each (HP color LaserJet 2550L printer) Yellow, cyan, and magenta: 4,000 pages each (HP color LaserJet 2550Ln and 2550n printers)

Electrical specifications

Item	110-volt models	220-volt models
Power supply	115 to 127 V (+/- 10 %)	220 to 240 V (+/- 10 %)
	50 to 60 Hz (+/- 2 Hz)	50 to 60 Hz (+/- 2 Hz)
Power consumption (typical)		
During printing (color)	224 W (average)	217 W (average)
During printing (black and white)	400 W (average)	400 W (average)
During standby	15 W (average)	19 W (average)
Off mode	0 W (average)	0 W (average)
Heat output		
Idle	51 BTU/hr	61 BTU/hr
Minimum recommended circuit capacity	12 A	6 A

CAUTION

Power requirements are based on the country/region where the printer is sold. Do not convert operating voltages. This will damage the printer and void the product warranty.

Environmental specifications

	Recommended ¹	Operating ¹	Storage ¹
(printer and print cartridge) Temperature	20° to 27° C (68° to 81° F)	15° to 32.5° C (59° to 90.5° F)	-20° to 40° C (-4° to 104° F)
Relative humidity	20 to 70 percent	10 to 80 percent	95 percent or less

¹Values are subject to change. See <http://www.hp.com/support/clj2550> for current information.

Acoustic emissions (HP color LaserJet 2550 series)

Sound Power Level	Declared per ISO 9296 ¹
Printing (20 ppm)	$L_{WAd} = 6.6$ Bels (A) [66 dB (A)]
SPL-Bystander Position	Declared per ISO 9296 ¹
Printing (20 ppm)	$L_{pAm} = 52$ dB(A)

¹Values are subject to change. See <http://www.hp.com/support/clj2550> for current information.

D

Regulatory information

Introduction

This section contains the following regulatory information:

- [FCC regulations](#)
- [Environmental Product Stewardship program](#)
- [Material safety data sheet](#)
- [Declaration of conformity](#)
- [Laser safety statement](#)
- [Canadian DOC statement](#)
- [Korean EMI statement](#)
- [Finnish laser statement](#)

FCC regulations

This equipment has been tested and found to comply with the limits for a Class B digital device, pursuant to Part 15 of the FCC rules. These limits are designed to provide reasonable protection against harmful interference in a residential installation. This equipment generates, uses, and can radiate radio frequency energy. If this equipment is not installed and used in accordance with the instructions, it may cause harmful interference to radio communications. However, there is no guarantee that interference will not occur in a particular installation; the presence of interference can be determined by turning the equipment off and on. If this equipment does cause harmful interference to radio or television communications, the user is encouraged to try to correct the interference by one or more of the following measures:

- Reorient or relocate the receiving antenna.
- Increase distance between equipment and receiver.
- Connect equipment to an outlet on a circuit different from that to which the receiver is located.
- Consult your dealer or an experienced radio/television technician.

Note

Any changes or modifications to the printer that are not expressly approved by HP could void the user's authority to operate this equipment.

Use of a shielded interface cable is required to comply with the Class B limits of Part 15 of FCC rules.

Environmental Product Stewardship program

Protecting the environment

Hewlett-Packard Company is committed to providing quality products in an environmentally sound manner. This product has been designed with several attributes to minimize impacts on our environment.

Ozone production

This product generates no appreciable ozone gas (O₃).

Energy consumption

This product qualifies for ENERGY STAR®, which is a voluntary program established to encourage the development of energy-efficient office products.



ENERGY STAR is a U.S. registered service mark of the U.S. Environmental Protection Agency. As an ENERGY STAR® partner, Hewlett-Packard Company has determined that this product meets ENERGY STAR® Guidelines for energy efficiency. For more information, see <http://www.energystar.gov>

Paper use

The manual duplex feature [two-sided printing; see [Printing on both sides \(duplexing manually\)](#)] and N-up printing capability [multiple pages printed on one sheet; see [Printing multiple pages on one sheet of paper \(N-up printing\)](#)] can reduce paper usage and the resulting demands on natural resources.

Plastics

Plastic parts over 25 grams are marked according to international standards that enhance the ability to identify plastics for recycling purposes at the end of the product's life.

HP LaserJet printing supplies

In many countries/regions, this product's printing supplies (for example, print cartridge, imaging drum) can be returned to HP through the HP Printing Supplies Returns and Recycling Program. An easy-to-use and free takeback program is available in over 48 countries/regions. Multi-lingual program information and instructions are included in every new HP LaserJet print cartridge and supplies package.

HP Printing Supplies Returns and Recycling Program Information

Since 1990, the HP Printing Supplies Returns and Recycling Program has collected millions of used HP LaserJet print cartridges that otherwise may have been discarded in the world's landfills. The HP LaserJet print cartridges and supplies are collected and bulk shipped to our resource and recovery partners who disassemble the cartridge. After a thorough quality inspection, selected parts are reclaimed for use in new cartridges. Remaining materials are separated and converted into raw materials for use by other industries to make a variety of useful products.

U.S. returns

For a more environmentally responsible return of used cartridges and supplies, HP encourages the use of bulk returns. Simply bundle two or more cartridges together and use the single, pre-paid, pre-addressed UPS label that is supplied in the package. For more information in the U.S., call (1) (800) 340-2445 or visit the HP Printing Supplies Returns and Recycling Program website at: <http://www.hp.com/go/recycle>.

Non-U.S. returns

Non-U.S. customers should call the local HP Sales and Service Office or visit the <http://www.hp.com/go/recycle> website for further information regarding availability of the HP Printing Supplies Returns and Recycling Program.

Paper

This product is capable of using recycled papers, when the paper meets the guidelines outlined in the *HP LaserJet Printer Family Print Media Guide*. Go to <http://www.hp.com/support/ljpaperguide> to download this guide in PDF format. This product is suitable for the use of recycled paper according to DIN 19309.

Material restrictions

This product does not contain added mercury.

This product does not contain batteries.

This HP product contains lead in solder that may require special handling at end-of-life.

For recycling information, you can contact <http://www.hp.com/go/recycle> or contact your local authorities or the Electronics Industry Alliance: <http://www.eiae.org>.

Material safety data sheet

Material Safety Data Sheets (MSDS) can be obtained by contacting the HP LaserJet Supplies website at <http://www.hp.com/hpinfo/community/environment/productinfo/safety.htm>.

Extended warranty

HP SupportPack provides coverage for the HP hardware product and all HP supplied internal components. The hardware maintenance covers a three-year period from the date of the HP product purchase. The customer must purchase HP SupportPack within 90 days of the HP product purchase. For more information, contact the HP Customer Care Service and HP Customer Support Group. See [HP customer care](#).

Spare parts and supplies availability

Spare parts and consumable supplies for this product will be available for at least five years after production has stopped.

For more information

On HP's environmental programs, including:

- Product environmental profile sheet for this and many related HP products
- HP's commitment to the environment
- HP's environmental management system
- HP's end-of-life product return and recycling program
- Material Safety Data Sheets

See: <http://www.hp.com/go/environment> or <http://www.hp.com/hpinfo/community/environment>

Declaration of conformity

Declaration of Conformity

according to ISO/IEC Guide 22 and EN 45014

Manufacturer's Name: Hewlett-Packard Company
Manufacturer's Address: 11311 Chinden Boulevard
Boise, Idaho 83714-1021, USA

declares, that the product

Product Name: HP color LaserJet 2550L/2550Ln/2550n
Regulatory Model Number⁴⁾: BOISB-0305-00. Including: Q3709A – Optional 250-sheet input tray; Q3710A – Optional 500-sheet input tray
Product Options: ALL

conforms to the following Product Specifications:

Safety: IEC 60950:1999 / EN60950: 2000
IEC 60825-1:1993 +A1: 1997 +A2:2001 / EN 60825-1:1994 +A11:1996 +A2:2001 (Class 1 Laser/LED Product)
GB4943-2001

EMC: CISPR 22:1997 / EN 55022:1998 Class B^{1) 3)}
EN 61000-3-2:1995 / A14
EN 61000-3-3:1995/ A1
EN 55024:1998
FCC Title 47 CFR, Part 15 Class B²⁾ / ICES-003, Issue 3/ GB9254-1998, GB17625.1-1998 / CNS 13438

Supplementary Information:

The product herewith complies with the requirements of the EMC Directive 89/336/EEC and the Low Voltage Directive 73/23/EEC, and carries the CE-Marking accordingly.

- 1) The product was tested in a typical configuration with Hewlett-Packard Personal Computer Systems. Compliance testing of product to standard with exception of Clause 9.5, which is not yet in effect.
- 2) This Device complies with Part 15 of the FCC Rules. Operation is subject to the following two conditions: (1) this device may not cause harmful interference, and (2) this device must accept any interference received, including interference that may cause undesired operation.
- 3) This product includes LAN (Local Area Network) options. When the interface cable is attached to LAN connectors, the product meets the requirements of EN55022 & CNS13438 Class A in which case the following applies: "Warning — This is a class A product. In a domestic environment this product may cause radio interference in which case the user may be required to take adequate measures."
- 4) For regulatory purposes, this product is assigned a Regulatory model number. This number should not be confused with the product name or the product number(s).

Boise, Idaho , USA

1 April, 2004

For regulatory topics only:

Australia Contact: Product Regulations Manager, Hewlett-Packard Australia Ltd., 31-41 Joseph Street Blackburn, Victoria 3130, Australia

European Contact: Your Local Hewlett-Packard Sales and Service Office or Hewlett-Packard GmbH, Department HQ-TRE / Standards Europe, Herrenberger Strasse 140 , D-71034, Böblingen (FAX: +49-7031-14-3143)

USA Contact: Product Regulations Manager, Hewlett-Packard Company, PO Box 15, Mail Stop 160 Boise, Idaho 83707-0015, (Phone: 208-396-6000)

Country-/region-specific safety statements

Laser safety statement

The Center for Devices and Radiological Health (CDRH) of the U.S. Food and Drug Administration has implemented regulations for laser products manufactured since August 1, 1976. Compliance is mandatory for products marketed in the United States. The printer is certified as a "Class 1" laser product under the U.S. Department of Health and Human Services (DHHS) Radiation Performance Standard according to the Radiation Control for Health and Safety Act of 1968.

Since radiation emitted inside the printer is completely confined within protective housings and external covers, the laser beam cannot escape during any phase of normal user operation.

WARNING!

Using controls, making adjustments, or performing procedures other than those specified in this user guide may result in exposure to hazardous radiation.

Canadian DOC statement

Complies with Canadian EMC Class B requirements.

«Conforme à la classe B des normes canadiennes de compatibilité électromagnétiques (CEM).»

Korean EMI statement

사용자 안내문 (B 급 기기)

이 기기는 비업무용으로 전자파장해검정을 받은 기기로서, 주거지역에서는 물론 모든 지역에서 사용할 수 있습니다.

Finnish laser statement

LASERTURVALLISUUS

LUOKAN 1 LASERLAITE

KLASS 1 LASER APPARAT

HP color LaserJet 2550L, 2550Ln, 2550n -laserkirjoitin on käyttäjän kannalta turvallinen luokan 1 laserlaite. Normaalisissa käytössä kirjoittimen suojakotelointi estää lasersäteiden pääsyn laitteen ulkopuolelle.

Laitteen turvallisuusluokka on määritetty standardin EN60825-1 (1994) mukaisesti.

VAROITUS!

Laitteen käyttäminen muulla kuin käyttöohjeessa mainitulla tavalla saattaa altistaa käyttäjän turvallisuusluokan 1 ylittävälle näkymättömälle lasersäteilylle.

WARNING!

Om apparaten används på annat sätt än i bruksanvisning specificerats, kan användaren utsättas för osynlig laserstrålning, som överskrider gränsen för laserklass 1.

HUOLTO

HP color LaserJet 2550L, 2550Ln, 2550n -kirjoittimen sisällä ei ole käyttäjän huollettavissa olevia kohteita. Laitteen saa avata ja huoltaa ainoastaan sen huoltamiseen koulutettu henkilö. Tällaiseksi huoltotoimenpiteeksi ei katsota väriainekasetin vaihtamista, paperiradan puhdistusta tai muita käyttäjän käsikirjassa lueteltuja, käyttäjän tehtäväksi tarkoitettuja ylläpitotoimia, jotka voidaan suorittaa ilman erikoistyökaluja.

VARO!

Mikäli kirjoittimen suojakotelo avataan, olet alttiina näkymättömälle lasersäteilylle laitteen ollessa toiminnassa. Älä katso säteeseen.

WARNING!

Om laserprinterns skyddshölje öppnas då apparaten är i funktion, utsättas användaren för osynlig laserstrålning. Betrakta ej strålen.

Tiedot laitteessa käytettävän laserdiodin säteilyominaisuuksista:

Aallonpituus 770-800 nm

Teho 5 mW

Luokan 3B laser

E

Working with memory

This section provides information about the following topics:

- [Printer memory](#)
- [Installing memory and font DIMMs](#)
- [Checking DIMM installation](#)
- [Enabling memory](#)
- [Enabling the language-font DIMM](#)



Printer memory

The HP color LaserJet 2550 series printer has one dual inline memory module (DIMM) slot for upgrading the printer capabilities with the following options:

- More printer memory. DIMMs are available in 32, 64, and 128 MB for a maximum of 160 MB.
- DIMM-based accessory fonts, macros, and patterns.

You might want to add more memory to the printer if you often print complex graphics or PS documents, or use many downloaded fonts. Additional memory also allows the printer to print multiple, collated copies at the maximum speed.

Before ordering additional memory, see how much is currently installed by printing a

Configuration page. [Press  (Go) and  (CANCEL JOB) simultaneously, or use the HP Toolbox.] To order DIMMs, see [Accessories and ordering information](#). Single inline memory modules (SIMMs) used on previous HP LaserJet printers are not compatible with the printer.



Installing memory and font DIMMs

You can install more memory for the printer, and you can also install a font DIMM to print characters for languages such as Chinese, or for the Cyrillic alphabet.

CAUTION

Static electricity can damage DIMMs. When handling DIMMs, wear an antistatic wrist strap, or frequently touch the surface of the DIMM antistatic package and then touch bare metal on the printer.

To install memory and font DIMMs

1. Print a Configuration page by pressing  (Go) and  (CANCEL JOB) simultaneously. (A Supplies Status page and possibly an HP Jetdirect Configuration page also print.) If the Configuration page does not print in your language, see [Special pages](#).
2. After the Configuration page prints, turn the printer off and disconnect the power cable.

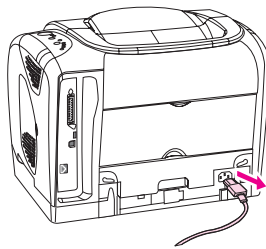

3. On the right side of the printer, open the DIMM door.

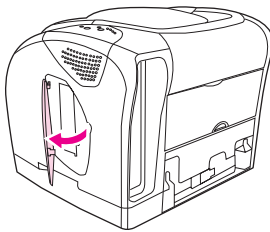

4. Open the second DIMM door.

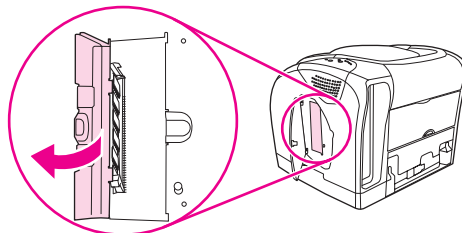

5. Release the locks on each side of the DIMM slot.

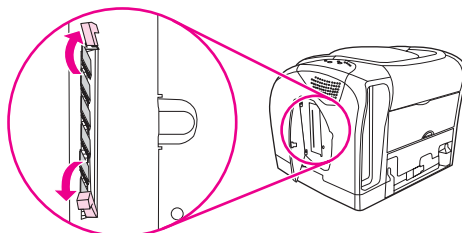

6. Remove the DIMM from the antistatic package.

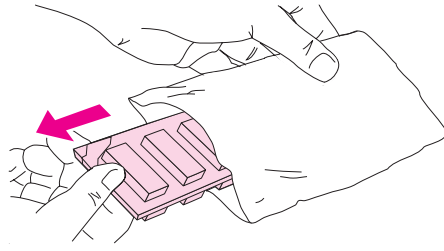

7. Holding the DIMM by the edges as shown in the illustration, align the notches on the DIMM with the DIMM slot.

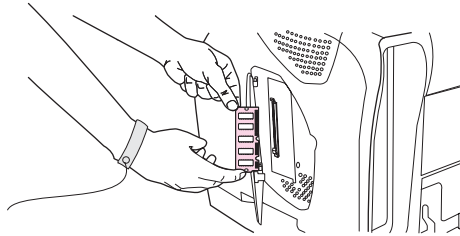

8. Firmly press the DIMM straight into the slot. Firmly close the locks on each side of the DIMM until they snap into place.

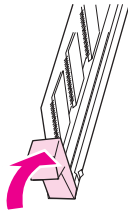

9. Close the two DIMM doors.

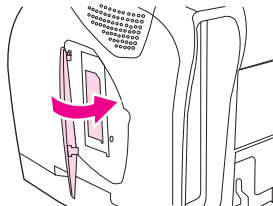

10. Reconnect the power cable and turn the printer on.

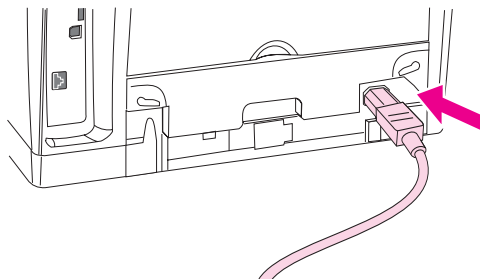



11. Go to [Checking DIMM installation](#).

Checking DIMM installation

Check that the DIMMs are installed correctly and working.

To check DIMM installation

1. Turn the printer on. Check that the Ready light is on after the printer has completed the startup sequence. If an error message appears, a DIMM might have been incorrectly installed.
2. Print a Configuration page by pressing  (Go) and  (CANCEL JOB) simultaneously. (A Supplies Status page and possibly an HP Jetdirect Configuration page also print.)
3. Check the Installed Personalities and Options section on the Configuration page and compare it with the Configuration page printed before the DIMM installation.
4. If the amount of recognized memory has not increased or the font DIMM is not recognized, the following conditions might exist:
 - The DIMM might not be installed correctly. Repeat the installation procedure.
 - The DIMM might be defective. Try installing a different DIMM.
5. After you have installed the DIMM correctly, go to [Enabling memory](#) if you installed a memory DIMM or [Enabling the language-font DIMM](#) if you installed a language-font DIMM.

Enabling memory

If the printer has a new memory DIMM installed, all Windows users of the printer must set the printer driver to recognize the newly added memory. Macintosh computers automatically recognize new memory.

To enable memory for Windows

1. On the **Start** menu, point to **Settings**, and click **Printers** or **Printers and Faxes**.
2. Select this printer and select **Properties**.
3. On the **Configure** tab, click **More**.
4. In the **Total Memory** field, type the total amount of memory that is now installed.
5. Click **OK**.

To enable memory for Mac OS

Note

Enabling memory for OS X might differ from the following procedure.

1. Click the desktop printer icon.
2. From the **Printing** menu, select **Change Setup**.

Enabling the language-font DIMM

If the printer has a new language-font DIMM installed, all Windows users of the printer must set the printer driver to recognize the newly installed font DIMM. Macintosh computers automatically recognize new language font DIMMs.

To enable fonts for Windows

1. On the **Start** menu, point to **Settings**, and click **Printers**.
2. Select this printer and select **Properties**.
3. On the **Configure** tab, click **More**.
4. Select the **Font DIMM** check box.
5. Click **OK**.

Index

Symbols/Numerics

- 250-sheet tray. *See* tray 2
- 4-Color option 65
- 500-sheet tray. *See* tray 3

A

- accessories
 - errors 97, 98
 - part numbers 120
- Adaptive Halftoning options 65
- adding paper 28
- adhesive labels
 - output path 41
 - printing 43
 - specifications 20, 21
- agreements, maintenance 132, 143
- Alerts tab, HP Toolbox 57
- Apple LaserWriter 8 driver 14
- Apple Macintosh. *See* Macintosh
- applications, settings 12
- Attention light 24, 96, 119
 - See also* lights

B

- background, gray 109
- bands, troubleshooting 108
- battery specifications 142
- bins, output
 - features 7
 - jams, clearing 102
 - locating 9
 - selecting 41
 - troubleshooting curl 80
- black and white printing
 - selecting 38
 - troubleshooting 115
- Black cartridge
 - empty or missing, light messages 93
 - life expectancy 68
 - low 92
 - non-HP 94
 - part number 120
 - status light 24, 92
 - See also* cartridges
- Black Only option 65
- blank pages, troubleshooting 80

- blinking lights
 - accessory error messages 98
 - consumables status messages 92
 - printer status messages 96
 - printer status secondary messages 98
- both sides, printing on 48
- browser requirements 55
- buttons, control panel 23

C

- cables
 - connecting 9
 - part numbers 122
 - troubleshooting 79
- calibrating printer 72
- Cancel Job button 24, 50
- capacity
 - output bins 41
- cardstock
 - printing on 41, 46
 - specifications 21
- cartridges
 - empty or missing, light messages 93
 - HP fraud hotline 70
 - life expectancy 68
 - low 92
 - non-HP 94
 - part numbers 120
 - recycling 141
 - replacing 69
 - status lights 24, 92
 - status page, printing 53
 - storage specifications 138
- characters, troubleshooting 111
- clearing jams
 - common locations 99
 - input areas 100
 - inside printer 99
 - output areas 102
- color
 - calibration 72
 - features 62
 - grayscale, printing as 38
 - HP ImageREt 2400 62
 - Manual adjustment options 64
 - matching 66

- settings, changing 64
- sRGB 66
- troubleshooting 114
- Configuration page
 - printing 52
- configurations, printer 4
- connecting cables 9
- consumables
 - availability 143
 - life expectancies 68
 - part numbers 120
 - recycling 141
 - specifications 137
 - status lights 24, 92
 - status page, printing 53
- continuable attention errors 97
- contracts, maintenance 132, 143
- control panel
 - accessory error lights 98
 - consumables status 92
 - lights and buttons, description 23
 - lights and messages, troubleshooting 91
 - printer status lights 95
 - secondary printer status lights 98
- Courier font 82
- covers, document
 - cardstock, printing on 41, 46
 - paper specifications 21
 - using different paper for 40
- covers, printer 9
- creases, troubleshooting 113
- crooked pages 112
- curl, troubleshooting 80, 112
- custom paper sizes 37, 46
- customer support
 - HP Express Exchange 133
 - maintenance agreements 132, 143
 - repacking printer 134
 - service information form 136
- Cyan cartridge
 - empty or missing, light messages 93
 - life expectancy 68
 - low 92
 - non-HP 94
 - part number 120
 - status light 24, 92
 - See *also* cartridges

D

- declaration of conformity 144
- default settings, restoring 40
- deleting print jobs 50
- Demo page, printing 52
- Detail halftone option 64
- Device Settings, HP Toolbox 58
- different first page 40
- digital cameras, color matching 66

- dimensions, media. See sizes, media
- dimensions, printer 137
- DIMMs
 - adding 148
 - enabling 152
 - font, settings 80
 - installing 149
 - part numbers 121
 - slot errors 98
 - verifying installation 151
- documentation 58, 127
- Documentation tab, HP Toolbox 58
- dots per inch (dpi)
 - HP ImageREt 2400 62
 - settings 40
 - specifications 6
 - troubleshooting print quality 105
- dots, troubleshooting 107
- double-sided printing 48
- downloading drivers 12
- dpi (dots per inch)
 - HP ImageREt 2400 62
 - settings 40
 - specifications 6
 - troubleshooting print quality 105
- driver
 - troubleshooting 74
- drivers
 - downloading 12
 - features 36
 - Macintosh 14
 - opening 33
 - operating systems supported 11
 - restoring default settings 40
 - settings, changing 35
 - uninstalling 14
 - Windows, features 13
- dropouts, troubleshooting 108
- drum, imaging
 - empty, light messages 93
 - life expectancy 68
 - low 92
 - non-HP 95
 - part number 120
 - status light 24
- duplexing 48

E

- Edge Control 65
- electrical specifications 138
- energy consumption 138, 141
- engine, cleaning 71
- enlarging documents 39
- envelopes
 - output path 41
 - printing 42
 - specifications 18, 21

- environmental
 - features 141
 - paper specifications 18
 - printer specifications 138
- EPS files, troubleshooting 84
- error messages
 - accessory 98
 - consumables status lights 92
 - Macintosh 89
 - printer status 95
 - secondary, printer status 98
- expansion, memory 148
- Explorer, versions supported 55
- Express Exchange, HP 133
- extended warranty 132, 143

F

- face down bin. See top output bin
- face up bin. See rear output door
- faded print 107
- FCC statements 140
- features
 - color 62
 - drivers 36
 - printer 4
- film, transparency. See transparencies
- first page, different 40
- Fit to Page option 39
- font DIMMs
 - enabling 153
 - installing 149
 - part numbers 121
 - settings 80
 - See *a/so* DIMMs
- fonts
 - included 7
 - troubleshooting 82, 84
- fraud hotline 70
- fuser, ordering 126
- 4-Color option 65

G

- glossy paper
 - printing 45
- Go light and button 25
- gray background, troubleshooting 109
- grayscale printing
 - selecting 38
 - troubleshooting 115

H

- halftone options 64
- heavy paper
 - printing on 41, 46
 - specifications 21

- Help
 - printer drivers 36
 - See *a/so* customer support
- HP Express Exchange 133
- HP fraud hotline 70
- HP ImageREt 2400 62
- HP Jetdirect print servers
 - information page, printing 52
 - part numbers 122
 - troubleshooting 76
- HP LaserJet paper 124
- HP multipurpose paper 124
- HP Printing Supplies Returns and Recycling Program 141
- HP SupportPack 132, 143
- HP Toolbox
 - calibrating printer 72
 - device settings 58
 - operating systems supported 11
 - toner level, checking from 69
 - using 55
- HP Web Jetadmin
 - operating systems supported 11
 - toner level, checking from 69
 - using 13
- humidity specifications
 - paper, storing 18
 - printer environment 138

I

- IBM OS/2 support 11
- image quality
 - HP ImageREt 2400 62
 - settings 40
 - troubleshooting 105
- ImageREt 2400 62
- imaging drum
 - empty, light messages 93
 - life expectancy 68
 - low 92
 - non-HP 95
 - part number 120
 - status light 24
- information pages, printing 52
- ink cartridges. See print cartridges
- input trays
 - features 7
 - included 4
 - jams, clearing 100
 - loading 28
 - locating 9
 - media supported 21
 - part numbers 123
 - selecting 33, 37
 - troubleshooting 78

- installing
 - memory 148
- interface ports
 - cables, ordering 122
 - connecting to 9
 - locating 9
 - troubleshooting 79, 84
 - types included 7
- Internet Explorer, versions supported 55

J

- jams
 - causes of 99
 - input areas 100
 - inside printer 99
 - output areas 102
- Jetadmin
 - operating systems supported 11
 - toner level, checking from 69
 - using 13
- Jetdirect print servers
 - information page, printing 52
 - part numbers 122
 - troubleshooting 76

K

- keys, control panel 23

L

- labels
 - output path 41
 - printing 43
 - specifications 20, 21
- language
 - information pages 52
- languages, printer
 - features 7
- laser safety statements 145
- LaserJet paper 124
- LaserWriter 8 driver 14
- letterhead
 - output path 41
 - printing 47
 - specifications 104
- life expectancies, supplies 68
- light print, troubleshooting 107
- lights
 - accessory error messages 98
 - consumables status messages 92
 - locating 23
 - printer status messages 95
 - printer status secondary messages 98
 - states 91
- Limit Check error 89
- lines, troubleshooting 108
- LINUX support 11

- loading media
 - tray 1 28
 - tray 2 29
 - tray 3 31
- loose toner, troubleshooting 110

M

- Macintosh
 - driver features 36
 - features supported 11
 - printing from 34
 - problems, troubleshooting 83
 - settings 36
 - software features 14
 - uninstalling software 15
- Magenta cartridge
 - empty or missing, light messages 93
 - life expectancy 68
 - low 92
 - non-HP 94
 - part number 120
 - status light 24, 92
 - See *also* cartridges
- mailing labels
 - output path 41
 - printing 43
 - specifications 20, 21
- maintenance
 - agreements 132, 143
 - replacing print cartridges 68
- Manual color options 64
- manual duplexing 48
- Manual Feed mode 79
- manuals 58, 127
- margins, envelopes 18
- matching, color 66
- Material Safety Data Sheet 143
- media
 - cardstock 46
 - custom-sized 37, 46
 - envelopes 18, 42
 - first page, different 40
 - glossy paper 45
 - HP, ordering 124
 - jams 99
 - labels 20, 43
 - letterhead 47
 - loading trays 28
 - long 28
 - output options 41
 - selecting 17
 - specifications 17
 - transparencies 20, 44
 - tray 1, types supported 21
 - troubleshooting 104

- memory
 - adding 148
 - DIMM slot errors 98
 - enabling 152
 - installing 149
 - part numbers 121
 - verifying installation 151
- mercury specifications 142
- messages
 - accessory errors 98
 - consumables status 92
 - Macintosh 89
 - printer status 95
 - secondary, printer status 98
- Microsoft Windows. *See* Windows
- models 4
- monitors, color matching 66
- multiple pages per sheet 39
- multipurpose paper, HP 124
- multipurpose tray. *See* tray 1

N

- N-up printing 39
- Netscape Navigator, versions supported 55
- networks
 - accessories, ordering 122
 - information pages, printing 52
 - software for 13
 - troubleshooting 76
- Neutral Grays options 65
- non-HP print cartridges 70
- not printing, troubleshooting 79

O

- on-site service agreements 132, 143
- on/off switch 9
- online customer support iii
- online Help
 - printer drivers 36
- operating environment, specifications 138
- operating systems supported 11
- optional tray 2. *See* tray 2
- optional tray 3. *See* tray 3
- options. *See* settings
- ordering supplies and accessories 120
- OS/2 support 11
- output bins
 - features 7
 - jams, clearing 102
 - locating 9
 - selecting 41
 - troubleshooting curl 80
- output quality
 - HP ImageREt 2400 62
 - settings 40
 - troubleshooting 105

- overhead transparencies
 - printing 44
 - specifications 20, 21
- ozone specifications 141

P

- packaging printer 134
- Page Setup 33
- page skew, troubleshooting 112
- pages per minute 6
- pages per sheet 39
- paper
 - cardstock 46
 - custom-sized 37, 46
 - first page, different 40
 - HP, ordering 124
 - jams 99
 - letterhead 47
 - loading trays 28
 - long 28
 - output options 41
 - selecting 17
 - specifications 17
 - tray 1, types supported 21
 - troubleshooting 104
- paper input trays
 - features 7
 - included 4
 - jams, clearing 100
 - loading 28
 - locating 9
 - media supported 21
 - part numbers 123
 - selecting 33, 37
 - troubleshooting 78
- paper output bins
 - features 7
 - jams, clearing 102
 - locating 9
 - selecting 41
 - troubleshooting curl 80
- parallel cables, ordering 122
- parallel port
 - connecting to 9
 - locating 9
 - type included 7
- parts
 - part numbers 120
 - user replaceable 126
- paused printing 25
- PCL drivers
 - backward compatibility 13
 - features 7
 - operating systems supported 11
 - settings 36
- PDEs, Macintosh 14

- personalities
 - features 7
- phone numbers
 - HP fraud hotline 70
 - HP Printing Supplies Returns and Recycling Program 142
 - support iii
- pick-up rollers, ordering 126
- platforms supported 11
- ports
 - cables, ordering 122
 - connecting to 9
 - locating 9
 - troubleshooting 79, 84
 - types included 7
- PostScript
 - driver settings 36
 - errors 82
 - features 7
 - operating systems supported 11
- power
 - consumption 141
 - requirements 138
 - switch 9
 - troubleshooting 74
- PPDs, Macintosh 14
- preprinted paper
 - output path 41
 - printing on 47
 - specifications 104
- print cartridges
 - empty or missing, light messages 93
 - HP fraud hotline 70
 - life expectancy 68
 - low 92
 - non-HP 94
 - part numbers 120
 - recycling 141
 - replacing 69
 - status lights 24, 92
 - status page, printing 53
 - storage specifications 138
- Print dialog box 33
- print media. *See* media
- print quality
 - HP ImageREt 2400 62
 - settings 40
 - specifications 6
 - troubleshooting 105
- print servers
 - information page, printing 52
 - part numbers 122
 - troubleshooting 76
- printer drivers
 - downloading 12
 - features 36
 - Macintosh 14
 - opening 33
 - operating systems supported 11
 - restoring default settings 40
 - settings, changing 35
 - uninstalling 14
 - Windows, features 13
- printer languages
 - features 7
- printing
 - both sides 48
 - canceling 50
 - Macintosh 34
 - troubleshooting 79
 - Windows 34
- problem solving. *See* troubleshooting
- processing message 96
- programs, settings 12
- properties. *See* settings
- PS
 - driver settings 36
 - errors 82
 - features 7
 - operating systems supported 11

Q

- quality
 - HP ImageREt 2400 62
 - settings 40
 - specifications 6
 - troubleshooting 105
- Quick Sets 39

R

- Readme 58
- Ready light 25, 96, 119
 - See also* lights
- rear output door
 - features 7
 - locating 9
 - printing to 41
- recycling
 - plastics 141
 - print cartridges 141
- reducing documents 39
- refilled print cartridges 70
- refilling paper 28
- regulatory statements
 - declaration of conformity 144
 - FCC 140
 - laser safety 145
 - Material Safety Data Sheet 143
- repacking printer 134
- repair. *See* service
- repetitive defects, troubleshooting 110, 114
- replacement parts. *See* supplies\service
- replacing print cartridges 69
- reports, printing 52

- resizing documents 39
- resolution
 - HP ImageREt 2400 62
 - settings 40
 - specifications 6
 - troubleshooting print quality 105
- restoring default settings 40
- resuming printing 25
- RGB color options 65, 66
- rollers, ordering 126
- Rotate Carousel button 24

- S**
- saving settings 39
- scaling documents 39
- scanners, color matching 66
- scatter, troubleshooting 113
- screen color matching 66
- secondary messages
 - accessory errors 98
 - printer status lights 98
- separation pad, ordering 126
- servers
 - information page, printing 52
 - part numbers 122
 - troubleshooting 76
- service
 - agreements 132, 143
 - errors 97
 - HP Express Exchange 133
 - information form 136
 - part numbers 120
 - repacking printer 134
- settings
 - changing 12, 35
 - color 64
 - restoring defaults 40
 - saving 39
- shipping printer 134
- size, printer 137
- sizes, media
 - custom 37, 46
 - selecting trays 33
- skew, troubleshooting 112
- slanted pages 112
- slow printing, troubleshooting 77
- smearred toner, troubleshooting 109
- Smooth halftone option 64
- software
 - downloading 12
 - features 36
 - Macintosh, features 14
 - operating systems supported 11
 - settings, changing 35
 - Toolbox 55
 - uninstalling 14
 - Windows, features 13
- source, printing by 33, 37
- spare parts. See supplies\service
- special media
 - cardstock 46
 - custom-sized 37, 46
 - envelopes 18, 42
 - glossy paper 45
 - labels 20, 43
 - letterhead 47, 104
 - output path 41
 - specifications 21
 - transparencies 20, 44
- specifications
 - envelopes 18
 - environmental 138
 - labels 20
 - Material Safety Data Sheet 143
 - paper 17
 - printer 137
 - printer features 6
 - transparencies 20
 - trays, media supported 21
- specks, troubleshooting 107
- speed
 - maximizing 35
 - specifications 6
 - troubleshooting 77
- spots, troubleshooting 107
- sRGB 65, 66
- status
 - lights. See lights
 - Supplies Status page, printing 53
 - viewing with HP Toolbox 56
- Status tab, HP Toolbox 56
- stopping printing 50
- storing
 - envelopes 19
 - paper 18
 - print cartridges 69
 - printer 138
- straight-through paper path 41
- streaks, troubleshooting 108
- supplies
 - availability 143
 - life expectancies 68
 - recycling 141
 - specifications 137
 - status lights 24, 92
 - status page 53
- support
 - HP Express Exchange 133
 - maintenance agreements 132, 143
 - part numbers 120
 - repacking printer 134
 - service information form 136
- SupportPack, HP 132, 143

- T**
- technical support
 - HP Express Exchange 133
 - maintenance agreements 132, 143
 - part numbers 120
 - repacking printer 134
 - service information form 136
 - telephone numbers
 - HP fraud hotline 70
 - HP Printing Supplies Returns and Recycling Program 142
 - support iii
 - temperature specifications
 - paper, storing 18
 - printer environment 138
 - text, troubleshooting 80, 111
 - toner
 - low 92
 - out 93
 - scatter, troubleshooting 113
 - smeared, troubleshooting 109
 - specks, troubleshooting 107
 - status lights 24
 - toner cartridges. *See* print cartridges
 - Toolbox
 - operating systems supported 11
 - using 55
 - top cover, locating 9
 - top output bin
 - features 7
 - locating 9
 - printing to 41
 - troubleshooting curl 80
 - transparencies
 - printing 44
 - specifications 20, 21
 - Trapping options 65
 - tray 1
 - loading 28
 - locating 9
 - maximizing print speed 35
 - See also* trays
 - tray 2
 - loading 29
 - locating 9
 - part number 123
 - size specifications 137
 - troubleshooting 78
 - See also* trays
 - tray 3
 - loading 31
 - locating 9
 - part number 123
 - size specifications 137
 - troubleshooting 78
 - See also* trays
 - trays
 - features 7
 - included 4
 - jams, clearing 100
 - loading 28
 - locating 9
 - media supported 21
 - part numbers 123
 - selecting 33, 37
 - troubleshooting 78
 - troubleshooting
 - accessory errors 98
 - blank pages 80
 - calibrating printer 72
 - checklist 74
 - color 114
 - Configuration page, printing 52
 - consumables status messages 92
 - control panel messages 91
 - curl 80, 112
 - Demo page, printing 52
 - EPS files 84
 - faded print 107
 - fonts 82, 84
 - jams 99
 - Limit Check errors 89
 - lines 108
 - Macintosh problems 83
 - media 104
 - PostScript (PS) errors 82
 - print-quality problems 105
 - printer status messages 95
 - printing 79
 - repetitive defects 110, 114
 - replacing print cartridges 69
 - secondary printer status messages 98
 - skewed pages 112
 - slow printing 77
 - text 80
 - toner smear 107
 - trays 78
 - wrinkles 113
 - Troubleshooting tab, HP Toolbox 56
 - TrueType fonts, included 7, 119
 - See also* fonts
 - two-sided printing 48
 - typefaces. *See* fonts
 - types, media
 - selecting trays by 33, 37
- U**
- uninstalling software 14
 - UNIX support 11
 - upgrading memory 148
 - USB cables, ordering 122

- USB port
 - connecting to 9
 - locating 9
 - troubleshooting 84
 - type included 7
- user guide
 - accessing 58
 - part numbers 127
- user replaceable parts 126

V

- vertical lines, troubleshooting 108
- voltage requirements 138

W

- warranty
 - extended 132, 143
 - print cartridge 131
 - product 129
- watermarks 38
- wave, troubleshooting 80, 112
- Web browser requirements 55
- Web Jetadmin
 - operating systems supported 11
 - toner level, checking from 69
 - using 13
- websites
 - customer support iii
 - HP Printing Supplies Returns and Recycling Program 142
 - HP Web Jetadmin 13
 - Material Safety Data Sheet 143
- weight
 - printer 137
- Windows
 - driver features 36
 - driver Help 36
 - printing from 34
 - settings 35
 - uninstalling software 14
 - versions supported 11
- wrinkles, troubleshooting 113

Y

- Yellow cartridge
 - empty or missing, light messages 93
 - life expectancy 68
 - low 92
 - non-HP 95
 - part number 120
 - status light 24, 92
 - See *a/so* cartridges



i n v e n t

© 2004 Hewlett-Packard Development Company, LP

www.hp.com/support/clj2550



Q3702-90952