

hp color LaserJet
2550 printer

service

hp color LaserJet 2550 series printer

Service Manual _____

Copyright information

© 2004 Copyright Hewlett-Packard Development Company, L.P.

Reproduction, adaptation, or translation without prior written permission is prohibited, except as allowed under the copyright laws.

The information contained herein is subject to change without notice.

The only warranties for HP products and services are set forth in the express warranty statements accompanying such products and services. Nothing herein should be construed as constituting an additional warranty. HP shall not be liable for technical or editorial errors or omissions contained herein.

Part number Q3702-90923

Edition 1, 5/2004

Safety information

WARNING!

Potential Shock Hazard

Always follow basic safety precautions when using this product to reduce risk of injury from fire or electric shock.

Read and understand all instructions in the user guide.

Observe all warnings and instructions marked on the product.

Use only a grounded electrical outlet when connecting the printer to a power source. If you do not know whether the outlet is grounded, check with a qualified electrician.

Do not touch the contacts on the end of any of the sockets on the printer. Replace damaged cords immediately.

Unplug this product from wall outlets before cleaning.

Do not install or use this product near water or when you are wet.

Install the product securely on a stable surface.

Install the product in a protected location where no one can step on or trip over the power cord and where the power cord will not be damaged.

If the product does not operate normally, see the online user guide.

Refer all servicing questions to qualified personnel.

Information regarding FCC Class B, Parts 15 and 68 requirements can be found in the user guide.

Trademark credits

Adobe®, Acrobat®, Adobe® PostScript® 3™, and the Acrobat Logo® are trademarks of Adobe Systems Incorporated.

Microsoft®, Windows®, and Windows NT® are U.S. registered trademarks of Microsoft Corporation.

UNIX® is a registered trademark of The Open Group.

Energy Star® and the Energy Star logo® are U.S. registered marks of the United States Environmental Protection Agency.



Table of contents

1 Product information

Chapter contents	1
Printer configurations	2
HP color LaserJet 2550L	2
HP color LaserJet 2550Ln	2
HP color LaserJet 2550n	3
Printer features	4
Printer overview.....	7
Hardware components.....	7
Model and serial numbers	7
Software components	9
Software and supported operating systems	9
Software tips	10
Software for Windows	11
Software for Macintosh	12
Uninstalling the printing software	13
Specifications	15
Media specifications	17
Supported media weights and sizes	17
General guidelines	18
Paper and print media	19
Printing and storage environment	19
Envelopes	20
Labels	21
Transparencies	22
Hewlett-Packard limited warranty statement	23
Limited warranty for the print cartridges and imaging drum	24
Print cartridge information	25
Refilled print cartridges	25
HP LaserJet printing supplies	25
HP Printing Supplies Returns and Recycling Program information.....	25
Regulatory statements	27
Safety statements	28
Laser safety statement	28
Canadian DOC statement	28
Korean EMI statement	28
Finnish laser statement	29

2 Installation and operation

Chapter contents	31
Operating environment	32
Interface ports	33
Control panel features	34
Understanding Supplies Status	34
Understanding Printer Status	35

Input trays	37
Printer output paths	38
Top output bin	38
Rear output door	38
Loading media	39
Loading tray 1	39
Loading optional tray 2	40
Loading optional tray 3	42
HP LaserJet Toolbox	44
Supported operating systems	44
Supported browsers	44
Viewing the HP LaserJet Toolbox	45
Status tab	45
Troubleshooting tab	45
Alerts tab	46
Documentation tab	46
Device Settings window	47
Other links	48

3 Maintenance

Chapter contents	49
Life expectancies of supplies	50
User-replaceable parts	52
Replacing the tray 1 pickup roller and separation pad	52
Replacing the separation pad in optional tray 2 or in optional tray 3	57
Cleaning the printer	61
Cleaning the printer	61
Calibrating the printer	63
To calibrate the printer at the printer	63
To calibrate the printer from the HP LaserJet Toolbox	63
Managing supplies	64
Supplies life	64
Checking and ordering supplies	64
Storing supplies	65
Replacing and recycling supplies	65
HP policy for non-HP supplies	66
HP fraud hotline	66

4 Theory of operation

Chapter contents	67
Introduction	68
Engine control system	70
Basic sequence of operation	70
Power-on sequence	72
Motors and fans	73
Laser/scanner system	74
Pickup and feed system	75
Paper trays	76
Jam detection	77
Photosensors and switches	78
Solenoid and clutches	80
Printed circuit assemblies	82
Image-formation system	84
Image-formation process	85
Latent-image-formation stage	85

Developing stage	86
Transfer stage	87
Fusing stage	89
Print cartridge	93
Imaging-drum E-label	94

5 Removal and replacement

Chapter contents	97
Introduction	99
Removal and replacement strategy	99
Electrostatic discharge	99
User-replaceable parts	99
Required tools	99
Before performing service	101
Pre-service procedures	101
Parts removal order	102
Removal and replacement	103
Imaging drum	103
Print cartridges	103
Fuser cover (and fuser)	104
Right- and left-side covers	106
Control panel	107
On-off switch	109
Interface cover	110
Formatter assemblies	111
Fuser motor	116
Dc controller	117
Optional tray 2 (250-sheet tray)	118
Carousel-engagement motor	120
Front lower cover	121
Back cover	122
Top cover	123
Top door	125
Air duct and fan	127
Laser/scanner assembly	128
Front cover	130
Density sensor and top-of-page sensor	130
E-label reader (for imaging-drum E-labels)	132
Tray 1 (multipurpose tray)	133
Tray 1 separation pad assembly	135
Gear assembly	136
Waste-toner sensor	138
Rotary-drive assembly	139
Top plate	142
Print-cartridge carousel	145
Aligning the carousel gears	149
Registration-roller assembly	150
Toner-catch tray	151
Transfer-roller plate	152
Transfer roller	152
Feed-drive shaft	153
ECU pan	154
Sub-high-voltage transformer PCA	157
High-voltage transformer PCA	158
Low-voltage PCA	159

Paper-top sensor	160
Fuser-wrap sensor	161
250-sheet feeder pickup roller	162
500-sheet feeder pickup roller	163

6 Troubleshooting

Chapter contents.....	167
Basic troubleshooting	169
Clearing jams	171
Where to look for jams	171
To clear jams from inside the printer	171
To clear jams from input areas	172
To clear jams from output areas	174
Control panel light messages	176
Supplies Status lights	177
Printer Status lights	182
Solving image-quality problems	190
Print-quality checklist	190
Solving image-quality problems (all print jobs)	190
Solving image-quality problems (color print jobs)	200
Resolving problems that generated messages	204
Messages for both Windows and Macintosh	204
Messages for Windows only	204
Resolving problems that did not generate messages	206
Troubleshooting checklist	206
Checking the network	207
Solving general printing problems	207
Solving PostScript (PS) errors	212
Solving common Macintosh problems	213
Manually rotating the print-cartridge carousel	216
Functional checks	218
Engine test	218
High-voltage power-supply check	219
Paper-path check	219
Service mode functions	221
Cold reset	221
NVRAM initializer	221
Error report.....	222
Super NVRAM initialization.....	222
Network card cold reset.....	222
Using PJI commands	223
Troubleshooting tools	225
Demo page	225
Configuration page	225
Supplies Status page	226
Repetitive image defects	227
General timing charts	228
Locations of connectors	230
Dc controller connections	233
Main wiring diagram	234
HP LaserJet Toolbox	236
To view the HP LaserJet Toolbox	236

7 Parts and diagrams

Chapter contents	237
------------------------	-----

Ordering parts and supplies	238
Parts	238
Related documentation and software	238
Supplies	238
Accessories	239
Assembly locations (1 of 2).....	241
Assembly locations (2 of 2).....	242
Covers.....	244
Internal assemblies.....	246
PCA assemblies.....	268
Alphabetical parts list.....	270
Numerical parts list.....	278

Index

List of tables

Table 1-1.	HP color LaserJet 2550 series printer software	9
Table 1-2.	Physical specifications	15
Table 1-3.	Supplies specifications	15
Table 1-4.	Electrical specifications	15
Table 1-5.	Environmental specifications	16
Table 1-6.	Acoustic emissions (HP color LaserJet 2550 series)	16
Table 1-7.	Tray 1 specifications	17
Table 1-8.	Optional tray 2 specifications	18
Table 1-9.	Optional tray 3 specifications	18
Table 2-1.	Input tray configuration	37
Table 3-1.	Life expectancies of supplies	51
Table 4-1.	Basic sequence of operation	70
Table 4-2.	Motors and fans.....	73
Table 4-3.	Photosensors and switches.....	79
Table 4-4.	Solenoid.....	80
Table 4-5.	Clutches.....	81
Table 4-6.	Printed circuit assemblies.....	83
Table 6-1.	Basic troubleshooting	169
Table 6-2.	Control panel lights legend	176
Table 6-3.	Supplies Status light messages	177
Table 6-4.	Printer-status light messages	182
Table 6-5.	Attention light messages, unnumbered.....	184
Table 6-6.	Attention light messages, numbered.....	185
Table 6-7.	Accessory error light messages.....	186
Table 6-8.	Service error light messages.....	186
Table 6-9.	Additional error messages.....	189
Table 6-10.	Solving general printing problems	207
Table 6-11.	Problems in the Chooser	213
Table 6-12.	Printing Errors	214
Table 6-13.	USB Problems	215
Table 6-14.	Repetitive image defects.....	227
Table 7-1.	Technical support Web sites	238
Table 7-2.	Accessories	239
Table 7-3.	Covers	245
Table 7-4.	Front frame assembly	247
Table 7-5.	Internal components (1 of 2)	251
Table 7-6.	Internal components (2 of 2)	253
Table 7-7.	Main drive assembly.....	255
Table 7-8.	Rear frame assembly	257
Table 7-9.	Middle frame assembly	259
Table 7-10.	Rotary assembly	263
Table 7-11.	Power-supply base assembly	265
Table 7-12.	Rotary-drive assembly	267
Table 7-13.	PCA assemblies	269
Table 7-14.	Alphabetical parts list.....	270
Table 7-15.	Numerical parts list.....	278

List of figures

Figure 1-1.	HP color LaserJet 2550 series printer identification label	8
Figure 2-1.	Space required	32
Figure 2-2.	Standard and optional input trays—HP color LaserJet 2550 series printers	37
Figure 2-3.	Printer output paths	38
Figure 3-1.	Smearing.....	61
Figure 3-2.	Toner specks	61
Figure 3-3.	Loading the cleaning page in tray 1	62
Figure 4-1.	Cross-section of the printer	68
Figure 4-2.	Engine control system (includes the basic configuration of the printer)	70
Figure 4-3.	Power-on sequence	72
Figure 4-4.	Motors and fans.....	73
Figure 4-5.	Laser/scanner system	74
Figure 4-6.	Pickup and feed system	76
Figure 4-7.	Optional tray 2 (250-sheet paper tray)	77
Figure 4-8.	Photosensors and switches (1 of 2)	78
Figure 4-9.	Photosensors and switches (2 of 2).....	79
Figure 4-10.	Solenoid	80
Figure 4-11.	Clutches	81
Figure 4-12.	Printed circuit assemblies (1 of 2)	82
Figure 4-13.	Printed circuit assemblies (2 of 2)	83
Figure 4-14.	Image-formation system	84
Figure 4-15.	Image-formation process	85
Figure 4-16.	Step 1: primary charging	86
Figure 4-17.	Step 2: laser-beam exposure	86
Figure 4-18.	Developing block	87
Figure 4-19.	Step 3: developing	87
Figure 4-20.	Step 4: primary transfer	88
Figure 4-21.	Step 5: secondary transfer	89
Figure 4-22.	Step 6: separation	89
Figure 4-23.	Step 7: fusing	90
Figure 4-24.	Step 8: roller charging (auxiliary transfer belt cleaning roller)	90
Figure 4-25.	Step 9: roller charging (transfer belt cleaning roller)	91
Figure 4-26.	Step 10: transfer belt cleaning	92
Figure 4-27.	Step 11: drum cleaning	93
Figure 4-28.	Print cartridge	94
Figure 4-29.	Print-cartridge E-label	95
Figure 5-1.	Removing the fuser cover (and fuser)	105
Figure 5-2.	Removing the right-side cover (1 of 2)	106
Figure 5-3.	Removing the right-side cover (2 of 2)	107
Figure 5-4.	Removing the control panel (1 of 2)	108
Figure 5-5.	Removing the control panel (2 of 2)	109
Figure 5-6.	Removing the on-off switch	110
Figure 5-7.	Removing the interface cover	111
Figure 5-8.	Removing the formatter cage (1 of 2)	112
Figure 5-9.	Removing the formatter cage (2 of 2)	113

Figure 5-10.	Removing the formatter (1 of 2)	114
Figure 5-11.	Removing the formatter (2 of 2)	115
Figure 5-12.	Removing the network card	116
Figure 5-13.	Removing the fuser motor	117
Figure 5-14.	Removing the dc controller	118
Figure 5-15.	Removing optional tray 2 (1 of 2)	119
Figure 5-16.	Removing optional tray 2 (2 of 2)	120
Figure 5-17.	Removing the carousel-engagement motor	121
Figure 5-18.	Removing the front lower cover	122
Figure 5-19.	Removing the back cover	123
Figure 5-20.	Removing the top cover (1 of 2)	124
Figure 5-21.	Removing the top cover (2 of 2)	125
Figure 5-22.	Removing the top door (1 of 2)	126
Figure 5-23.	Removing the top door (2 of 2)	127
Figure 5-24.	Removing the air duct	128
Figure 5-25.	Removing the laser/scanner assembly	129
Figure 5-26.	Reinstalling the top output bin cover	129
Figure 5-27.	Removing the front cover	130
Figure 5-28.	Removing the density sensor cover	131
Figure 5-29.	Removing the density sensor	131
Figure 5-30.	Removing the E-label reader (1 of 2)	132
Figure 5-31.	Removing the E-label reader (2 of 2)	133
Figure 5-32.	Removing tray 1 (1 of 2)	134
Figure 5-33.	Removing tray 1 (2 of 2)	135
Figure 5-34.	Removing the tray 1 separation pad assembly	136
Figure 5-35.	Removing the gear assembly (1 of 2)	137
Figure 5-36.	Removing the gear assembly (2 of 2)	138
Figure 5-37.	Removing the waste-toner sensor	139
Figure 5-38.	Removing the rotary-drive assembly (1 of 3)	140
Figure 5-39.	Removing the rotary-drive assembly (2 of 3)	141
Figure 5-40.	Removing the rotary-drive assembly (3 of 3)	142
Figure 5-41.	Removing the top plate (1 of 3)	143
Figure 5-42.	Removing the top plate (2 of 3)	144
Figure 5-43.	Reinstalling the grounding plate	144
Figure 5-44.	Removing the top plate (3 of 3)	145
Figure 5-45.	Removing the print-cartridge carousel (1 of 3)	146
Figure 5-46.	Removing the print-cartridge carousel (2 of 3)	147
Figure 5-47.	Removing the print-cartridge carousel (3 of 3)	148
Figure 5-48.	Reinstalling the print-cartridge carousel	150
Figure 5-49.	Removing the registration-roller assembly	151
Figure 5-50.	Removing the toner-catch tray	151
Figure 5-51.	Removing the transfer-roller plate	152
Figure 5-52.	Removing the transfer roller	153
Figure 5-53.	Removing the feed-drive shaft	154
Figure 5-54.	Removing the ECU pan (1 of 2)	155
Figure 5-55.	Removing the ECU pan (2 of 2)	156
Figure 5-56.	ECU connections	156
Figure 5-57.	Removing the sub-high-voltage transformer PCA	157
Figure 5-58.	Removing the high-voltage transformer PCA	158
Figure 5-59.	Removing the low-voltage PCA (1 of 2)	159
Figure 5-60.	Removing the low-voltage PCA (2 of 2)	160
Figure 5-61.	Removing the paper-top sensor	161
Figure 5-62.	Removing the fuser wrap sensor	162
Figure 5-63.	Removing the 250-sheet feeder pickup roller	163
Figure 5-64.	Removing the 500-sheet feeder pickup roller (1 of 2)	164
Figure 5-65.	Removing the 500-sheet feeder pickup roller (2 of 2)	165

Figure 6-1.	Control panel lights	176
Figure 6-2.	Manually rotating the print-cartridge carousel	217
Figure 6-3.	Location of the engine-test switch	218
Figure 6-4.	Print cartridge high-voltage connection points	219
Figure 6-5.	Overriding SW301 and the laser/scanner switch	220
Figure 6-6.	General timing chart--WAIT period	228
Figure 6-7.	General timing chart--one page, full-color, normal speed	229
Figure 6-8.	Locations of printer connectors (1 of 3)	230
Figure 6-9.	Locations of printer connectors (2 of 3)	231
Figure 6-10.	Locations of printer connectors (3 of 3)	231
Figure 6-11.	Locations of 250-sheet tray connectors	232
Figure 6-12.	Locations of 500-sheet tray connectors	232
Figure 6-13.	Dc controller connections	233
Figure 6-14.	Main wiring (1 of 2)	234
Figure 6-15.	Main wiring (2 of 2)	235
Figure 7-1.	Covers.....	244
Figure 7-2.	Front frame assembly	246
Figure 7-3.	Internal components (1 of 2).....	250
Figure 7-4.	Internal components (2 of 2)	252
Figure 7-5.	Main drive assembly	254
Figure 7-6.	Rear frame assembly	256
Figure 7-7.	Middle frame assembly	258
Figure 7-8.	Rotary (carousel) assembly	262
Figure 7-9.	Power-supply base assembly	264
Figure 7-10.	Rotary-drive assembly	266
Figure 7-11.	PCA assemblies	268

1

Product information

Chapter contents

Chapter contents	1
Printer configurations	2
HP color LaserJet 2550L	2
HP color LaserJet 2550Ln	2
HP color LaserJet 2550n	3
Printer features	4
Printer overview.....	7
Hardware components.....	7
Model and serial numbers	7
Software components	9
Software and supported operating systems	9
Software tips	10
Software for Windows	11
Software for Macintosh	12
Uninstalling the printing software	13
Specifications	15
Media specifications	17
Supported media weights and sizes	17
General guidelines	18
Paper and print media	19
Printing and storage environment	19
Envelopes	20
Labels	21
Transparencies	22
Hewlett-Packard limited warranty statement	23
Limited warranty for the print cartridges and imaging drum	24
Print cartridge information	25
Refilled print cartridges	25
HP LaserJet printing supplies	25
HP Printing Supplies Returns and Recycling Program information.....	25
Regulatory statements	27
Safety statements	28
Laser safety statement	28
Canadian DOC statement	28
Korean EMI statement	28
Finnish laser statement	29

Printer configurations

Thank you for purchasing the HP color LaserJet 2550 series printer. The printer is available in the following configurations.

HP color LaserJet 2550L

The HP color LaserJet 2550L printer is a four-color laser printer that prints letter-size pages up to 20 pages per minute (ppm) in black and white, A4-size pages up to 19 ppm, and it prints letter/A4-size pages at 4 ppm in color. It includes a PCL 6 printer driver and has PostScript® level 3 emulation.



- **Trays.** The printer comes with a multipurpose tray (tray 1) that holds up to 125 sheets of various print media or 10 envelopes. The printer can also accept an optional 250-sheet tray (tray 2) for standard sizes and optional 500-sheet tray (tray 3) for A4 and letter sizes. (Optional tray 2 must be installed in order to install optional tray 3.) See [Supported media weights and sizes](#) for more information.
- **Print cartridges.** This model comes standard with color print cartridges (cyan, yellow, and magenta) that can print up to 2,000 pages at 5 percent coverage. It comes with a black print cartridge that can print up to 5,000 pages at 5 percent coverage. (A typical business letter has 5 percent coverage.)
- **Connectivity.** The printer provides parallel and universal serial bus (USB) ports for connectivity. The printer also accepts an optional HP Jetdirect external print server for connecting to a network.
- **Memory.** The printer comes standard with 64 MB RAM.
- **Expandability.** The printer has one available DIMM slot for memory expansion and additional font support. The memory is expandable to 192 MB by adding a 128-MB DIMM.

HP color LaserJet 2550Ln

The HP color LaserJet 2550Ln printer has the same features as the HP color LaserJet 2550L printer, except it *includes* an HP Jetdirect internal print server for connecting to a 10/100Base-T network. This model also accepts optional tray 2 and optional tray 3. (Optional tray 2 must be installed in order to install optional tray 3.)



HP color LaserJet 2550n

The HP color LaserJet 2550n printer has the same features as the HP color LaserJet 2550Ln printer and also includes tray 2. This model also accepts optional tray 3. This model comes standard with high-capacity color print cartridges that can print up to 4,000 pages.



Printer features

Feature	HP color LaserJet 2550 series printer
Color printing	<ul style="list-style-type: none"> ● Provides laser printing in full color by using the four process colors: cyan, magenta, yellow, and black (CMYK).
Fast print speed	<ul style="list-style-type: none"> ● Prints in black on letter-size paper up to 20 ppm and on A4-size paper up to 19 ppm. Prints in color on A4/letter at 4 ppm.
Excellent print quality	<ul style="list-style-type: none"> ● ImageREt 2400 provides 2400 dpi (dots per inch) color and laser-class quality through a multilevel printing process. ● True 600 x 600 dpi text and graphics. ● Adjustable settings to optimize print quality. ● The HP UltraPrecise print cartridge has a finer toner formulation that provides sharper text and graphics.
Ease of use	<ul style="list-style-type: none"> ● Few supplies to order. Supplies are easy to install. ● Convenient access to printer information and settings by using the HP LaserJet Toolbox software. ● Convenient access to all supplies and to the paper path through the front door.
Expandability	<ul style="list-style-type: none"> ● Optional tray 2. (Included with the 2550n model; compatible with all other models.) This 250-sheet tray for standard sizes reduces how often you have to add paper to the printer. Only one 250-sheet tray can be installed on the printer. ● Optional tray 3. This 500-sheet tray for letter and A4 sizes reduces how often you have to add paper to the printer. Only one 500-sheet tray can be installed on the printer. Optional tray 2 must be installed in order to install optional tray 3. ● Optional HP Jetdirect external print server for connecting to a network (HP color LaserJet 2550L printer). ● One DIMM slot for adding memory and fonts.

Feature	HP color LaserJet 2550 series printer
Flexible paper handling	<ul style="list-style-type: none"> ● Adjustable tray 1 (multipurpose tray) for letterhead, envelopes, labels, transparencies, custom-sized media, postcards, glossy paper, HP LaserJet Tough paper, and heavy paper. ● Optional tray 2 (250-sheet tray) that is adjustable for several standard sizes of paper. ● Optional tray 3 (500-sheet tray) for letter- and A4-size paper. (Optional tray 2 must be installed in order to install optional tray 3.) ● One 125-sheet output bin and one output door. Select the top output bin (face down) for most jobs, including transparencies. Use the rear output door (face up) for jobs on heavy paper, light paper, or special print media. ● Straight-through paper path capability from tray 1 to the rear output door. ● Manual two-sided printing (duplexing). See Interface cover.
Printer driver features	<ul style="list-style-type: none"> ● Fast printing performance, built-in Intellifont and TrueType scaling technologies, built-in HP-GL/2 vector graphics, and advanced imaging capabilities are benefits of the PCL 6 printer language. The PCL 6 also includes 45 scalable TrueType fonts and one bitmapped Line Printer Font. The PCL 6 printer language also included.
PostScript® (PS) level 3 emulation language and fonts	<ul style="list-style-type: none"> ● Includes 35 built-in PS language fonts.
Automatic language-switching	<ul style="list-style-type: none"> ● The printer automatically determines and switches to the appropriate printer language (such as PS or PCL 6) for the print job.
Interface connections	<ul style="list-style-type: none"> ● Bidirectional enhanced capabilities port (ECP) type-B parallel port (IEEE-1284 compliant). ● High-speed USB port. ● Accepts an optional HP Jetdirect external print server (HP color LaserJet 2550L printer). The HP color LaserJet 2550Ln and 2550n printers include an HP Jetdirect internal print server.

Feature	HP color LaserJet 2550 series printer
Networking	<ul style="list-style-type: none"> ● Accepts an optional HP Jetdirect external print server (HP color LaserJet 2550L printer). The HP color LaserJet 2550Ln and 2550n printers include an HP Jetdirect internal print server. ● All common network protocols such as Ethernet, Token Ring, and LocalTalk are available by using an optional HP Jetdirect external print server. (The 2550Ln and 2550n models include an HP Jetdirect internal print server.)
Enhanced memory and memory expansion	<ul style="list-style-type: none"> ● The printer comes with 64 MB of memory and can be expanded to 192 MB by using the DIMM slot. Most documents can be printed with the standard amount of printer memory through the aid of Memory Enhancement technology (MEt). MEt automatically compresses data, and almost doubles the printer memory and accommodating more complex printing with available memory.
Energy savings	<ul style="list-style-type: none"> ● The printer automatically conserves electricity by substantially reducing power consumption when it is not printing. ● As an ENERGY STAR® partner, Hewlett-Packard Company has determined that this product meets ENERGY STAR® guidelines for energy efficiency. ENERGY STAR® is a U.S. registered service mark of the United States Environmental Protection Agency.
Economical printing	<ul style="list-style-type: none"> ● N-up printing (printing more than one page on a sheet) and two-sided printing using manual duplexing saves paper. See To use a cleaning page and Interface cover.
Supplies	<ul style="list-style-type: none"> ● A Supplies Status page with print cartridge and imaging drum gauges that show the supply levels that remain. For HP supplies only. ● No-shake cartridge design. ● Authentication for HP print cartridges. ● Enabled supplies-ordering capability.
Accessibility	<ul style="list-style-type: none"> ● Online user guide that is compatible with text screen-readers. ● Print cartridges and the imaging drum can be installed and removed by using one hand. ● All doors and covers can be opened by using one hand.

Printer overview

Hardware components

Before using the printer, familiarize yourself with the parts of the printer.

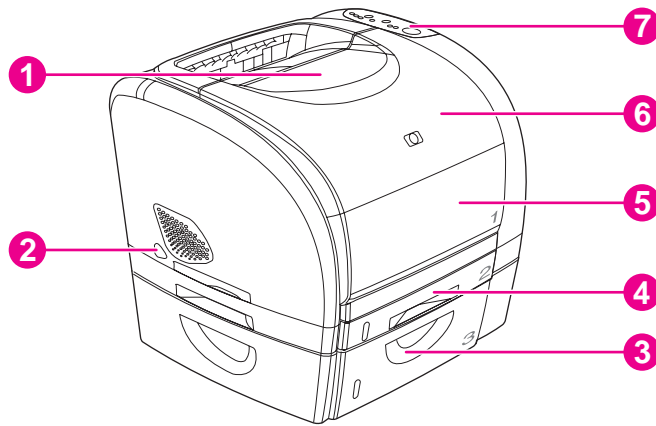

- 1 Top (face-down) output bin
- 2 Power switch
- 3 Optional tray 3
- 4 Optional tray 2 (included with HP color LaserJet 2550n model)
- 5 Tray 1
- 6 Top cover
- 7 Control panel

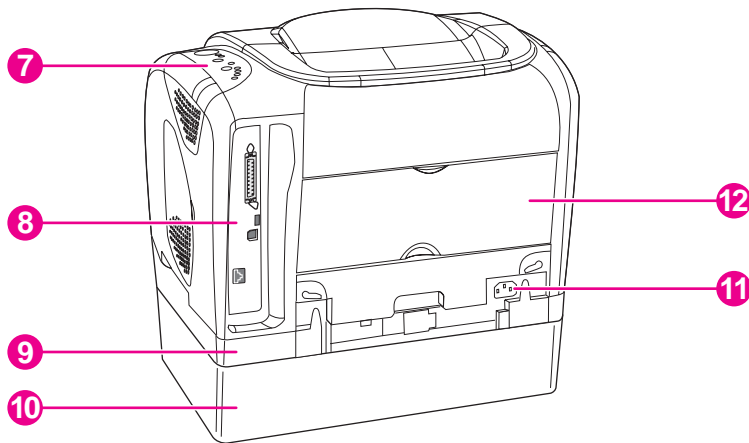

- 7 Control panel
- 8 Interface ports *
- 9 Optional tray 2
- 10 Optional tray 3
- 11 Power connector
- 12 Rear (face-up) output door

* The interface ports are described in more detail in the next chapter. See [Interface ports](#).

Model and serial numbers

The model number and serial number are listed on an identification label located underneath the top door.

The label contains information about the country/region of origin and the revision level, manufacturing date, production code, and production number of the product. The label also contains power rating and regulatory information.

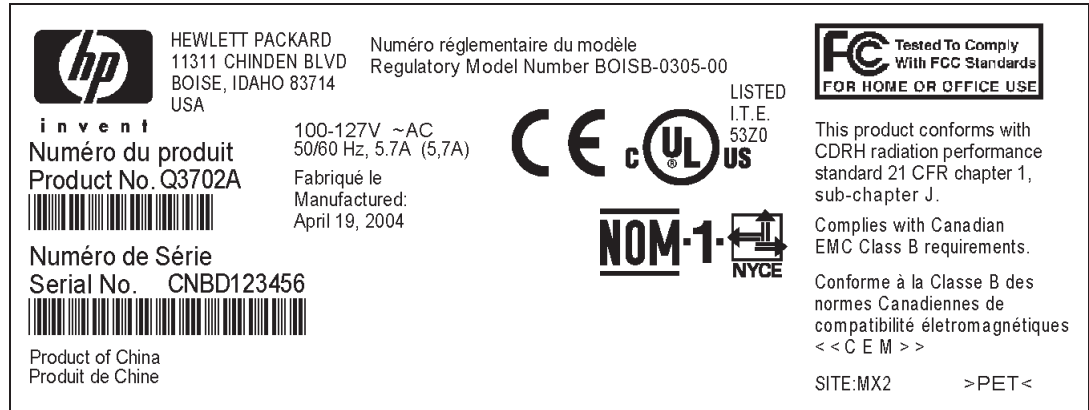

Figure 1-1.

HP color LaserJet 2550 series printer identification label

Software components

Software and supported operating systems

For easy printer setup and access to the full range of printer features, HP strongly recommends that you install the software that is provided. Not all software is available in all languages. See the *HP Color LaserJet 2550 Series Printer Getting Started Guide* for installation instructions, and see the Readme file for the latest software information.

The most recent drivers, additional drivers, and other software are available from the Internet and other sources. See [Related documentation and software](#).

The printer supports the following operating systems:

- Microsoft® Windows® 98, Windows 2000, Windows Millennium Edition (Me), and Windows XP
- Windows NT® 4.0 (driver only, other printer software is not available)
- Macintosh OS 9.1, 9.2, 9.3, and OS X v.10.1 and later
- UNIX®, Linux, and OS/2 (limited functionality)

The following tables list the software that is available for your operating system.

Table 1-1. HP color LaserJet 2550 series printer software

Feature	Windows 98, Me	Windows 2000 and XP	Macintosh OS 9.1, 9.2, and 9.3	Macintosh OS X v. 10.1 and later	UNIX®, Linux	OS/2
Windows Installer	✓	✓				
PCL 6 printer driver	✓	✓				
PS printer driver	✓	✓				
HP Web Jetadmin software		✓ ₁				
HP HP LaserJet Toolbox software	✓	✓		✓ ₂		
Macintosh Installer			✓	✓		

Table 1-1. HP color LaserJet 2550 series printer software (continued)

Feature	Windows 98, Me	Windows 2000 and XP	Macintosh OS 9.1, 9.2, and 9.3	Macintosh OS X v. 10.1 and later	UNIX®, Linux	OS/2
Macintosh PostScript printer description (PPD) and printer dialog extensions (PDE)			✓	✓		
IBM drivers						✓ ₁
Model scripts					✓ ₃	

¹Available on the HP Web site.

²HP LaserJet Toolbox software support for Macintosh OS X, v. 10.2 or later.

³Available on the HP Web site. Not specific to this printer.

Software tips

The following are some tips for working with the printer software.

Gaining access to the printer features

The printer features are available in the printer driver. Some features such as custom paper sizes and page orientation might also be available in the program that was used to create a file. Change settings in the program, if possible, because changes that are made in the program override changes that are made in the printer driver.

Obtaining the latest printing software

To check for and install upgrades to the printing software, download drivers from the Internet or HP's file transfer protocol (FTP) servers.

To download drivers

1. Go to www.hp.com. Click the **support & drivers** block.
2. Type `color laserjet 2550` as the product name. The Web page for the drivers might be in English, but you can download the drivers themselves in several languages.

If Internet access is not available, see the flyer that came in the printer box.) See the Readme file for additional release information.

Other print system software

See the Readme file that is provided on the HP color LaserJet 2550 CD-ROM for additional, included software and for supported languages.

Software for Windows

When you install the software for Windows, you can directly connect the printer to a computer by using a USB or parallel cable or, if your printer is network-enabled, you can connect the printer to the network by using the HP Jetdirect print server. See the *HP Color LaserJet 2550 Series Printer Getting Started Guide* for installation instructions, and see the Readme file for the latest software information.

The following software is available to all users of the printer, whether you connected the printer directly to a computer by using a parallel cable or USB cable, or whether you connected the printer to the network by using an HP Jetdirect print server.

Printer drivers

Select a printer driver based on the way the printer is being used.

- Use the PCL 6 printer driver to take full advantage of the printer features. Unless complete backward compatibility with previous PCL drivers or older printers is necessary, the PCL 6 driver is recommended.
- Use the PS printer driver for compatibility with PS needs. Certain printer features are not available in this printer driver.

The printer automatically switches between PS 3 emulation and PCL printer languages depending on the driver you have selected.

Using Help

The printer driver has **Help** dialog boxes that can be activated from the **Help** button in the printer driver, the **F1** key on the computer keyboard, or the question mark symbol (?) in the upper-right corner of the printer driver. These **Help** dialog boxes give detailed information about the specific printer driver. Help for the printer driver is separate from the Help for your program.

HP LaserJet Toolbox

You must perform a complete software installation to use the HP LaserJet Toolbox.

The HP LaserJet Toolbox provides links to printer status information and help information, such as the *HP Color LaserJet 2550 Series Printer User Guide*; and tools for diagnosing and solving problems. You can also view explanations and animations of light messages on the control panel. See [HP LaserJet Toolbox](#) for more information.

Software for network installations only

This software is available only when the printer is connected to a network.

HP Web Jetadmin

HP Web Jetadmin is intended for printer management in commercial and enterprise networks. While the HP LaserJet Toolbox is used to manage a single printer, HP Web Jetadmin is used to manage groups of printers and other devices. Download this software from the HP Web site at <http://www.hp.com/go/webjetadmin>. The HP Web Jetadmin Web site provides HP Web Jetadmin software in many languages.

HP Web Jetadmin is available only if the printer is connected to an Internet protocol- (IP-) based network. This browser-based software can be installed on one of the following supported platforms:

- Microsoft Windows 2000 or XP
- Red Hat Linux
- SuSE Linux

Starting HP Web Jetadmin

After you install the HP Web Jetadmin software, you can start it in a supported Web browser on any computer by typing one of the following Web addresses:

- `http://server.domain:port/`

where "server.domain" is the server hostname and "port" is the port number that you selected during installation. (The default port is 8000.) This information is available in the `url.txt` file, which is stored in the folder where HP Web Jetadmin is installed.

- `http://ipaddress:port/`

where "ipaddress" is the IP address of the computer on which HP Web Jetadmin is installed.

For settings that appear in both the printer driver and HP Web Jetadmin, changes that are made in the printer driver override changes that are made in HP Web Jetadmin.

Software for Macintosh

For Mac 9.1, the Apple LaserWriter 8 driver must be installed to use the PPD file. Use the Apple LaserWriter 8 driver that came with your Macintosh. For Mac OS X, use Print Center to print.

The printer includes the following software for Macintosh computers.

PPDs (Mac OS 9.1 and Mac OS X classic)

PPDs, in combination with the LaserWriter driver, provide access to the printer features and allow the computer to communicate with the printer. An installation program for the PPDs is provided on the HP color LaserJet 2550 CD-ROM.

PDEs (Mac OS X)

PDEs are code plug-ins that provide access to printer features, such as information about the number of copies, two-sided printing, and quality settings. An installation program for the PDEs and other software is provided on the HP color LaserJet 2550 CD-ROM.

HP LaserJet Toolbox

The HP LaserJet Toolbox is supported for Mac OS 10.2 and later. You must perform a complete software installation to use the HP LaserJet Toolbox. The HP LaserJet Toolbox provides links to printer status information and help information, such as the *HP Color LaserJet 2550 Series Printer User Guide*; and tools for diagnosing and solving problems. You can also view explanations and animations of light messages on the control panel. See [HP LaserJet Toolbox](#) for more information.

Uninstalling the printing software

Uninstall software by using the following directions for your operating system.

Uninstalling software for Windows

The printer comes with an uninstall utility that you can use to select and remove any or all of the Windows HP printing system components from your computer.

To uninstall software for Windows 98 and later

Note

To uninstall the software from Windows 2000 or XP, you must log on with administrator privileges.

1. Close all of the open programs.

For Windows 98 and Me

- a. Press **Ctrl+Alt+Delete**. The **Close Program** dialog box opens.
- b. Select a program *except* Explorer or Systray, and then click **End Task**.
- c. Repeat step b until all of the programs except Explorer and Systray are closed.

For Windows 2000 and XP

- a. Press **Ctrl+Alt+Delete**. The **Windows Security** dialog box opens.
 - b. Click **Task Manager** and then click the **Applications** tab.
 - c. Select a program, and then click **End Task**.
 - d. Repeat step c until all of the programs are closed.
2. On the **Start** menu, point to **Programs**, point to **Hewlett-Packard**, point to HP color LaserJet 2550 series, and then click **Add or Remove**.
 3. On the Setup screen, click **Next**.
 4. To remove specific software components, click **Modify the existing installation**. To remove all the printer software, click **Remove All**.

Note

Clicking **Remove All** requires you to have the software CD to complete the uninstallation.

5. Click the drop-down icon next to each feature that you want to remove. From the drop-down list, click **This feature will not be available**.
6. Click **Next**, and follow the directions on the screen. If the message "The following file is a shared file but is not used by any other programs. Would you like to delete it?" appears, click **Yes to All**. The system finishes removing files.
7. If prompted to restart the computer, click **OK**.

Uninstalling software for Windows by using Add or Remove Programs

An alternate method for uninstalling the printer software is to use the **Add or Remove Programs** method. This method does *not* require you to have the software CD.

1. Click **Start**, point to **Settings**, and then click **Control Panel**.
2. Click **Add or Remove Programs**.

3. Scroll through the list of software programs and then click **HP color LaserJet 2550 series printer**.
4. Click **Remove**.

Uninstalling software for Macintosh

To remove the printing software from your Macintosh, drag the HP LaserJet folder and PPDs to the Trash. If you are using Mac OS X, you must also drag the PDEs to the Trash.

For Mac OS 9.1: The PPDs are located in `Macintosh HD\System Folder\Extensions\Printer Descriptions`.

For Mac OS X: The PPDs are located in `Macintosh HD\Library\Printers\PPDs\Contents\Resources\<lang>.lproj`. The PDEs are located in `Macintosh HD\Library\Printers\PPD Plugins\HP*`.

The phrase <lang> represents the language of the printer software that you selected.

Specifications

Table 1-2. Physical specifications

Product	Height	Depth	Width	Weight
HP color LaserJet 2550L printer without optional trays	325 mm (12.80 in)	451 mm (17.76 in)	482 mm (18.98 in)	21.5 kg (47.5 lbs)
HP color LaserJet 2550n printer with tray 2 (250-sheet)	376 mm (14.80 in)	451 mm (17.76 in)	482 mm (18.98 in)	23.9 kg (52.7 lbs)
HP color LaserJet 2550n printer with tray 2 and optional tray 3 (500-sheet)	512 mm (20.16 in)	451 mm (17.76 in)	482 mm (18.98 in)	29.3 kg (64.6 lbs)

Table 1-3. Supplies specifications

Imaging-drum life (based on 5% coverage)	20,000 pages when printing only in black 5,000 pages when printing in color 6,000 to 8,000 pages is the average life
Print-cartridge life (based on 5% coverage)	Black: 5,000 pages Yellow, cyan, and magenta: 2,000 pages each Yellow, cyan, and magenta: 4,000 pages each (HP extended-life color cartridges)

Table 1-4. Electrical specifications

Item	110-volt models	220-volt models
Power supply	115 to 127 V (+/- 10 %)	220 to 240 V (+/- 10 %)
	50 to 60 Hz (+/- 3 Hz)	50 to 60 Hz (+/- 3 Hz)
Power consumption (typical)		
During printing (color)	224 W (average)	217 W (average)
During printing (black and white)	400 W (average)	403 W (average)
During standby	15 W (average)	18 W (average)
Off mode	0 W (average)	0 W (average)
Heat output		
Idle	51 BTU/hr	61 BTU/hr

Table 1-4. Electrical specifications (continued)

Item	110-volt models	220-volt models
Minimum recommended circuit capacity	12 A	6 A

CAUTION

Power requirements are based on the country/region where the printer is sold. Do not convert operating voltages. This will damage the printer and void the product warranty.

Table 1-5. Environmental specifications

	Recommended ¹	Operating ¹	Storage ¹
(printer and print cartridge) Temperature	20° to 27°C (68° to 81°F)	15° to 32.5°C (59° to 90.5°F)	-20° to 40°C (-4° to 104°F)
Relative humidity	20% to 70%	10% to 80%	95% or less

¹Values are subject to change. See www.hp.com/support/clj2550 for current information.

Table 1-6. Acoustic emissions (HP color LaserJet 2550 series)

Sound power	Declared per ISO 9296 ¹
Printing (20 ppm)	$L_{WA_d} = 6.6$ Bels (A)
Sound Pressure	Declared per ISO 9296 ¹
Operator position (printing at 20 ppm)	$L_{pAm} = 62$ dB(A)
Bystander position (printing at 20 ppm)	$L_{pAm} = 52$ dB(A)

¹Values are subject to change. See <http://www.hp.com/support/clj2550> for current information.

Media specifications

This section contains information about the sizes, weights, and capacities of media that each tray supports.

Supported media weights and sizes

This section contains information about the sizes, weights, and capacities of paper and other print media that each tray supports.

Table 1-7. Tray 1 specifications

Tray 1	Dimensions ¹	Weight	Capacity ²
Paper	Minimum: 76 x 127 mm (3 x 5 inches)	60 to 177 g/m ² (16 to 47 lb)	Up to 125 sheets of 75 g/m ² (20 lb) paper
	Maximum: 216 x 356 mm (8.5 x 14 inches)		
Glossy paper	Same as the preceding listed minimum and maximum sizes.	75 to 120 g/m ² (20 to 32 lb)	Maximum stack height: 12 mm (0.47 inches)
HP Cover paper ⁴		203 g/m ² (75 lb cover)	50 (typically)
Transparencies and opaque film		Thickness: 0.10 to 0.13 mm (3.9 to 5.1 mils)	50 (typically)
Labels ³		Thickness: up to 0.23 mm (up to 9 mils)	50 (typically)
Envelopes		Up to 90 g/m ² (16 to 24 lb)	Up to 10

¹The printer supports a wide range of standard and custom sizes of print media. Check the printer driver for supported sizes.

²Capacity can vary depending on media weight and thickness, and environmental conditions.

³Smoothness: 100 to 250 (Sheffield).

⁴HP does not guarantee results when printing with other types of heavy paper.

Table 1-8. Optional tray 2 specifications

Optional tray 2 (250-sheet tray)	Dimensions ¹	Weight	Capacity ²
Letter	216 x 279 mm (8.5 x 11 inches)	60 to 105 g/m ² (16 to 28 lb)	250 sheets of 75 g/m ² (20 lb) paper
A4	210 x 297 mm (8.3 x 11.7 inches)		
A5	148 x 210 mm (5.8 x 8.3 inches)		
B5 (ISO)	176 x 250 mm (6.9 x 9.9 inches)		
B5 (JIS)	182 x 257 mm (7.2 x 10 inches)		
Executive	191 x 267 mm (7.3 x 10.5 inches)		
Legal	216 x 356 mm (8.5 x 14 inches)		
8.5 x 13 inches	216 x 330 mm (8.5 x 13 inches)		

¹The printer supports a wide range of standard and custom sizes of print media. Check the printer driver for supported sizes.

²Capacity can vary depending on the media weight and thickness, and environmental conditions.

Table 1-9. Optional tray 3 specifications

Optional tray 3 (500-sheet tray)	Dimensions ¹	Weight	Capacity ²
Letter	216 x 279 mm (8.5 x 11 inches)	60 to 105 g/m ² (16 to 28 lb)	500 sheets of 75- g/m ² (20-lb) paper
A4	210 x 297 mm (8.3 x 11.7 inches)		

¹The printer supports a wide range of standard and custom sizes of print media. Check the printer driver for supported sizes.

²Capacity can vary depending on the media weight and thickness, and environmental conditions.

General guidelines

Some print media might meet all of the guidelines in this manual and still not produce satisfactory results. This problem might be the result of improper handling, unacceptable temperature and humidity levels, or other variables over which HP has no control.

Before purchasing large quantities of print media, always test a sample and make sure that the print media meets the requirements specified in the *HP Color LaserJet 2550 Series Printer User Guide* and in the *HP LaserJet Printer Family Print Media Guide*. For ordering information, see [Ordering parts and supplies](#).

CAUTION

Using print media that does not meet HP specifications can cause problems for the printer, requiring repair. This repair is not covered by the HP warranty or service agreements.

This printer accepts a variety of media, such as cut-sheet paper (including up to 100% recycled-fiber-content paper), envelopes, labels, transparencies, glossy paper, HP LaserJet Tough paper, and custom-size paper. Properties such as weight, composition, grain, and moisture content are important factors affecting printer performance and output quality. Print media that does not meet the guidelines outlined in this manual can cause the following problems:

- Poor print quality
- Increased jams
- Premature wear on the printer, requiring repair

Paper and print media

Category	Specifications
Acid content	5.5 pH to 8.0 pH
Caliper	0.094 to 0.18 mm (3.0 to 7.0 mils)
Curl in ream	Flat within 5 mm (0.02 inch)
Cut-edge conditions	Cut with sharp blades with no visible fray
Fusing compatibility	Must not scorch, melt, offset, or release hazardous emissions when heated to 210°C (410°F) for 0.1 second
Grain	Long Grain
Moisture content	4% to 6% by weight
Smoothness	100 to 250 Sheffield

For complete print-media specifications for all HP LaserJet printers, see the *HP LaserJet Printer Family Print Media Guide*. To download the guide in PDF format, go to www.hp.com/support/ljpaperguide.

Printing and storage environment

Ideally, the printing and media-storage environment should be at or near room temperature, and not too dry or too humid. Remember that paper is hygroscopic; it absorbs and loses moisture rapidly.

Heat works with humidity to damage paper. Heat causes the moisture in paper to evaporate, while cold causes it to condense on the sheets. Heating systems and air conditioners remove most of the humidity from a room. As paper is opened and used, it loses moisture, causing streaks and smudging. Humid weather or water coolers can cause the humidity to increase in a room. As paper is opened and used it absorbs any excess moisture, causing light print and dropouts. Also, as paper loses and gains moisture it can distort. This issue can cause jams.

As a result, paper storage and handling are as important as the paper-making process itself. Paper storage environmental conditions directly affect the feed operation and print quality.

Care should be taken not to purchase more paper than can be easily used in a short time (about three months). Paper stored for long periods can experience heat and moisture extremes, which can cause damage. Planning is important to prevent damage to a large supply of paper.

Unopened paper in sealed reams can remain stable for several months before use. Opened packages of paper have more potential for environmental damage, especially if they are not wrapped with a moisture-proof barrier.

The media-storage environment should be properly maintained to ensure optimum printer performance. The required condition is 20° to 24°C (68° to 75°F), with a relative humidity of 45% to 55%. The following guidelines should be helpful when evaluating the storage environment:

- Print media should be stored at or near room temperature.
- The air should not be too dry or too humid (to moderate the hygroscopic properties of paper).
- The best way to store an opened ream of paper is to rewrap it tightly in its moisture-proof wrapping. If the printer environment is subject to extremes, unwrap only the amount of paper to be used to prevent unwanted moisture changes.
- Avoid storing paper and print media near heating and air conditioning vents or near windows and doors that are frequently open.

Envelopes

Use only tray 1 to print on envelopes. Select the type of envelope that you are using from the **Print** dialog box or the printer driver.

In your program, set the margins for the envelope. The following table gives typical address margins for a commercial #10 or DL envelope.

Type of address	Top margin	Left margin
Return address	15 mm (0.6 inch)	15 mm (0.6 inch)
Delivery address	51 mm (2 inches)	89 mm (3.5 inches)

- For the best print quality, position margins no closer than 15 mm (0.6 inch) from the edges of the envelope.
- Avoid printing over the area where the envelope seams meet.

Envelope storage

Proper storage of envelopes helps contribute to print quality. Envelopes should be stored flat. If air is trapped in an envelope and creates an air bubble, then the envelope might wrinkle during printing.

For more information, see [Resetting the printer for non-HP supplies](#).

Envelope construction

Envelope construction is critical. Envelope fold lines can vary considerably, not only between manufacturers, but also within a box from the same manufacturer. Successful printing on envelopes depends upon the quality of the envelopes. When selecting envelopes, consider the following components:

- **Weight:** The weight of the envelope paper should not exceed 90 g/m² (24 lb) or jamming might occur.
- **Construction:** Before printing, envelopes should lie flat with less than 6 mm (0.25 inch) curl, and should not contain air.
- **Condition:** Envelopes should not be wrinkled, nicked, or otherwise damaged.
- **Temperature:** Use envelopes that are compatible with the heat and pressure of the printer. The fusing temperature of this printer is 210°C (410°F).
- **Size:** Use only envelopes that are within the following size ranges.
 - **Minimum:** 6 x 127 mm (3 x 5 inches)
 - **Maximum:** 216 x 356 mm (8.5 x 14 inches)

Envelopes with double side-seams

Double side-seam construction has vertical seams at both ends of the envelope rather than diagonal seams. This style might be more likely to wrinkle. Be sure the seam extends all the way to the corner of the envelope as shown in the illustration.

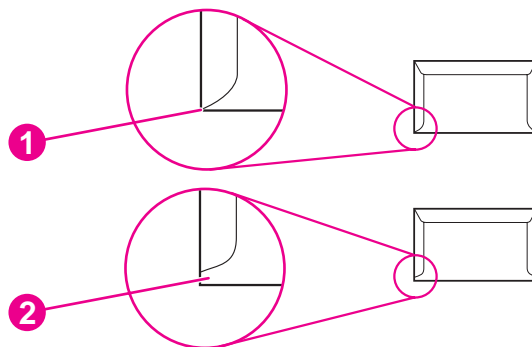

- 1 acceptable
2 unacceptable

Envelopes with adhesive strips or flaps

Envelopes with a peel-off adhesive strip or with more than one flap that folds over to seal must use adhesives that are compatible with the heat and pressure in the printer. The extra flaps and strips might cause wrinkling, creasing, or even jams and might damage the fuser.

Labels

Select the type of label that you are using from the **Print** dialog box or the printer driver.

CAUTION

To avoid damaging the printer, use only labels that are recommended for laser printers. To prevent serious jams, always use tray 1 to print on labels and always use the straight-through paper path. Never print on the same sheet of labels more than once or print on a partial sheet of labels.

When selecting labels, consider the quality of each component:

- **Adhesives:** The adhesive material should be stable at 210°C (410°F), which is the printer fusing temperature.
- **Arrangement:** Only use labels with no exposed backing between them. Labels can peel off sheets with spaces between the labels, causing serious jams.
- **Curl:** Before printing, labels must lie flat with no more than 13 mm (0.5 inch) of curl in any direction.
- **Condition:** Do not use labels that have wrinkles, bubbles, or other indications of separation.

For more information, see [Imaging drum](#).

Transparencies

Use only tray 1 to print on transparencies. Select **Transparencies** from the **Print** dialog box or the printer driver.

The printer supports printing in color on transparencies. Transparencies that are used in the printer must be able to withstand 210°C (410°F), which is the printer fusing temperature.

CAUTION

To avoid damage to the printer, use only transparencies that are recommended for use in laser printers.

For more information, see [Media specifications](#).

Hewlett-Packard limited warranty statement

HP PRODUCT
HP color LaserJet 2550L, 2550Ln, 2550n

DURATION OF LIMITED WARRANTY
1 year, Return to Authorized Service Center

HP warrants to you, the end-user customer, that HP hardware and accessories will be free from defects in materials and workmanship after the date of purchase, for the period specified above. If HP receives notice of such defects during the warranty period, HP will, at its option, either repair or replace products which prove to be defective. Replacement products may be either new or equivalent in performance to new.

HP warrants to you that HP software will not fail to execute its programming instructions after the date of purchase, for the period specified above, due to defects in material and workmanship when properly installed and used. If HP receives notice of such defects during the warranty period, HP will replace software which does not execute its programming instructions due to such defects.

HP does not warrant that the operation of HP products will be uninterrupted or error free. If HP is unable, within a reasonable time, to repair or replace any product to a condition as warranted, you will be entitled to a refund of the purchase price upon prompt return of the product.

HP products may contain remanufactured parts equivalent to new in performance or may have been subject to incidental use.

Warranty does not apply to defects resulting from (a) improper or inadequate maintenance or calibration, (b) software, interfacing, parts or supplies not supplied by HP, (c) unauthorized modification or misuse, (d) operation outside of the published environmental specifications for the product, or (e) improper site preparation or maintenance.

TO THE EXTENT ALLOWED BY LOCAL LAW, THE ABOVE WARRANTIES ARE EXCLUSIVE AND NO OTHER WARRANTY OR CONDITION, WHETHER WRITTEN OR ORAL, IS EXPRESSED OR IMPLIED AND HP SPECIFICALLY DISCLAIMS ANY IMPLIED WARRANTIES OR CONDITIONS OF MERCHANTABILITY, SATISFACTORY QUALITY, AND FITNESS FOR A PARTICULAR PURPOSE. Some countries/regions, states or provinces do not allow limitations on the duration of an implied warranty, so the above limitation or exclusion might not apply to you. This warranty gives you specific legal rights and you might also have other rights that vary from country/region to country/region, state to state, or province to province. HP's limited warranty is valid in any country/region or locality where HP has a support presence for this product and where HP has marketed this product. The level of warranty service you receive may vary according to local standards. HP will not alter form, fit or function of the product to make it operate in a country/region for which it was never intended to function for legal or regulatory reasons.

TO THE EXTENT ALLOWED BY LOCAL LAW, THE REMEDIES IN THIS WARRANTY STATEMENT ARE YOUR SOLE AND EXCLUSIVE REMEDIES. EXCEPT AS INDICATED ABOVE, IN NO EVENT WILL HP OR ITS SUPPLIERS BE LIABLE FOR LOSS OF DATA OR FOR DIRECT, SPECIAL, INCIDENTAL, CONSEQUENTIAL (INCLUDING LOST PROFIT OR DATA), OR OTHER DAMAGE, WHETHER BASED IN CONTRACT, TORT, OR OTHERWISE. Some countries/regions, states or provinces do not allow the exclusion or limitation of incidental or consequential damages, so the above limitation or exclusion may not apply to you.

THE WARRANTY TERMS CONTAINED IN THIS STATEMENT, EXCEPT TO THE EXTENT LAWFULLY PERMITTED, DO NOT EXCLUDE, RESTRICT OR MODIFY AND ARE IN ADDITION TO THE MANDATORY STATUTORY RIGHTS APPLICABLE TO THE SALE OF THIS PRODUCT TO YOU.

Limited warranty for the print cartridges and imaging drum

This HP product is warranted to be free from defects in materials and workmanship during its useful life (end of life is indicated by a printer control panel low-life message).

This warranty does not cover products that have been modified, refurbished, remanufactured, misused, or tampered with in any way.

This limited warranty gives you specific legal rights. You may have other rights which vary from state to state, province to province, and country/region to country/region.

The above warranties are exclusive and no other warranty, whether written or oral, is expressed or implied. The Hewlett-Packard Company specifically disclaims the implied warranties or merchantability and fitness for a particular purpose. To the extent allowed by applicable law, in no event shall Hewlett-Packard Company be liable for any incidental, consequential, special, indirect, punitive, or exemplary damages or lost profits from any breach of this warranty or otherwise.

In the event that your product proves to be defective, please return to place of purchase with a written description of the problem.

Print cartridge information

At 5% page coverage, a black print cartridge will print approximately 5,000 pages. Color print cartridges (yellow, cyan, and magenta) will print 2,000 pages each, and extended-life color print cartridges (yellow, cyan, and magenta) will print 4,000 pages each. These estimates are only approximate; usage conditions and print patterns can cause results to vary.

Refilled print cartridges

While HP does not prohibit the use of refilled print cartridges during the warranty period or while the product is under a maintenance contract, it is not recommended for the following reasons:

- Repairs resulting from the use of refilled cartridges are not covered under HP warranty or maintenance contracts.
- HP has no controls or processes to ensure that a refilled cartridge functions at the high level of reliability of a new HP LaserJet print cartridge. HP also cannot predict the long-term reliability effect on the product from using different toner formulations found in refilled cartridges.
- The print quality of HP LaserJet print cartridges influences the customer's perception of the product. HP has no control over the actual print quality of a refilled cartridge.
- Parts that are critical to print quality might not be replaced when the cartridge is refilled with toner.

HP LaserJet printing supplies

In many countries/regions, this product's printing supplies (for example the print cartridge) can be returned to HP through the HP Printing Supplies Returns and Recycling Program. An easy-to-use and free take-back program is available in more than 30 countries/regions. Multilingual program information and instructions are included in every new HP LaserJet print cartridge and supplies package.

HP Printing Supplies Returns and Recycling Program information

Since 1990, the HP Printing Supplies Returns and Recycling Program has collected millions of used LaserJet print cartridges that otherwise might have been discarded in the world's landfills. The HP LaserJet print cartridges and supplies are collected and bulk shipped to our resource and recovery partners, who disassemble the cartridges. Remaining materials are separated and converted into raw materials for use by other industries to make a variety of useful products.

U.S. returns

For a more environmentally responsible return of used cartridges and supplies, HP encourages the use of bulk returns. Simply bundle two or more cartridges together and use the single, pre-paid, pre-addressed UPS label that is supplied in the package that the new cartridge comes in. For more information in the U.S., call 800-340-2445 or visit the HP LaserJet Supplies Web site at www.hp.com/recycle.

Non-U.S. returns

Non-U.S. customers should call the local HP Sales and Service office or visit the www.hp.com/recycle Web site for further information regarding availability of the HP Supplies Returns and Recycling program.

Regulatory statements

Declaration of Conformity

according to ISO/IEC Guide 22 and EN 45014

Manufacturer's Name: Hewlett-Packard Company
Manufacturer's Address: 11311 Chinden Boulevard
Boise, Idaho 83714-1021, USA

declares, that the product

Product Name: HP color LaserJet 2550L/2550Ln/2550n
Regulatory Model Number⁴⁾: BOISB-0305-00. Including: Q3709A - Optional 250-sheet input tray; Q3710A - Optional 500-sheet input tray
Product Options: ALL

conforms to the following Product Specifications:

Safety: IEC 60950:1999 / EN60950:2000
IEC 60825-1:1993+A1:1997 +A2:2001 / EN 60825-1:1994+A11:1996 +A2:2001 (Class 1 Laser/LED Product)
GB4943-2001

EMC: CISPR 22:1997 / EN 55022:1998 Class B^{1) 3)}
EN 61000-3-2:2000
EN 61000-3-3:1995 / A1
EN 55024:1998
FCC Title 47 CFR, Part 15 Class B²⁾ / ICES-003, Issue 3/ GB9254-1998, GB17625.1-1998 / CNS 13438

Supplementary Information:

The product herewith complies with the requirements of the EMC Directive 89/336/EEC and the Low Voltage Directive 73/23/EEC, and carries the CE-marking accordingly.

1) The product was tested in a typical configuration with Hewlett-Packard Personal Computer Systems. Compliance testing of product to standard with exception of Clause 9.5, which is not yet in effect.

2) This Device complies with Part 15 of the FCC Rules. Operation is subject to the following two conditions: (1) this device may not cause harmful interference, and (2) this device must accept any interference received, including interference that may cause undesired operation.

3) This product includes LAN (Local Area Network) options. When the interface cable is attached to LAN connectors, the product meets the requirements of EN55022 & CNS13438 Class A in which case the following applies: "Warning — This is a class A product. In a domestic environment this product may cause radio interference in which case the user may be required to take adequate measures."

3) For regulatory purposes, this product is assigned a Regulatory model number. This number should not be confused with the product name or the product number(s).

Boise, Idaho , USA

1 April, 2004

For regulatory topics only:

Australia Contact: Product Regulations Manager, Hewlett-Packard Australia Ltd. 31-41 Joseph Street Blackburn, Victoria 3130, Australia

European Contact: Your Local Hewlett-Packard Sales and Service Office or Hewlett-Packard GmbH, Department HQ-TRE / Standards Europe Herrenberger Straße 140 Böblingen, D-71034, +49-7031-14-3143

USA Contact: Product Regulations Manager, Hewlett-Packard Company PO Box 15, Mail Stop 160 Boise, ID 83707-0015, USA (Phone: 208-396-6000)

Safety statements

Laser safety statement

The Center for Devices and Radiological Health (CDRH) of the U.S. Food and Drug Administration has implemented regulations for laser products manufactured since August 1, 1976. Compliance is mandatory for products marketed in the United States. The printer is certified as a "Class 1" laser product under the U.S. Department of Health and Human Services (DHHS) Radiation Performance Standard according to the Radiation Control for Health and Safety Act of 1968.

Since radiation emitted inside the printer is completely confined within protective housings and external covers, the laser beam cannot escape during any phase of normal user operation.

WARNING!

Using controls, making adjustments, or performing procedures other than those specified in the *HP Color LaserJet 2550 Series Printer User Guide* may result in exposure to hazardous radiation.

Canadian DOC statement

Complies with Canadian EMC Class B requirements.

«Conforme à la classe B des normes canadiennes de compatibilité électromagnétiques (CEM).»

Korean EMI statement

사용자 안내문 (B 급 기기)

이 기기는 비업무용으로 전자파장해검정을 받은 기기로서, 주거지역에서는 물론 모든 지역에서 사용할 수 있습니다.

Finnish laser statement

LASERTURVALLISUUS

LUOKAN 1 LASERLAITE

KLASS 1 LASER APPARAT

HP color LaserJet 2550L, 2550Ln, 2550n -laserkirjoitin on käyttäjän kannalta turvallinen luokan 1 laserlaite. Normaalisissa käytössä kirjoittimen suojakotelointi estää lasersäteiden pääsyn laitteen ulkopuolelle.

Laitteen turvallisuusluokka on määritetty standardin EN60825-1 (1994) mukaisesti.

VAROITUS!

Laitteen käyttäminen muulla kuin käyttöohjeessa mainitulla tavalla saattaa altistaa käyttäjän turvallisuusluokan 1 ylittävälle näkymättömälle lasersäteilylle.

WARNING!

Om apparaten används på annat sätt än i bruksanvisning specificerats, kan användaren utsättas för osynlig laserstrålning, som överskrider gränsen för laserklass 1.

HUOLTO

HP color LaserJet 2550L, 2550Ln, 2550n -kirjoittimen sisällä ei ole käyttäjän huollettavissa olevia kohteita. Laitteen saa avata ja huoltaa ainoastaan sen huoltamiseen koulutettu henkilö. Tällaiseksi huoltotoimenpiteeksi ei katsota väriainekasetin vaihtamista, paperiradan puhdistusta tai muita käyttäjän käsikirjassa lueteltuja, käyttäjän tehtäväksi tarkoitettuja ylläpitotoimia, jotka voidaan suorittaa ilman erikoistyökaluja.

VARO!

Mikäli kirjoittimen suojakotelo avataan, olet alttiina näkymättömälle lasersäteilylle laitteen ollessa toiminnassa. Älä katso säteeseen.

WARNING!

Om laserprinterns skyddshölje öppnas då apparaten är i funktion, utsättas användaren för osynlig laserstrålning. Betrakta ej strålen.

Tiedot laitteessa käytettävän laserdiodin säteilyominaisuuksista:

Aallonpituus 770-800 nm

Teho 5 mW

Luokan 3B laser

2

Installation and operation

Chapter contents

Chapter contents	31
Operating environment	32
Interface ports	33
Control panel features	34
Understanding Supplies Status	34
Understanding Printer Status	35
Input trays	37
Printer output paths	38
Top output bin	38
Rear output door	38
Loading media	39
Loading tray 1	39
Loading optional tray 2	40
Loading optional tray 3	42
HP LaserJet Toolbox	44
Supported operating systems	44
Supported browsers	44
Viewing the HP LaserJet Toolbox	45
Status tab	45
Troubleshooting tab	45
Alerts tab	46
Documentation tab	46
Device Settings window	47
Other links	48

Operating environment

Place the printer on a sturdy, level surface in a well-ventilated area that meets the following environmental requirements:

- temperature: 15° to 32.5° C (59° to 90.5° F)
- humidity: 10 percent to 80 percent relative humidity (no condensation)
- away from direct sunlight, open flames, and ammonia fumes
- with sufficient space around the printer for access and ventilation

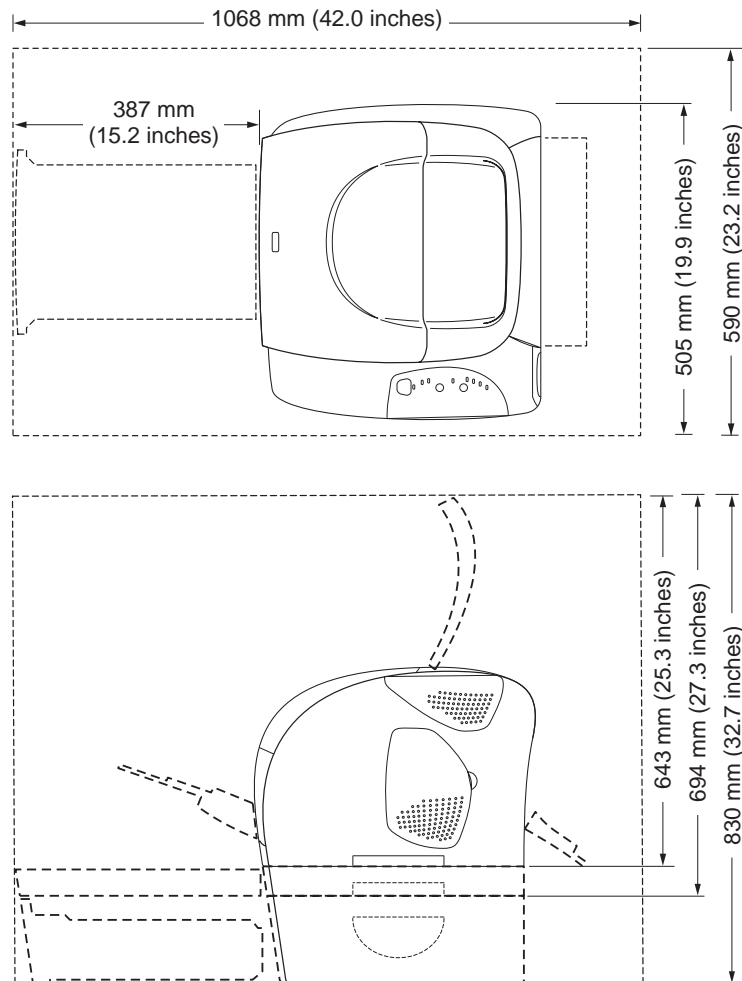
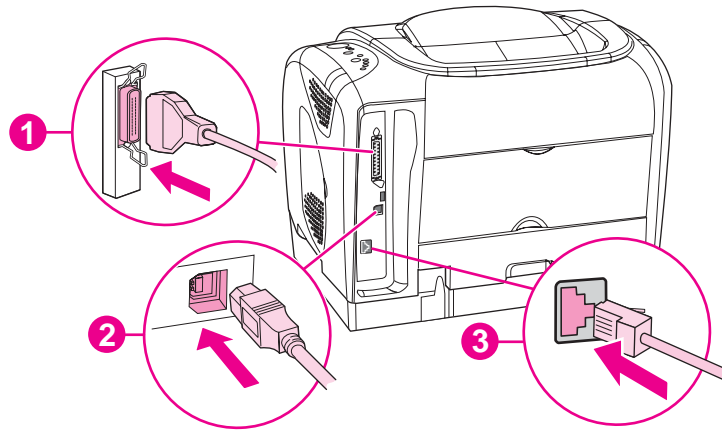

Figure 2-1. Space required

Interface ports

The printer has two interface ports: an IEEE-1284B parallel port and a high-speed USB port. The HP color LaserJet 2550Ln and 2550n models include an HP Jetdirect internal print server that contains a 10/100Base-T (RJ-45) port.



- 1 Parallel port (IEEE-1284B)
- 2 High-speed USB port
- 3 10/100Base-T port (HP color LaserJet 2550Ln and 2550n printers only)

Control panel features

The printer contains the following lights and buttons on the control panel:

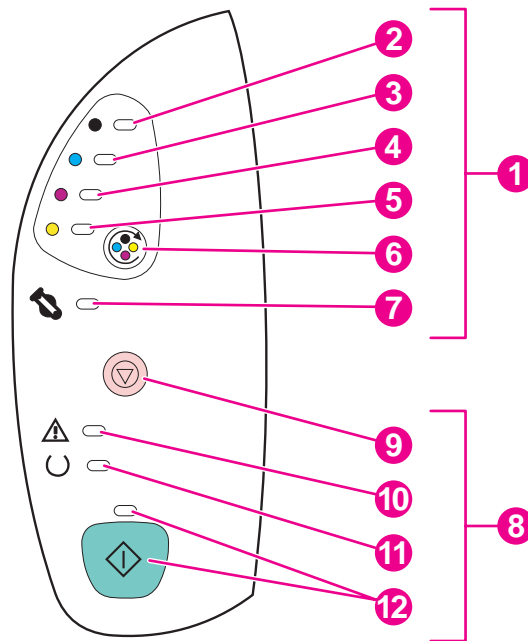

- 1 **Supplies status lights and buttons**
- 2 Black print-cartridge light
- 3 Cyan print-cartridge light
- 4 Magenta print-cartridge light
- 5 Yellow print-cartridge light
- 6 **ROTATE CAROUSEL** button
- 7 Imaging drum light
- 8 **Printer status lights and buttons**
- 9 **CANCEL JOB** button
- 10 Attention light (amber)
- 11 Ready light (green)
- 12 Go light and **Go** button (both green)

The lights and buttons are arranged into two main groups: Supplies Status (top) and Printer Status (bottom). To interpret and troubleshoot the control panel light messages, see [Control panel light messages](#).

Understanding Supplies Status

The printer contains five lights and one button to indicate and control the status of the print cartridges and imaging drum. To interpret and troubleshoot control panel light messages, see [Control panel light messages](#).

Black, Cyan, Magenta, and Yellow Supplies Status lights

These lights indicate when a print cartridge is low (the light is on), or empty or missing (the light blinks). The lights also indicate when a non-HP print cartridge is installed (the light blinks and the Attention light is on).

Rotate Carousel button

When the top cover is closed, pressing  (ROTATE CAROUSEL) rotates the print-cartridge carousel to bring the next print cartridge into the top position. The light for the print cartridge that is approaching the top position blinks quickly two or three times.





Imaging drum light

This light indicates when the imaging drum is low (light is on), or empty or missing (light blinks). The light also indicates when a non-HP imaging drum is installed (the light blinks and the Attention light is on).

Understanding Printer Status

The printer has two buttons and three lights to indicate and control the printer status. To interpret and troubleshoot the control panel light messages, see [Control panel light messages](#).

Cancel Job button

- When the Ready light is blinking, pressing  (CANCEL JOB) cancels the current job.
- When the printer is not experiencing an error, pressing  (Go) and  (CANCEL JOB) simultaneously prints a Configuration page and a Supplies Status page. (If an HP Jetdirect print server is installed, an HP Jetdirect page also prints.)
- When a Supplies Status light is blinking and the Attention light is on (indicating that a non-HP supply has been installed), pressing  (CANCEL JOB) allows you to continue printing.

CAUTION

You might not receive any indication when a non-HP supply is empty. If you continue printing after the supply is empty, damage to the printer can occur. See [Hewlett-Packard limited warranty statement](#).

Attention light







Generally, the Attention light blinks when the printer is out of paper, when a jam has occurred, or when other problems that need attention occur.

The Attention light is on and one of the Supplies Status lights is blinking the first time a non-HP supply is installed.

Ready light

The Ready light is on when the printer is ready to print (experiencing no errors that prevent printing) and blinks when it is receiving data to be printed.

Go light and Go button

- When the Go light is on and the Attention light is blinking, pressing  (Go) continues the print job after you load print media for a manual feed, or clears some errors.
- When the Go light is blinking, the top cover has been opened and then closed or you have pressed  (ROTATE CAROUSEL). Pressing  (Go) returns the printer to the Ready state. If you do not press  (Go), the printer returns to the Ready state on its own.
- When the Go light is off, pressing  (Go) prints a Demo page. Pressing  (Go) and  (CANCEL JOB) simultaneously prints a Configuration page and a Supplies Status page. (If an HP Jetdirect print server is installed, an HP Jetdirect page also prints.)

Input trays

The HP color LaserJet 2550 series printer comes with one or more input trays. See [Table 2-1. Input tray configuration](#) for configuration information.

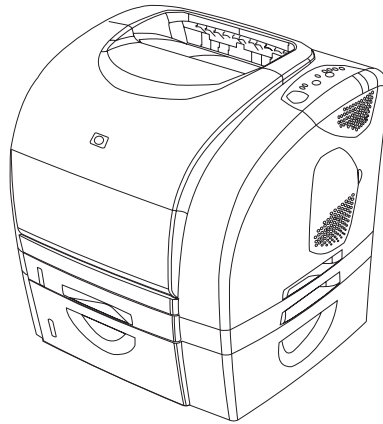

Figure 2-2. Standard and optional input trays—HP color LaserJet 2550 series printers

Table 2-1. Input tray configuration

Printer model	Standard input trays	Optional input trays
HP color LaserJet 2550L	tray 1 (125-sheet)	tray 2 (250-sheet) tray 3 (500-sheet)
HP color LaserJet 2550Ln	tray 1 (125-sheet)	tray 2 (250-sheet) tray 3 (500-sheet)
HP color LaserJet 2550n	tray 1 (125-sheet) tray 2 (250-sheet)	tray 3 (500-sheet)

Note

Because tray 2 and tray 3 are not included with all models, they are referred to as optional tray 2 and optional tray 3 in this documentation.

Optional tray 2 must be installed in order to install optional tray 3.

By default, the printer draws first from tray 1. If tray 1 is empty, the printer draws first from optional tray 3 (if installed) and then from optional tray 2.

Printer output paths

The printer comes with the top output bin and rear output door for printing to a straight-through paper path. Print jobs emerge from the top output bin when the rear output door is closed. Print jobs emerge from the back of the printer when the rear output door is open.

Top output bin

Use the top output bin when printing most jobs, including jobs on average-weight paper and letterhead, and transparencies. The top output bin can hold up to 125 sheets. Prevent more than 125 sheets from accumulating in the top output bin, or jams can occur.

Rear output door

Print jobs emerge from the back of the printer when the rear output door is open. Use the rear output door (straight-through paper path) when printing envelopes, labels, heavy- or lightweight paper, and other thick or special print media. Remove each sheet as it exits the printer.

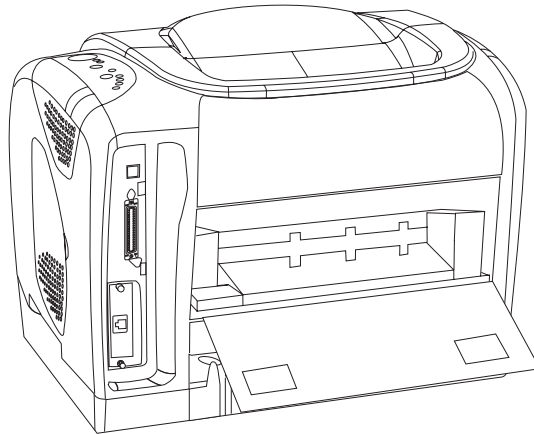

Figure 2-3. Printer output paths

Loading media

Load special print media such as envelopes, labels, custom-size media, and transparencies in tray 1 only. Load only paper in optional tray 2 or optional tray 3.

Loading tray 1

Tray 1 (multipurpose tray) holds up to 125 sheets of paper or other print media, or up to 10 envelopes.

To load tray 1

CAUTION

Avoid adding print media to tray 1 while the printer is printing, or jams can occur.

1. Open tray 1.

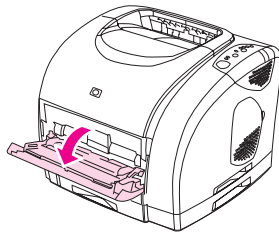

2. Slide out the tray extender. If the print media being loaded is longer than 229 mm (9 inches), also open the additional tray extender.

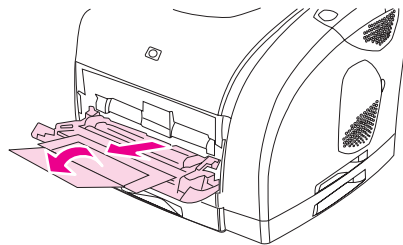

3. Slide the width guides slightly wider than the print media.

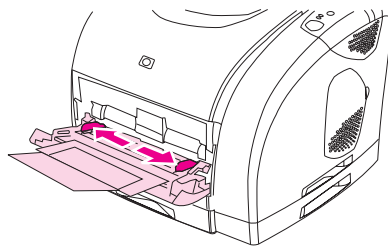

4. Place print media into the tray with the side to be printed up, and the top, short edge in first.

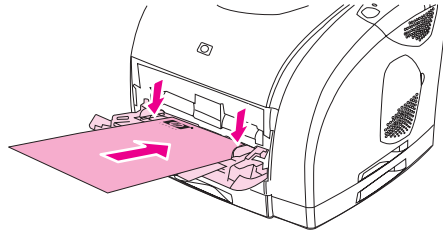

Note

If you are manually duplexing, see the *HP Color LaserJet 2550 Series Printer User Guide* for loading instructions.

5. Slide the paper width guides inward until they lightly touch the print media stack on both sides without bending it. Make sure that the print media fits under the tabs on the width guides.

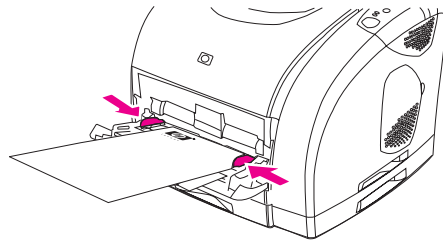

CAUTION

If you choose to close tray 1, first wait for the printer to finish printing. Closing the tray before printing is complete can cause jams.

6. On the back of the printer, lower the rear output door if you are printing on special media, such as labels, envelopes, or heavy or light paper, to prevent curl.

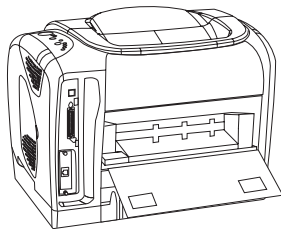

Loading optional tray 2

Optional tray 2 supports standard-size paper only, including average-weight letterhead and prepunched paper. For additional information about loading letterhead and prepunched paper, see the *HP Color LaserJet 2550 Series Printer User Guide*.

CAUTION

Print special print media such as labels and transparencies from tray 1 only. Printing special print media from optional tray 2 or optional tray 3 can cause jams.

To load optional tray 2

1. Pull optional tray 2 out of the printer and remove any paper.

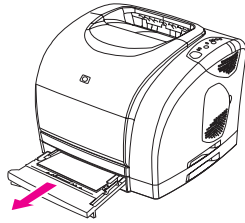

2. Move the side width guides to match the size of paper you are loading.

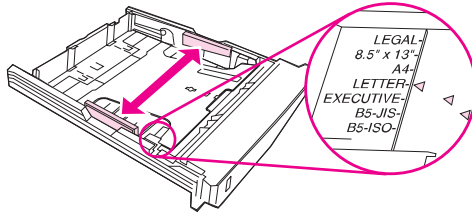

3. Extend the rear of the tray until the arrow points to the size you are loading.

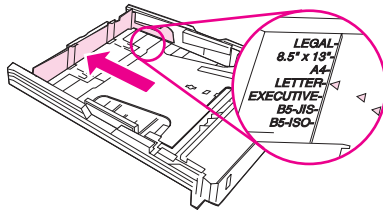

4. Load the paper. If this is special paper such as letterhead, load it with the side to be printed facing down and the top edge toward the front of the tray.

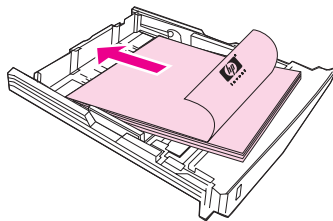

Note

If you are manually duplexing, see the *HP Color LaserJet 2550 Series Printer User Guide* for loading instructions.

5. Make sure that the stack of paper is flat in the tray at all four corners, and keep it below the height tabs on the paper length guide in the rear of the tray. Push down on the metal paper-lift plate to lock it into place.

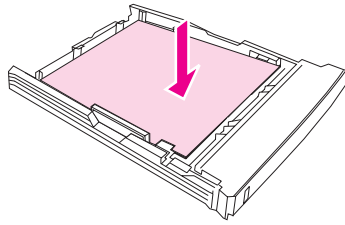

6. Slide the tray back into the printer. If you set the rear of the tray to one of the longer sizes, the back of the tray will protrude from the back of the printer.

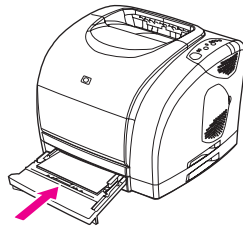

Loading optional tray 3

The optional tray 3 supports A4- and letter-size paper. Optional tray 3 supports only paper, which includes average-weight letterhead and prepunched paper.

For additional information about letterhead and prepunched paper, see the *Series Printer User*.

CAUTION

Print special print media such as labels and transparencies from tray 1 only. Printing special print media from optional tray 2 or optional tray 3 can cause jams.

To load optional tray 3

1. Pull the tray out of the printer and remove any paper.

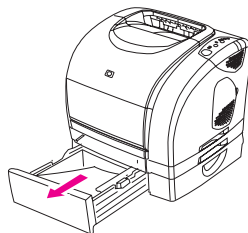

2. For letter-size paper, pull up the rear stop. For A4-size paper, push down the rear stop.

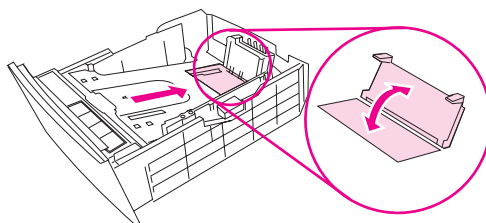

3. For letter-size paper, move the side width guides outward as far as possible. For A4-size paper, move the side width guides inward as far as possible.

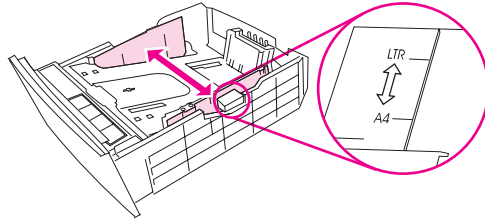

4. Load the paper. If this is special paper such as letterhead, load it with the side to be printed facing down and the top edge toward the front of the tray.

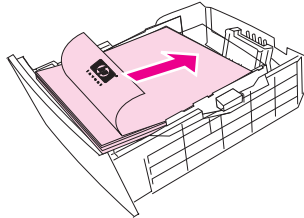

Note

If you are manually duplexing, see the *HP Color LaserJet 2550 Series Printer Series Printer User* for loading instructions.

5. Make sure that the stack of paper is flat in the tray at all four corners, and keep it below the height tabs on the length guide in the rear of the tray.

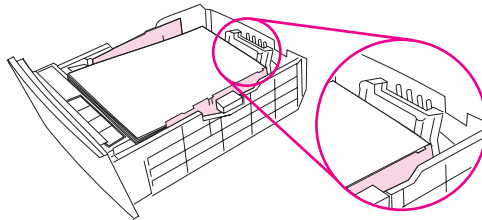

6. Slide the tray back into the printer.

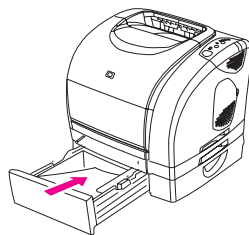

HP LaserJet Toolbox

The HP LaserJet Toolbox is a Web application that you can use for the following tasks:

- Check the printer status.
- Configure the printer settings.
- View troubleshooting information.
- View online documentation.

You can view the HP LaserJet Toolbox when the printer is directly connected to your computer or when it is connected to the network. You must perform a complete software installation to use the HP LaserJet Toolbox.

Note

You do not have to have Internet access to open and use the HP LaserJet Toolbox. However, if you click a link in the **Other Links** area, you must have Internet access to go to the site that is associated with the link. See [Other links](#) for more information.

Supported operating systems

The HP LaserJet Toolbox is supported for the following operating systems:

- Windows 98, 2000, Me, and XP
- Mac OS X, v. 10.2, or later

Supported browsers

To use the HP LaserJet Toolbox, you must have one of the following browsers:

Windows

- Microsoft Internet Explorer 5.5 or later
- Netscape Navigator 6.2 or later
- Opera Software ASA Opera 7 or later

Macintosh (OS X, v. 10.2 or later, only)

- Microsoft Internet Explorer 5.1 or later
- Netscape Navigator 6.23 or later
- Safari 1.0

All pages can be printed from the browser.

Viewing the HP LaserJet Toolbox

1. Open the HP LaserJet Toolbox in one of these ways:
 - On the Windows desktop, double-click the HP LaserJet Toolbox icon.
 - On the Windows **Start** menu, point to **Programs**, and then click the **HP LaserJet Toolbox**.
 - For Macintosh OS X, on the hard drive, click **Applications**, and then click the **Utilities** folder. Double-click the **HP LaserJet Toolbox icon**.

Note

After you open the URL, you can bookmark it so that you can return to it quickly in the future.

2. The HP LaserJet Toolbox opens in a Web browser. The HP LaserJet Toolbox software contains the following sections:
 - [Status tab](#)
 - [Troubleshooting tab](#)
 - [Alerts tab](#)
 - [Documentation tab](#)
 - [Device Settings window](#)
 - [HP LaserJet Toolbox links](#)
 - [Other links](#)

Status tab

The **Status** tab has links to the following main pages:

- **Device Status.** View printer status information. This page indicates printer conditions such as a jam or an empty tray. After you correct a problem with the printer, click the **Refresh** button to update the device status.
- **Supplies Status.** View detailed supplies status such as the percent of toner remaining in the print cartridge and the number of pages that have been printed with the current print cartridge. This page also has links to order supplies and to find recycling information.
- **Print Info.** Print the configuration page and various other information pages that are available for the printer, such as the supplies status page and the demo page.

Troubleshooting tab

The **Troubleshooting** tab has links to the following main pages:

- **Printer Lights.** Click the control panel lights on this simulator to find help for a specific control panel light pattern. For several conditions, animated video clips are available that demonstrate the recommended action to solve the problem.
- **Print Quality Tools.** Print a page that assists in solving print-quality problems, view information about print-quality problems, print the cleaning page and clean the printer, and calibrate the printer to maintain color print quality.
- **Maintenance.** Print the cleaning page and clean the printer, view information about printer supplies, and view animated demos of how to replace the print cartridges and the imaging drum.

- **Paper Jams.** View information on locating and clearing jams, and view an animated demo of how to clear jams.
- **Supported Media.** View information about media that the printer supports, and view information about solving problems related to print media.
- **Demo Page.** Print the Demo page for this printer.

Alerts tab

Use the **Alerts** tab to configure the printer to automatically notify you of printer alerts. The **Alerts** tab has links to the following main pages:

- Set up status alerts
- Set up e-mail alerts
- Administrative settings

Set up status alerts page

On the Set up status alerts page, you can choose to turn alerts on or off, specify when the printer should send an alert, and select from two different types of alerts:

- Pop-up message
- Taskbar icon

Click **Apply** to activate the settings.

Set up e-mail alerts page

On the Set up e-mail alerts page, you can set the e-mail addresses that you want to have alerts sent to, and specify what kind of alerts should go to which e-mail addresses. You can have two e-mail destinations for the following alerts:

- Supplies
- Service
- Paper path
- Advisory

You must set up a simple mail transfer protocol (SMTP) server to send e-mail alerts.

Documentation tab

The **Documentation** tab contains links to these information sources:

- **Print: How Do I?** Contains information about how to use the printer to print different types of print jobs (for example, how to manually duplex).
- **Series Printer User.** Contains the information about the printer usage, warranty, specifications, and support that you are currently reading. The Series Printer User is available in both HTML and PDF format.
- **Readme.** Contains important information about the printer that is not available in the Series Printer User. The Late-Breaking Readme contains last-minute information about the printer (in English only).

Device Settings window

When you click the **Device Settings** button, a new window opens. The Device Settings window has the following sections:

- **Information** tab
- **Settings** tab
- **Network** link

Information tab

The Information tab provides quick links to the following information:

- **Device Status.** View information about the printer's current status.
- **Supplies Status.** View information about the supplies installed in the printer. A link is provided to the HP Web site for ordering supplies.
- **Event Log.** View a history of printer errors. The most recent error is at the top of the list.
- **Save/Restore Settings.** Save the current settings for the printer to a file on your computer. Use this file to load the same settings onto another printer or to restore these settings to this printer at a later time.
- **Device Configuration.** View a detailed description of the printer's current configuration including the amount of memory installed and whether optional trays are installed.

Settings tab

The **Settings** tab has links to several pages where you can view and change the printer's configuration.

Note

Software settings can override settings that are made in the HP LaserJet Toolbox.

- **Device Information.** View basic information about the printer.
- **Paper Handling.** View and change the settings for the printer's trays.
- **Printing.** View and change the default printer job settings.
- **PCL.** View and change the PCL font information.
- **PostScript.** View and change settings for PS errors and timeout.
- **Print Quality.** View and change the print-quality settings.
- **Print Modes.** View and change the print modes for various media types.
- **System Setup.** View and change system information.
- **I/O.** View and change the I/O timeout setting.
- **Service.** Gain access to various procedures required to service the printer.

Network window

The network administrator can use the **Network** window to control the network-related settings for the printer when it is connected to an IP-based network. This button will not appear if the printer is directly connected to a computer, or if the printer is connected to a network through anything other than an HP Jetdirect print server.

HP LaserJet Toolbox links

The HP LaserJet Toolbox links at the left of the screen provide links to the following options:

- **Select a device.** Select from all of the HP LaserJet Toolbox-enabled devices.
- **View current alerts.** View the current alerts for all printers that have been set up. (You must be printing to view the current alerts.)
- **Text only page.** View the HP LaserJet Toolbox as a site map that links to text-only pages.

Other links

This section contains links that connect you to the Internet. You must have Internet access in order to use any of these links. If you use a dial-up connection and did not connect when you first opened the HP LaserJet Toolbox, you must connect before you can visit these Web sites. Connecting might require that you close the HP LaserJet Toolbox and reopen it.

- **HP Instant Support.**
- **Product Registration.** Connects to the HP product registration Web site.
- **Product Support.** Connects to the support site for the HP color LaserJet 2550 series printer. Then, you can search for help with a specific problem.

3

Maintenance

Chapter contents

Chapter contents	49
Life expectancies of supplies	50
User-replaceable parts	52
Replacing the tray 1 pickup roller and separation pad	52
Replacing the separation pad in optional tray 2 or in optional tray 3	57
Cleaning the printer	61
Cleaning the printer	61
Calibrating the printer	63
To calibrate the printer at the printer	63
To calibrate the printer from the HP LaserJet Toolbox	63
Managing supplies	64
Supplies life	64
Checking and ordering supplies	64
Storing supplies	65
Replacing and recycling supplies	65
HP policy for non-HP supplies	66
HP fraud hotline	66

Life expectancies of supplies

Inspect supplies when you service the printer. Replace supplies as needed, based on failure or wear, rather than on usage.

The following table lists approximate schedules for replacing supplies.

Table 3-1. Life expectancies of supplies

Description	Part number	Estimated life (in number of pages at 5 percent coverage ¹)	Remarks
Print cartridge, black (user replaceable)	Q3960-67901 Q3960-67902 (EMEA)	5,000	
Print cartridge, cyan (user replaceable)	Q3971-67901 Q3971-67902 (EMEA)	2,000	
Print cartridge, cyan (user replaceable)	Q3961-67901 Q3961-67902 (EMEA)	4,000	Extended-life cartridge
Print cartridge, yellow (user replaceable)	Q3972-67901 Q3972-67902 (EMEA)	2,000	
Print cartridge, yellow (user replaceable)	Q3962-67901 Q3962-67902 (EMEA)	4,000	Extended-life cartridge
Print cartridge, magenta (user replaceable)	Q3973-67901 Q3973-67902 (EMEA)	2,000	
Print cartridge, magenta (user replaceable)	Q3963-67901 Q3963-67902 (EMEA)	4,000	Extended-life cartridge
Imaging drum	Q3964-67901	20,000 (black only) 5,000 (color)	The average life is 6,000 to 8,000 pages.
Transfer roller	RF5-4067-000CN		Can affect print quality and paper movement.
Printer pickup roller	RB3-0160-000CN		Look for glazing and/or cracks.
Printer separation pad	RF5-4012-000CN		Can affect document movement.
Fuser assembly, 110-127 V)	RG5-7572-000CN		Can affect print quality and document movement.
Fuser assembly, 220-240 V)	RG5-7573-000CN		Can affect print quality and document movement.
Separation pad, optional trays 2 and 3	RB2-9960-000CN		Can affect document movement.

¹The estimated print cartridge life is based on letter- or A4-sized paper with an average of 5% toner coverage and a medium density setting. Print cartridge life can be extended further by conserving toner by using draft-mode settings.

User-replaceable parts

Pickup rollers and separation pads are user-replaceable parts.

Replacing the tray 1 pickup roller and separation pad

1. Turn the printer off and disconnect the power cable from the back of the printer.

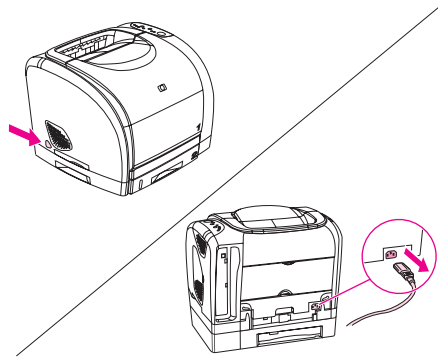

2. Open tray 1.

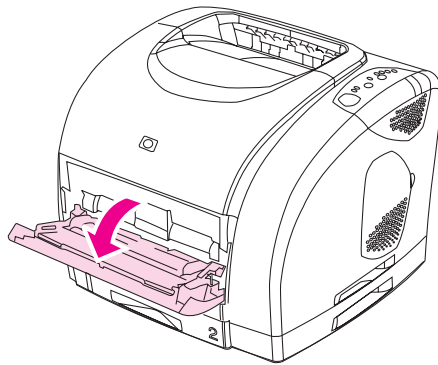

3. Find the faceplate cover that is located beneath the pickup roller in tray 1.

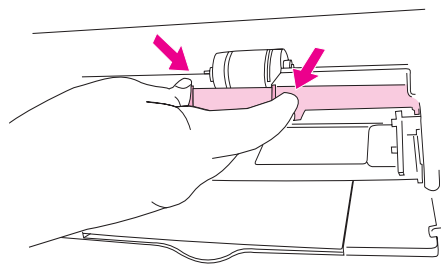

4. Grasp both sides of the center tab and pull the cover out of the printer.

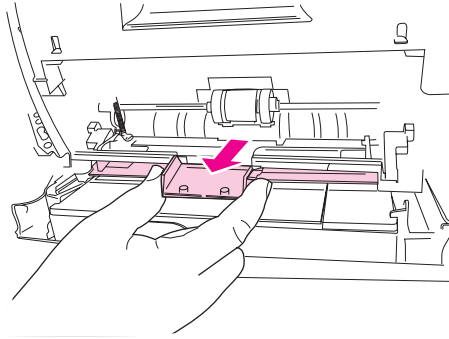

5. Squeeze the tab on the idler roller that is located on the right side of the pickup roller. If the tab is not visible, rotate the idler roller so that the tab is toward the front of the printer.

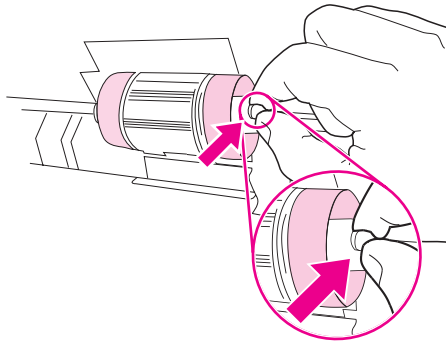

6. Slide the idler roller to the right to separate it from the pickup roller.

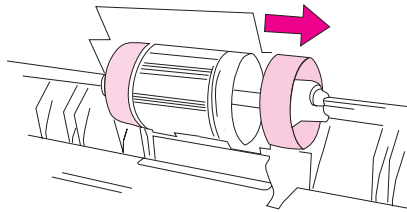

7. Squeeze the tab on the idler roller that is located on the left side of the pickup roller. If the tab is not visible, rotate the idler roller so that the tab is toward the front of the printer.

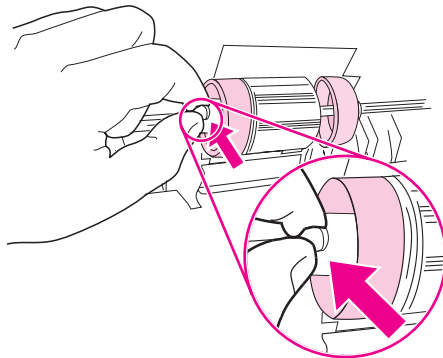

- Slide the idler roller to the left to separate it from the pickup roller.

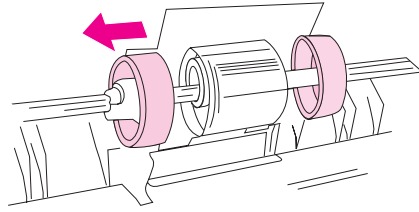

- Press and hold the button that is located on the right side of the pickup roller. Slide the pickup roller slightly to the right, and then pull it off of the shaft.

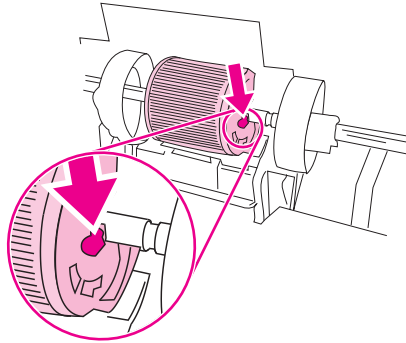

CAUTION

To prevent the shaft retaining pin from falling out, do not move the remaining hub that is located to the left of the pickup roller.

- Locate the separation pad beneath the area of the shaft from which the pickup roller was removed.

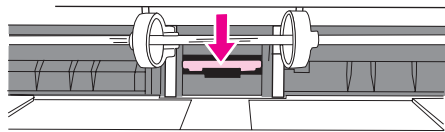

11. Insert a flatblade screwdriver into the slot under the separation pad. Pry the pad up from the spring-loaded base by twisting the screwdriver until the tabs are separated from the printer.

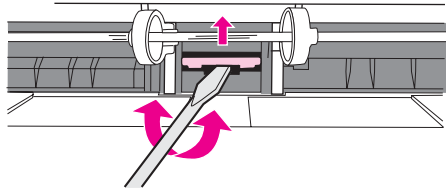

12. Use one hand to push the spring-loaded base down and then use the other hand to pull the separation pad up and out of the printer.

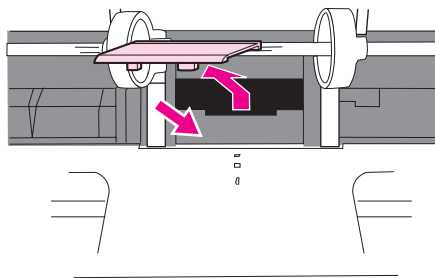

Note

If you feel resistance when you try to remove the pad, make sure that the tabs are completely separated from the printer.

13. Push the spring-loaded base down and position the new separation pad in the empty slot.

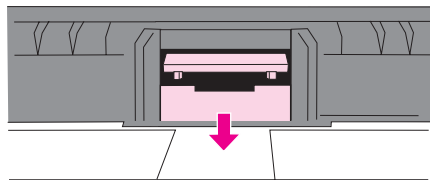

Note

Make sure that the two tabs on the edge of the pad are toward the front of the printer.

14. Snap both sides of the separation pad firmly into place until they click.

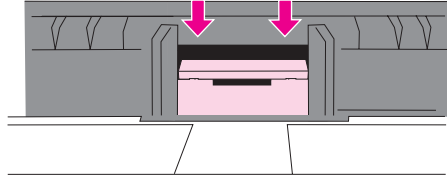

CAUTION

If the pad is not straight, or if space exists between the pad and the base, make sure that the tabs on the pad are toward the front of the printer.

15. Hold down the new separation pad. Position the new pickup roller so that the button is on the right side, and the open side of the roller faces down. Make sure that the small ridge on the open side of the roller aligns with the groove in the shaft.

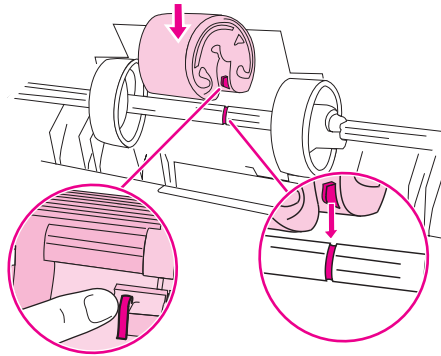

16. Slide the left and right idler rollers inward, against the pickup roller, until the idler rollers click into place.

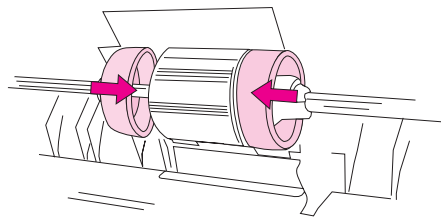

17. Hold the faceplate cover as shown in the illustration, and align the cover with the rails on the inside of the printer.

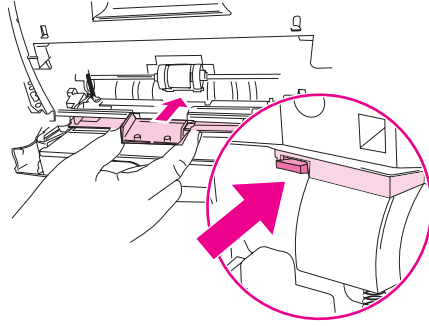

18. Grasp both sides of the center tab and insert the cover into the printer until the cover clicks into place. Close tray 1.

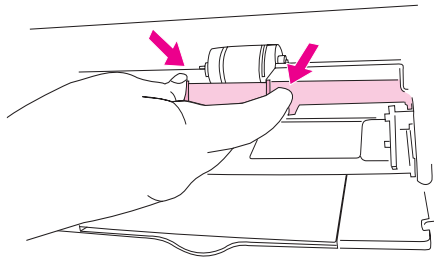

Replacing the separation pad in optional tray 2 or in optional tray 3

1. Remove the tray from the printer and place it on a flat surface. Remove any paper from the tray.

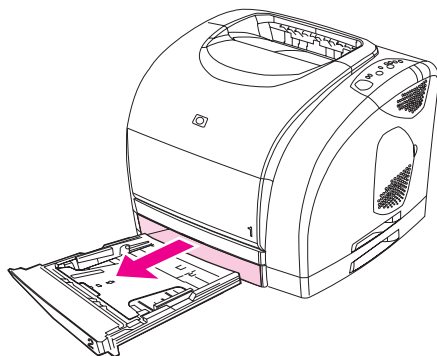

2. Locate the separation pad in the base at the inside-front edge of the tray.

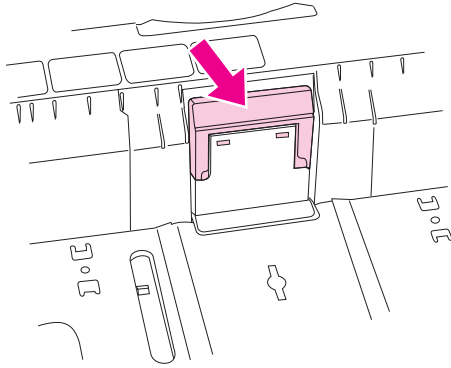

3. Press the large metal plate at the bottom of the tray down. Insert a flatblade screwdriver in the slots on each side of the base and push the tabs out of the slots.

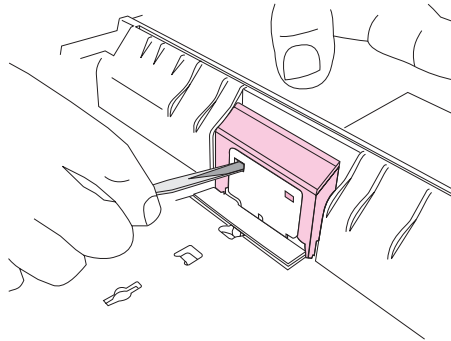

Note

In a 250-sheet tray, the plate locks down; in a 500-sheet tray, hold the plate down manually.

4. Pull the separation pad up and out of the tray.

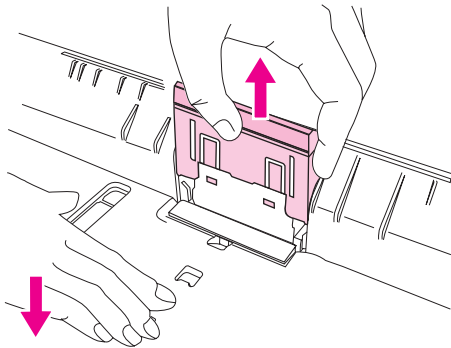

5. Use one hand to position the new separation pad above the empty base. Align the grooves on the sides of the pad with the sides of the base, and then slide the pad down until the tabs snap into the slots on the base.

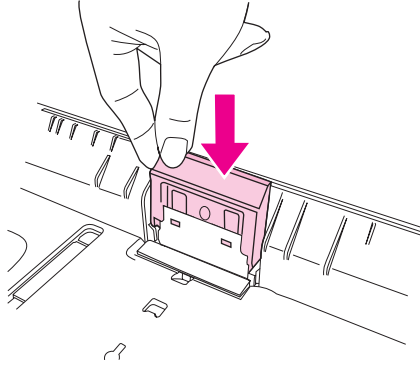

6. Reload any print media, and then slide the tray into the printer.

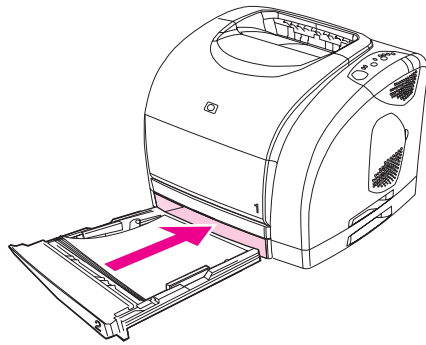

7. Reconnect the power cable. Turn the printer on.

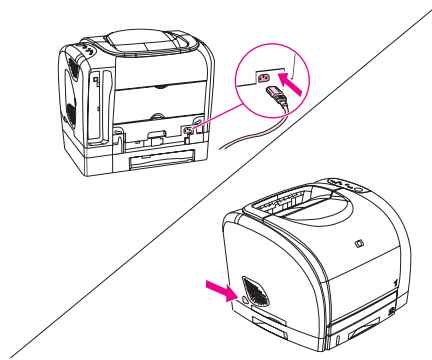

8. When the green Ready light is on, press **Go** to print a Demo page, which verifies that the printer works and that installation is complete.

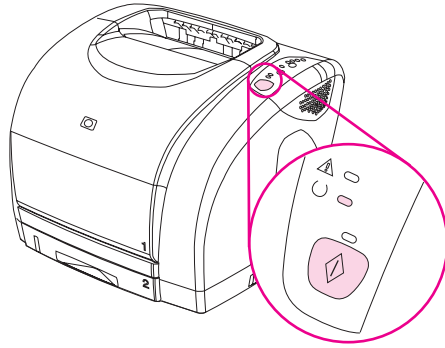

9. If the page does not print, or to find additional help, go to www.hp.com/support/clj2550.

Note

If the page does not print, reconnect the power cable. Make sure that the Ready light is on and that no other lights are on or blinking. Make sure that print media is loaded and that all parts are installed correctly.

Cleaning the printer

During the printing process, paper, toner, and dust particles can accumulate inside the printer. Over time, this buildup can cause print-quality problems such as toner specks or smearing.

Cleaning the printer

Use a cleaning page to correct and prevent print-quality problems such as toner specks or smearing.



Figure 3-1.

Smearing

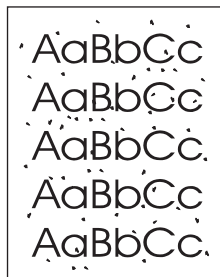

Figure 3-2.

Toner specks

To use a cleaning page

Note

The following procedure must be performed from the HP LaserJet Toolbox. To clean the printer when the computer is running an operating system that does not support the HP LaserJet Toolbox, see the Late-Breaking Readme on the CD-ROM, or visit www.hp.com/support/clj2550.

1. Make sure that the printer is turned on and in the Ready state.
2. Open the HP LaserJet Toolbox.
3. On the **Troubleshooting** tab, click **Maintenance**, click **Cleaning Page**, and then click **Print**. A page with a pattern prints from the printer.
4. At the printer, remove any print media that might be in tray 1.

5. Remove the page that printed and load it face-down into tray 1 (see [Figure 3-3. Loading the cleaning page in tray 1](#)).

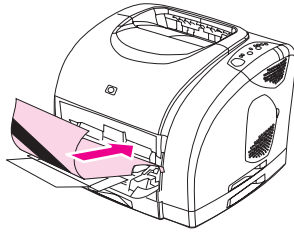

Figure 3-3. Loading the cleaning page in tray 1

6. At the computer, click **Clean**.

Calibrating the printer

The printer automatically calibrates at various times. You can adjust the calibration settings by using the HP LaserJet Toolbox.

Environmental differences, aging print cartridges, aging toner, and an aging imaging drum might cause fluctuations in image density. The printer accounts for this with image stabilization control. The printer automatically calibrates at various times to maintain the highest level of print quality. You can also request a calibration by using the HP LaserJet Toolbox.

The printer does not interrupt a print job to calibrate. It waits until the job is complete before calibrating or cleaning. While the printer is calibrating, it pauses printing for the time that is required to complete the calibration.

To calibrate the printer at the printer

Press  (Go) and  (ROTATE CAROUSELS) simultaneously to start a calibration.

To calibrate the printer from the HP LaserJet Toolbox

Note

This procedure applies to Windows operating systems only. Macintosh users should calibrate the printer manually by using the previous procedure.

1. Open the HP LaserJet Toolbox in one of these ways:
 - On the desktop, double-click the **HP LaserJet Toolbox** icon.
 - On the **Start** menu, point to **Programs**, point to **HP Color LaserJet 2550**, and then click **HP LaserJet Toolbox**.
2. On the **Troubleshooting** tab, click **Print Quality** (on the left side of the screen).
3. Click **Calibrate Now**.

Managing supplies

For warranty information about these supplies, see [Limited warranty for the print cartridges and imaging drum](#).

Supplies life

The life of the imaging drum depends on the number of black-only or color pages that print jobs require. An HP color LaserJet 2550 series printer imaging drum could last an average of 20,000 pages when printing black-only pages and 5,000 pages when printing color pages. Actual life lies somewhere between these two numbers, depending on the number of black-only pages you print versus color. The average life is between 6,000 and 8,000 pages.

Imaging-drum life is also affected each time the printer calibrates because calibrating causes the imaging drum to rotate. Imaging-drum life is measured in terms of number of rotations rather than number of pages printed.

The type and length of print jobs also affects drum life. A series of short print jobs uses more drum life than an equivalent number of pages printed in a single large job. To extend drum life, print multiple copies of a print job at one time rather than sending the same job to the printer multiple times.

The life of a print cartridge depends on the amount of toner that print jobs require. When printing text at 5% coverage, black print cartridges last an average of 5,000 pages and cyan, magenta, and yellow print cartridges last an average of 2,000 pages. Extended-life cyan, magenta, and yellow print cartridges last an average of 4,000 pages. (A typical business letter has 5% coverage.)

Note

The imaging drum and print cartridges for this printer are not compatible with older, similar printer models such as the HP color LaserJet 1500 series printer or the HP color LaserJet 2500 series printer.

For longer supplies life, you can order extended-life replacement cyan, magenta, or yellow print cartridges for the HP color LaserJet 2550L printer that last an average of 4,000 pages at 5% coverage.

Checking and ordering supplies

You can check the supplies status by using the printer control panel, printing a Supplies Status page, viewing the HP LaserJet Toolbox, or viewing HP Web Jetadmin. Hewlett-Packard recommends that you place an order for a replacement print cartridge when you first receive the Low message for a print cartridge. The Low message indicates that approximately two weeks of life remain. When you use a new, authentic HP print cartridge or imaging drum, you can obtain the following types of supplies information:



- amount of cartridge or drum life remaining
- estimated number of pages that can be printed
- number of pages printed
- other supplies information

Note

If the printer is connected to the network, you can set the HP LaserJet Toolbox to notify you by e-mail when a print cartridge is low or the imaging drum is near the end of its useful life. If the printer is directly connected to a computer, you can set the HP LaserJet Toolbox to notify you when supplies are low.

To check status and order supplies using the control panel

Do one of the following:

- Check the supplies status lights on the printer control panel. These lights indicate when a print cartridge or the imaging drum is low or empty. The lights also indicate when a non-HP print cartridge is first installed. See [Supplies Status lights](#) to interpret the light patterns.
- Press  (**Go**) and  (**Cancel Job**) simultaneously. A Supplies Status page (and the Configuration page and, possibly, the HP Jetdirect page) prints. Check the supplies levels on the Supplies Status page.

If the supplies levels are low, you can order supplies through your local HP dealer, by telephone, or online. See [Parts and diagrams](#) for part numbers. See www.hp.com/go/ljsupplies to order online.

To check status and order supplies using the HP LaserJet Toolbox

You can configure the HP LaserJet Toolbox to notify you when the supplies are low. You can choose to receive alerts by e-mail or as a pop-up message or taskbar icon. To order supplies by using the HP LaserJet Toolbox, in the **Other Links** area, click **Order supplies**.

For more information, see [Other links](#).

To check status and order supplies using HP Web Jetadmin

In HP Web Jetadmin, select the printer device. The device status page shows supplies information. To order, use the HP LaserJet Toolbox. Or, see [Parts and diagrams](#).

Storing supplies

Follow these guidelines for storing print cartridges and the imaging drum:

- Do not remove the print cartridge or imaging drum from its package until you are ready to use it.

CAUTION

To prevent damage, do not expose the print cartridge or imaging drum to light for more than a few minutes.

- See [Table 1-5. Environmental specifications](#) for operating- and storage-temperature ranges.
- Store the supply in a horizontal position.
- Store the supply in a dark, dry location away from heat and magnetic sources.

Replacing and recycling supplies

To install a new HP print cartridge or imaging drum, follow the instructions included in the box that contains the new supply, or see the *HP Color LaserJet 2550 Series Getting Started Guide*.

To recycle supplies, place the used supply in the box in which the new supply arrived. Use the enclosed return label to send the used supply to HP for recycling. For complete information, see the recycling guide that is included with each new HP supply item. See [HP Printing Supplies Returns and Recycling Program information](#) for more information about HP's recycling program.

HP policy for non-HP supplies

Hewlett-Packard Company cannot recommend the use of non-HP supplies, either new or remanufactured. Because they are not HP products, HP cannot influence their design or control their quality. Service or repairs that are required as a result of using a non-HP supply will *not* be covered under the printer warranty.

When you insert a supply into the printer, the printer informs you if the supply is not a genuine HP supply. If you insert a genuine HP supply that has reached the low state from another HP printer, the printer identifies the supply as non-HP. Simply return the supply to the original printer to reactivate HP features and functionality.

Resetting the printer for non-HP supplies

When you install a non-HP print cartridge or imaging drum, the light next to the print cartridge or imaging drum you replaced blinks and the Attention light is on. In order to print with this supply, you must press  (**Cancel Job**) the first time you install this non-HP supply. The status lights will not indicate when this type of supply is low or empty.

CAUTION

The printer will not stop printing when a non-HP supply is empty. Printer damage can occur if the printer attempts to print with an empty print cartridge or imaging drum. See [Uninstalling the printing software](#).

HP fraud hotline

Call the HP fraud hotline if the supplies status lights indicate that the print cartridge or imaging drum is not an HP product and you think that it is genuine. Hewlett-Packard will help determine if the product is genuine and take steps to resolve the problem.

Your print cartridge or imaging drum might not be a genuine HP product if you notice the following issues:

- You are experiencing a large number of problems with the print cartridge or imaging drum.
- The print cartridge or imaging drum does not look like an HP product usually does (for example, the pull tab or the box is different).

In the United States, call toll-free: 877-219-3183.

Outside the United States, you can call collect. Dial the operator and ask to place a collect call to this telephone number: 770-263-4745. If you do not speak English, a representative at the HP fraud hotline who speaks your language will assist you. Or, if someone who speaks your language is not available, a language line interpreter will connect approximately one minute after the beginning of the call. The language line interpreter is a service that translates between you and the representative for the HP fraud hotline.

4

Theory of operation

Chapter contents

Chapter contents	67
Introduction	68
Engine control system	70
Basic sequence of operation	70
Power-on sequence	72
Motors and fans	73
Laser/scanner system	74
Pickup and feed system	75
Paper trays	76
Jam detection	77
Photosensors and switches	78
Solenoid and clutches	80
Printed circuit assemblies	82
Image-formation system	84
Image-formation process	85
Latent-image-formation stage	85
Developing stage	86
Transfer stage	87
Fusing stage	89
Print cartridge	93
Imaging-drum E-label	94

Introduction

This chapter presents an overview of the relationships between major components in the printer, and includes a detailed discussion of the image-formation system. The following systems are discussed:

- engine control system
- laser/scanner system
- pickup and feed system
- image-formation system

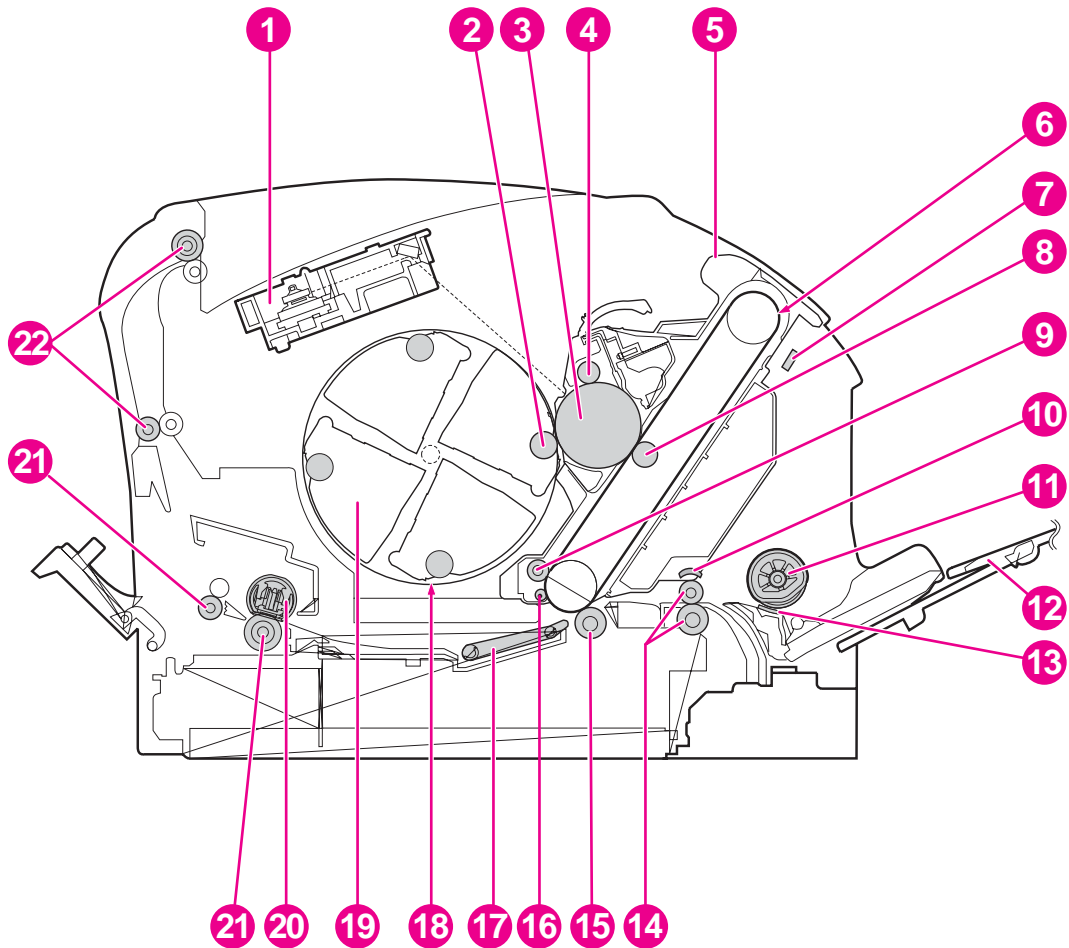

Figure 4-1. Cross-section of the printer

Ref	Description	Part number	Qty
1	Laser/scanner	RG5-6880-000CN	
2	Developing cylinder	(contained in print cartridge)	
3	Photosensitive drum	(contained in imaging drum)	
4	Primary charging roller	(contained in imaging drum)	
5	Imaging drum	Q3964A	

Ref	Description	Part number	Qty
6	Transfer belt	(contained in imaging drum)	
7	Density sensor	RH7-7146-000CN	
8	Primary transfer roller	(contained in imaging drum)	
9	Transfer-belt cleaning roller	(contained in imaging drum)	
10	Registration shutter	(contained in imaging drum)	
11	Pickup roller	RG5-6592-000CN	
12	Tray 1	RG5-7585-000CN	
13	Separation pad	RF5-4012-000CN	
14	Registration roller	RG5-6939-000CN	
15	Secondary transfer roller	RF5-4067-000CN	
16	Auxiliary transfer-belt cleaning roller	(contained in imaging drum)	
17	Feed belt (8)	RB3-0063-000CN	
18	Carousel	RG5-7592-000CN	
19	Print cartridge	(several; see Table 7-2. Accessories for part numbers)	
20	Fusing film	(contained in fuser)	
21	Pressure roller	(contained in fuser)	
22	Fuser delivery roller	(contained in fuser)	
23	Top output bin delivery roller	RG5-7595-000CN (lower) and RG5-6897-000CN (upper)	

Engine control system

The engine control system coordinates all printer functions. It drives the laser/scanner system, the image formation system, and the pickup and feed system.

The engine control system contains the following components:

- Dc controller
- High-voltage power-supply PCB
- Low-voltage power unit:
 - Fuser-control circuit
 - Low-voltage power-supply PCB

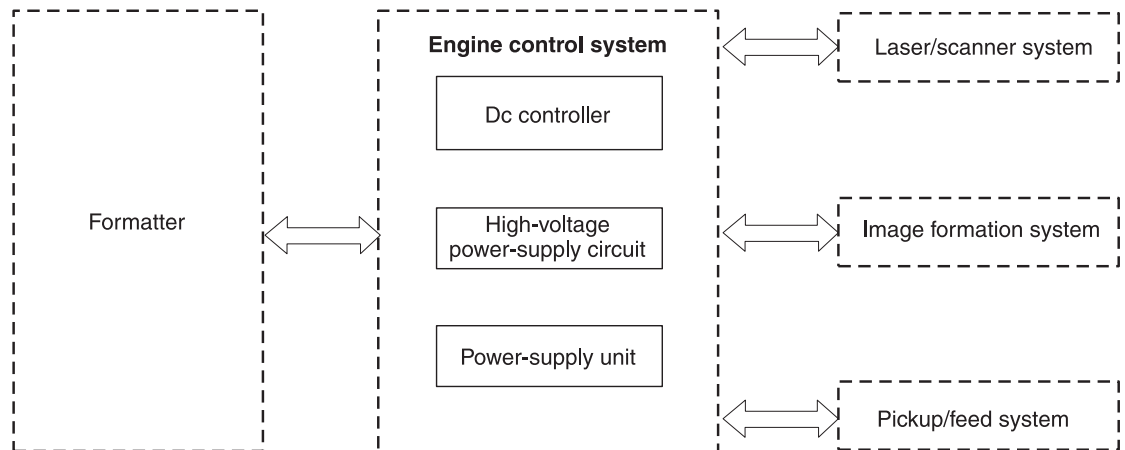

Figure 4-2. Engine control system (includes the basic configuration of the printer)

Basic sequence of operation

Operation sequences are controlled by the CPU in the dc controller in the engine control system. [Table 4-1. Basic sequence of operation](#) describes engine operations for each period of a print operation.

Table 4-1. Basic sequence of operation

Period	Duration	Purpose	Remarks
WAIT (wait)	From the time the power switch is turned on until transfer-belt cleaning is complete.	Clears potential from the drum surface and cleans the transfer belt.	See Figure 4-3. Power-on sequence for a complete description of the WAIT (power-on) period. Also see the General timing charts for detailed information about timing.
STBY (standby)	From the end of the WAIT or LSTR period until either a print command is sent from the formatter or the power is turned off.	Prepares the printer to receive print commands.	

Table 4-1. Basic sequence of operation (continued)

Period	Duration	Purpose	Remarks
INTR (initial rotation)	From the time of the print command until detection of the HP1 (transfer-belt home-position detection) signal for the first color.	Prepares the photosensitive drum for printing.	
PRINT (print)	From the end of the INTR period until detection of the transfer-belt home-position signal for the secondary transfer.	Forms the image on the photosensitive drum and transfers the toner image to the transfer belt.	
LSTR (last rotation)	From the end of the PRINT period until the main motor stops rotating.	Transfers the toner image on the transfer belt to the media and delivers the printed media.	After LSTR, the printer returns to STBY.

Power-on sequence

The power-on sequence is represented by the flowchart in [Figure 4-3. Power-on sequence.](#)

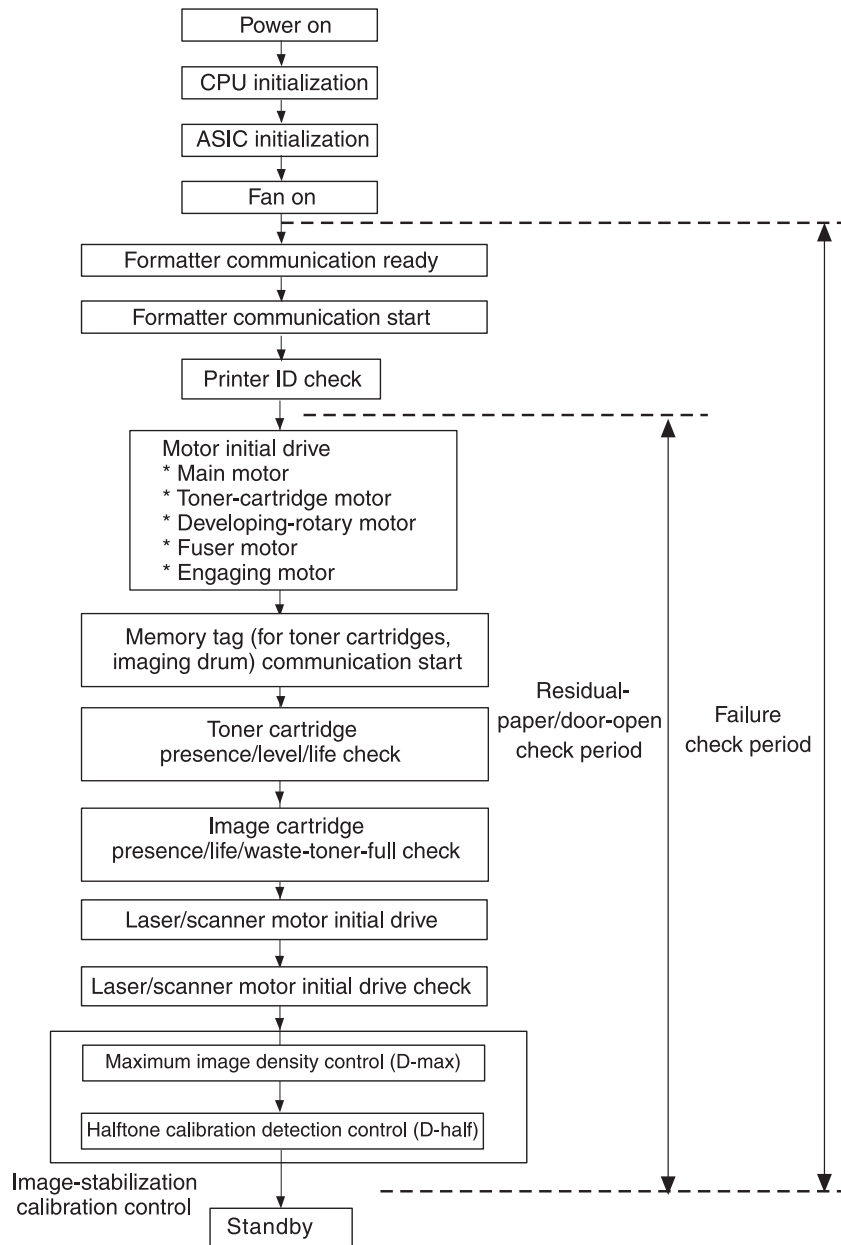

Figure 4-3.

Power-on sequence

Motors and fans

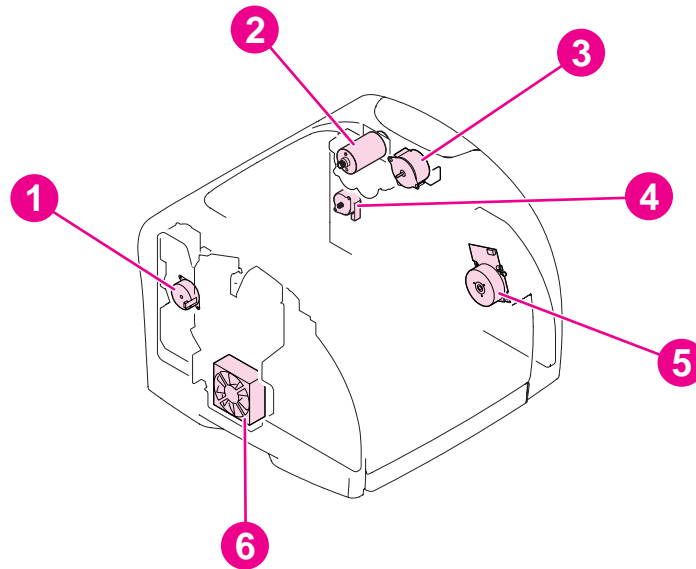

Figure 4-4.

Motors and fans

Table 4-2. Motors and fans

Reference	Description
1	Engaging motor
2	Developing-rotary motor
3	Toner-cartridge motor
4	Fuser motor
5	Main motor
6	Cooling fan

Laser/scanner system

The laser/scanner system receives video signals from the dc controller, and then it converts the signals into latent images on the photosensitive drum. The dc controller controls the laser/scanner.

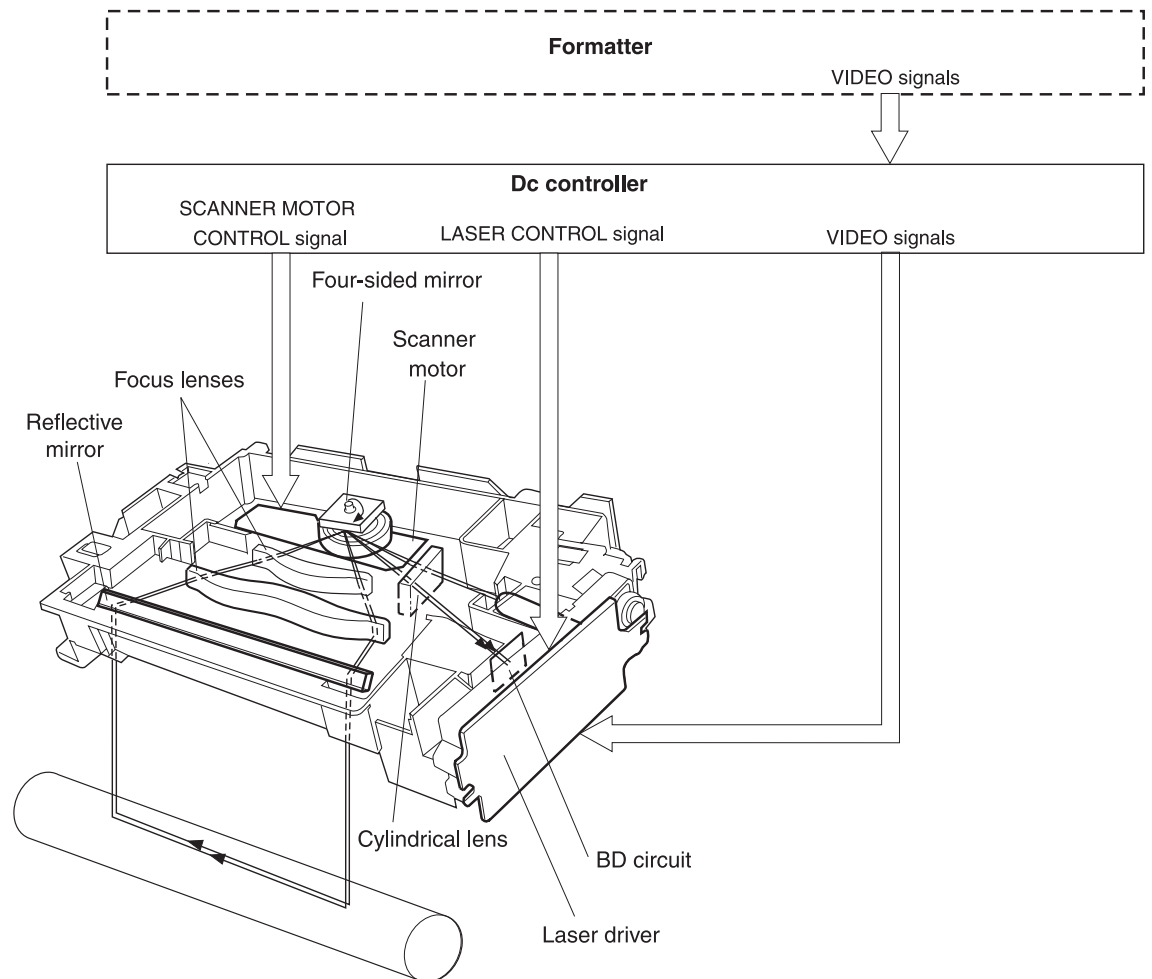

Figure 4-5. Laser/scanner system

Pickup and feed system

The pickup and feed system consists of several types of feed rollers and sensors. The dc controller drives the paper and feed system by controlling two motors, two clutches, and the solenoid.

Two photo-interrupters (PS1 and PS711) detect media as it passes. If media does not reach or pass each sensor within the specified time period, the dc controller determines that a jam has occurred and alerts the video controller circuit.

The following components are identified in [Figure 4-6. Pickup and feed system](#):

- **PS1** fusing-delivery paper sensor
- **PS711** registration paper sensor
- **PS718** tray 1 (multipurpose tray) paper sensor
- **PS720** fuser wrap-jam sensor
- **DCM701** main motor
- **PM702** fuser motor
- **SL92** tray 1 pickup solenoid

- CL1 registration clutch
- CL2 roller-engaging clutch

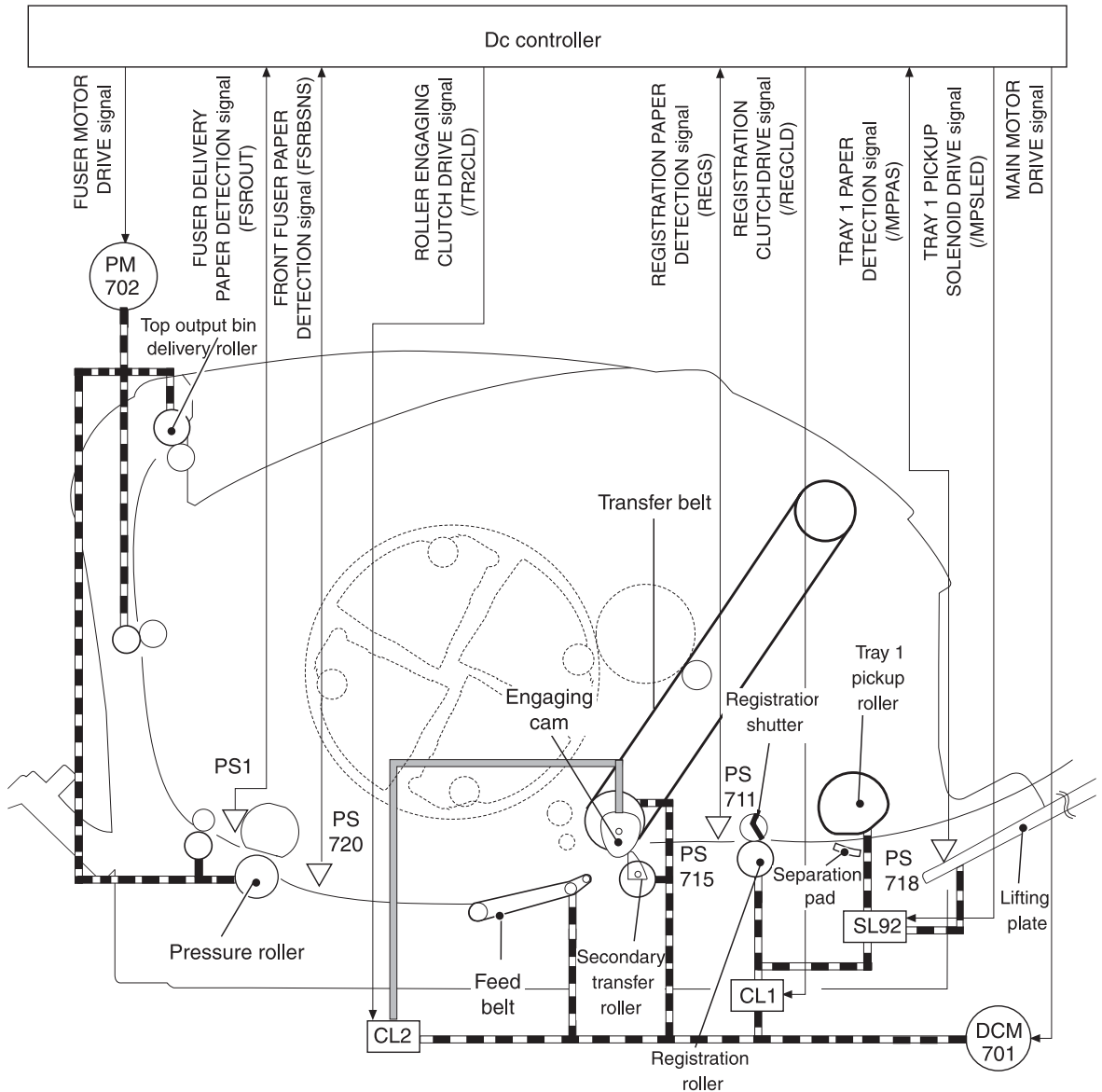

Figure 4-6. Pickup and feed system

Paper trays

The dc controller drives the operation sequence of the paper trays. It signals the driver PCB in optional tray 2 (250-sheet paper tray) and in optional tray 3 (500-sheet paper tray). In optional tray 2, the printer main motor drives the tray solenoids. In optional tray 3, each driver PCB controls the motors and solenoids in its paper tray.

The following components are identified in [Figure 4-7. Optional tray 2 \(250-sheet paper tray\)](#):

- DCM701 gear-train motor (printer)
- SL9 pickup solenoid (optional tray 2)

- **PS716** paper sensor (optional tray 2)
- **PS717** paper-feed sensor

Note

Only optional tray 2 is shown; optional tray 3 is similar.

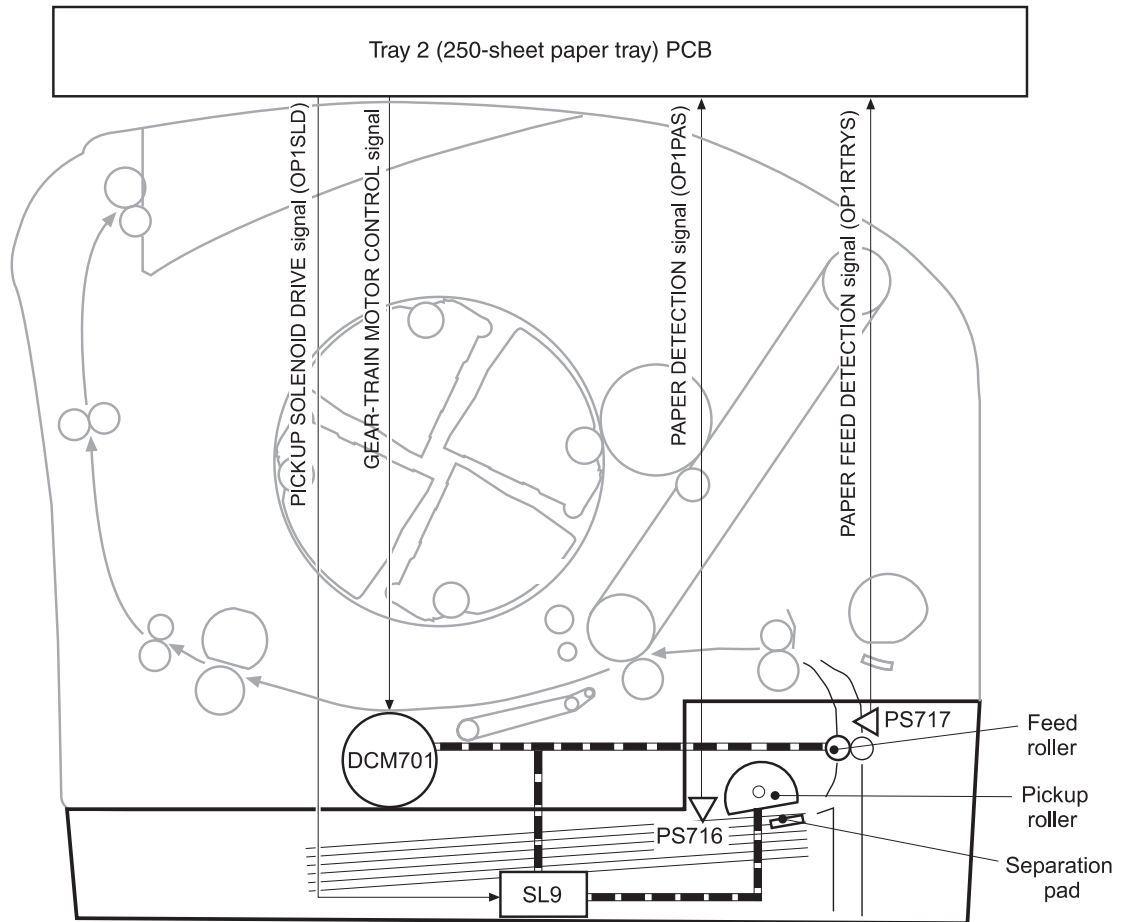

Figure 4-7. Optional tray 2 (250-sheet paper tray)

Jam detection

The registration sensor (PS711) and the fuser sensor (PS1) detect media that is moving through the printer. If a jam is detected, the dc controller immediately stops the printing process and sends a message to the video controller circuit.

A jam can be detected under any of the following conditions:

- Pickup delay jam. The leading edge of the print media does not reach the registration sensor (PS711) within 1.1 seconds (tray 1), 1.7 seconds (optional tray 2), or 2.8 seconds (optional tray 3).
- Pickup stationary jam. The registration clutch is on, and the registration sensor (PS711) does not detect the trailing edge of the media within 3.4 seconds after the start of a re-pickup operation.
- Fuser wrap-jam. The main CPU detects media inside the fuser front sensor (PS720) when the power is turned on or after the top cover is closed.

- Delivery delay jam. The registration clutch is on, and the fuser-delivery sensor (PS1) does not detect the leading edge of the media within 2.3 seconds after the start of a re-pickup operation.
- Delivery stationary jam. The leading edge of media does not pass the fuser-delivery sensor (PS1) within 2.4 seconds after it has passed the registration sensor (PS711).
- Door-open jam. The main CPU detects that the top cover is open during a print operation.
- Residual jam. The main CPU detects one or more of the following conditions:
 - Power is turned on.
 - The printer door is closed after a jam occurrence.
 - The registration sensor (PS711) and fusing-delivery sensor (PS1) detect media.
- Paper pickup failure. The sensor (PS717) near the feed roller does not detect media moving through the printer.

Photosensors and switches

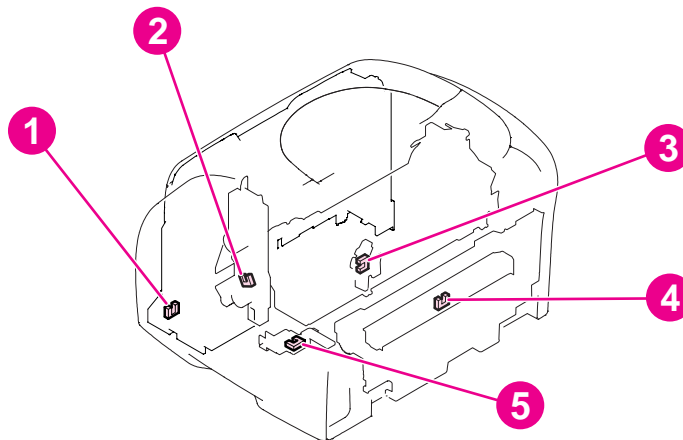

Figure 4-8. Photosensors and switches (1 of 2)

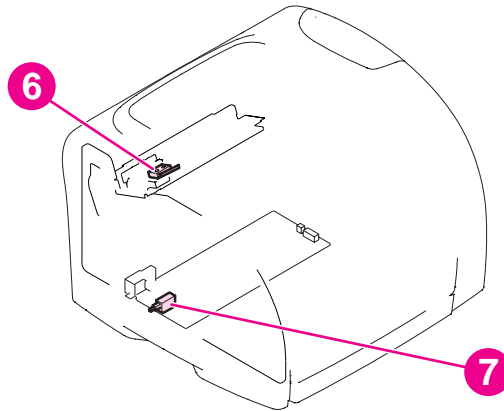

Figure 4-9. Photosensors and switches (2 of 2)

Table 4-3. Photosensors and switches

Reference	Description
1	Tray 1 sensor
2	Roller-engaging sensor
3	Developing-rotary-engaging sensor
4	Fuser-delivery sensor
5	Front fuser-detection sensor
6	Door-open detection switch
7	Power switch

Solenoid and clutches

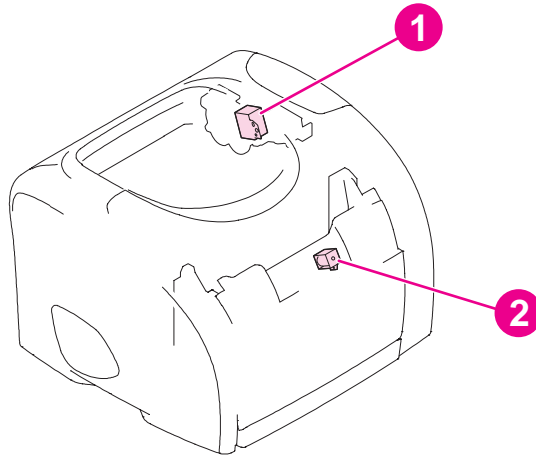

Figure 4-10.

Solenoid

Table 4-4. Solenoid

Reference	Description
1	Developing-rotary-stopper solenoid
2	Tray 1 pickup solenoid

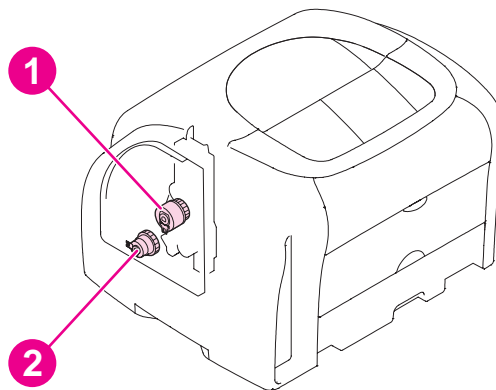

Figure 4-11. Clutches

Table 4-5. Clutches

Reference	Description
1	Roller-engaging clutch
2	Registration clutch

Printed circuit assemblies

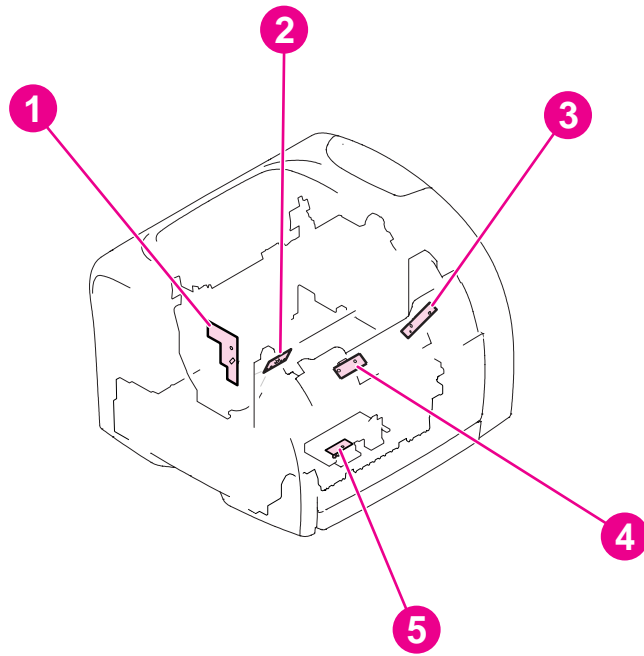

Figure 4-12. Printed circuit assemblies (1 of 2)

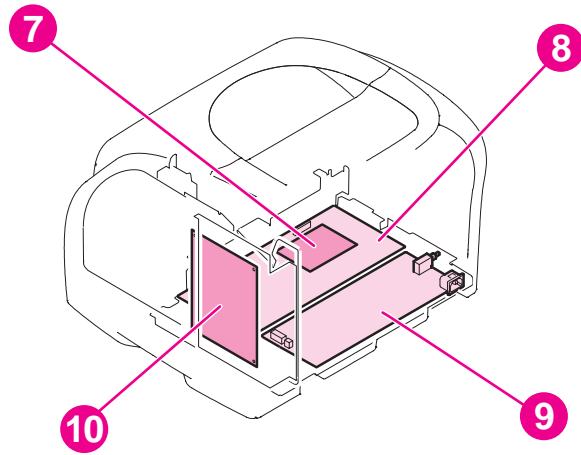

Figure 4-13. Printed circuit assemblies (2 of 2)

Table 4-6. Printed circuit assemblies

Reference	Description
1	Developing-rotary/toner-level detection PCA
2	Transfer-belt home-position detection PCA
3	Waste-toner-detection PCA
4	Density-detection PCA
5	Registration-detection PCA
6	Dc controller
7	Sub high-voltage power-supply PCA
8	High-voltage power-supply PCA
9	Power supply

Image-formation system

The image-formation system, which forms a toner image on media, consists of several interdependent systems:

- Electrostatic latent-image-formation system
- Developing system
- Transfer block
- Fuser
- Transfer belt cleaning block
- Imaging drum (with ITB)
- Photosensitive drum

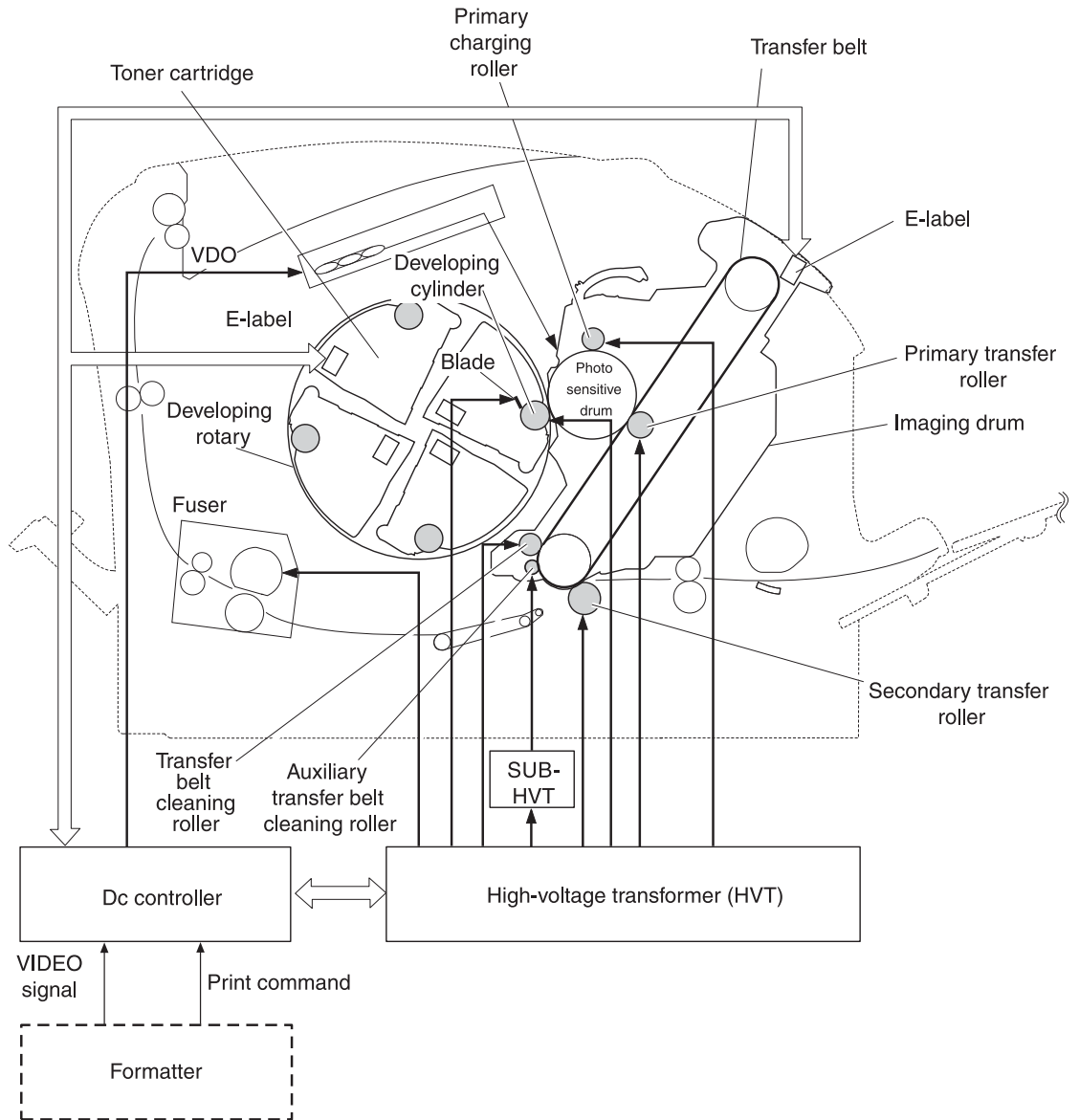

Figure 4-14. Image-formation system

Image-formation process

Laser printing requires the interaction of several different technologies including electronics, optics, and electrophotographics to produce a printed page. Each process functions independently and must be coordinated with the other printer processes. Image formation consists of the following five processes:

1. Latent-image formation
2. Developing
3. Image transfer
4. Fusing
5. Transfer-belt cleaning

The five processes are divided into twelve steps, which are shown in the Image-formation process graphic and are described in the following sections.

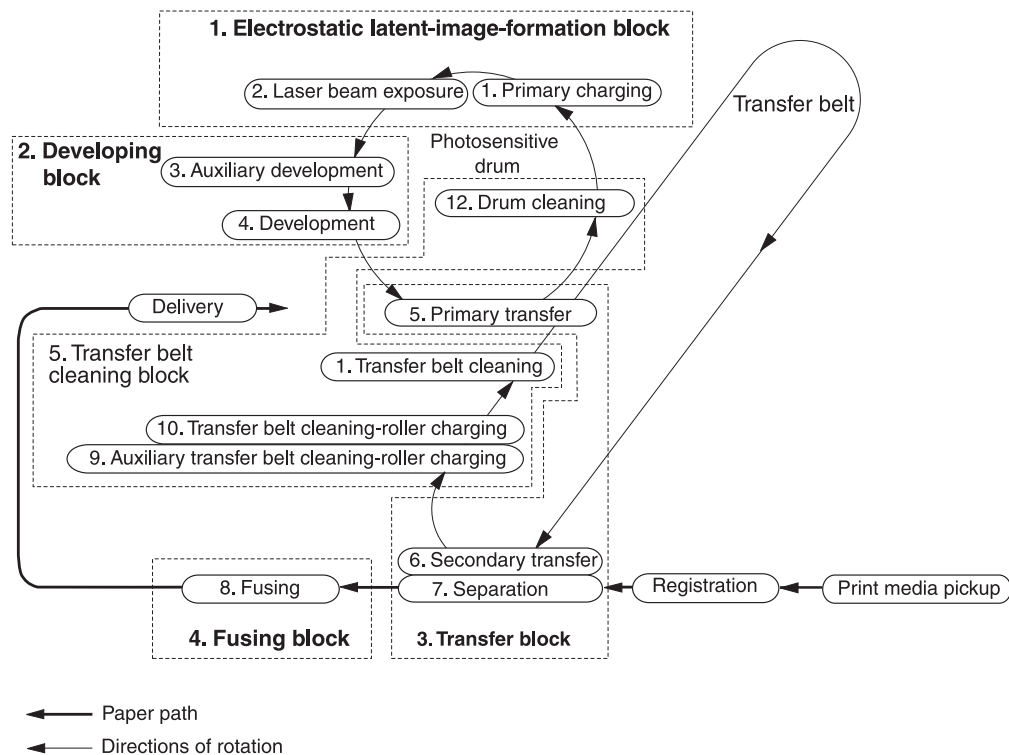

Figure 4-15. Image-formation process

Latent-image-formation stage

Step 1: primary charging

A dc bias is applied to the primary charging roller, which transfers a uniform negative potential to the photosensitive drum.

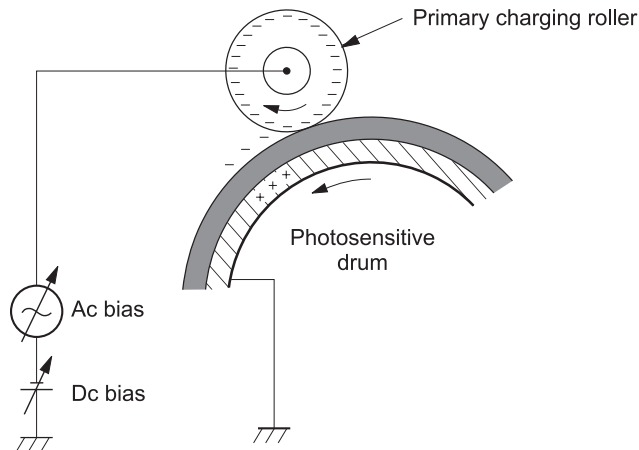

Figure 4-16.

Step 1: primary charging

Step 2: laser-beam exposure

The laser beam scans the photosensitive drum to neutralize negative charges on parts of the drum. An electrostatic latent image is formed on the drum where negative charges were neutralized.

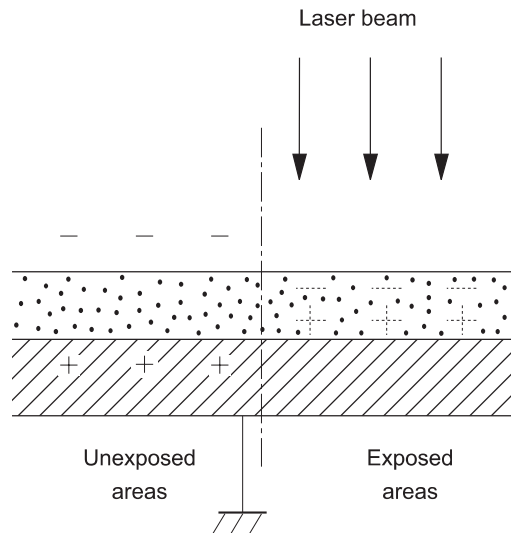

Figure 4-17.

Step 2: laser-beam exposure

Developing stage

The developing cylinder comes in contact with the photosensitive drum to deposit toner onto the electrostatic latent image.

Note

The charges on the exposed area on the drum are shown as positive in [Figure 4-18. Developing block](#). The charges are actually negative, but they are more positive than the charges on the developing cylinder.

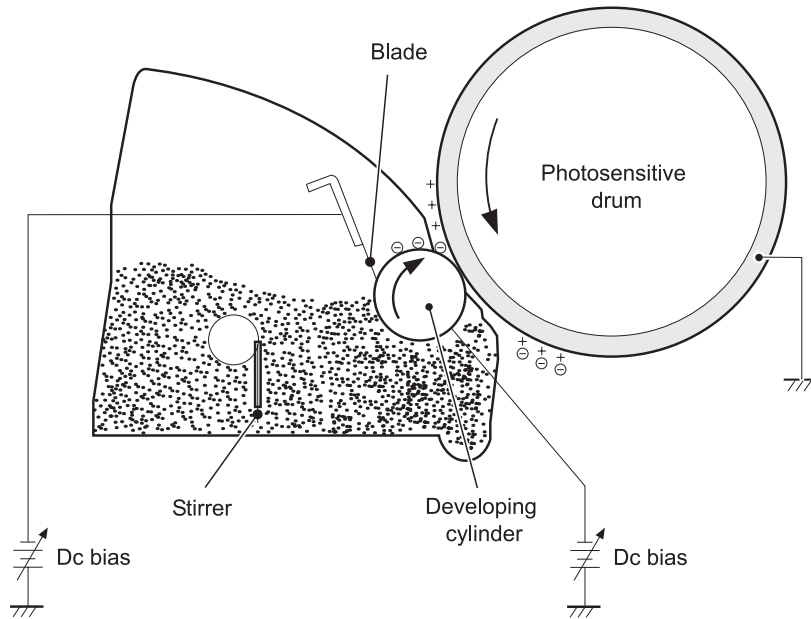

Figure 4-18. Developing block

Step 3: auxiliary developing

The dc bias applied to the blade imports a uniform negative potential to the toner.

Step 4: developing

Toner acquires a negative charge through friction from the developing cylinder and the blade. When the negatively charged toner comes in contact with the drum, the toner adheres to the electrostatic latent image. The image on the drum becomes visible because of the toner.

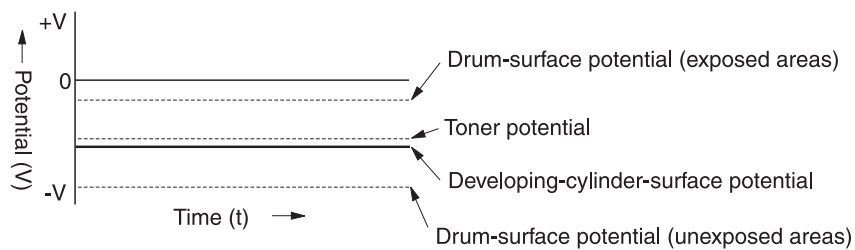

Figure 4-19. Step 3: developing

Transfer stage

Step 5: primary transfer

The primary transfer roller, to which a dc positive bias is applied, imparts a positive charge on the transfer belt. The negatively charged toner on the drum is transferred to the positively charged transfer belt. This procedure is repeated for each color (yellow, magenta, cyan, and black).

The dc positive bias is increased for each successive color to make sure that all of the colors adhere to the transfer belt.

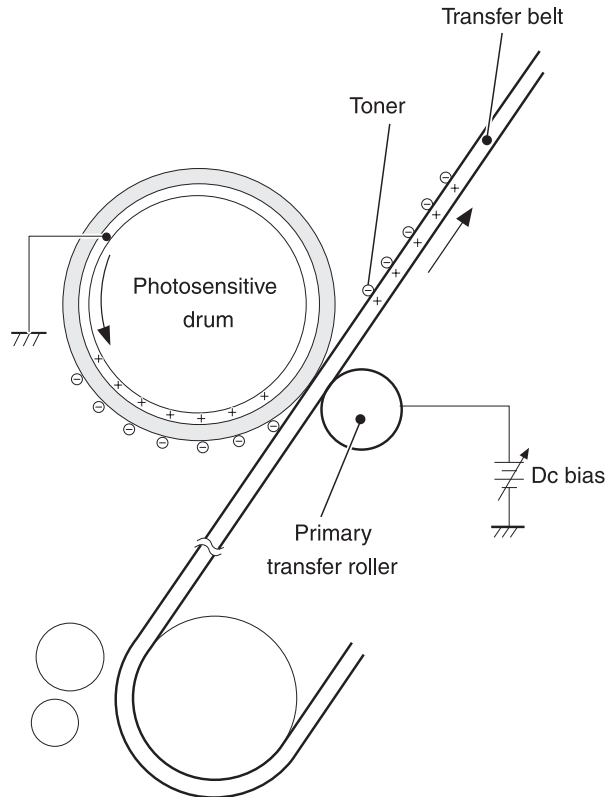

Figure 4-20.

Step 4: primary transfer

Step 6: secondary transfer

The secondary transfer roller, to which a dc positive bias is applied, imparts a positive charge to the print media. When the print media comes in contact with the transfer belt, the toner is transferred to the print media.

Note

When secondary transfer is complete, a dc negative bias is applied to the secondary transfer roller to prevent toner on the transfer belt from adhering to the secondary transfer roller.

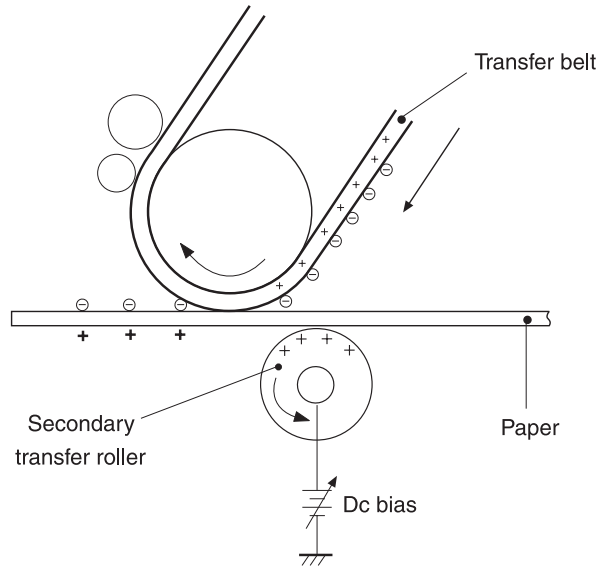

Figure 4-21. Step 5: secondary transfer

Step 7: separation

The elasticity of the print media causes it to separate from the transfer belt. A static charge eliminator aids separation by weakening any electrostatic adhesion.

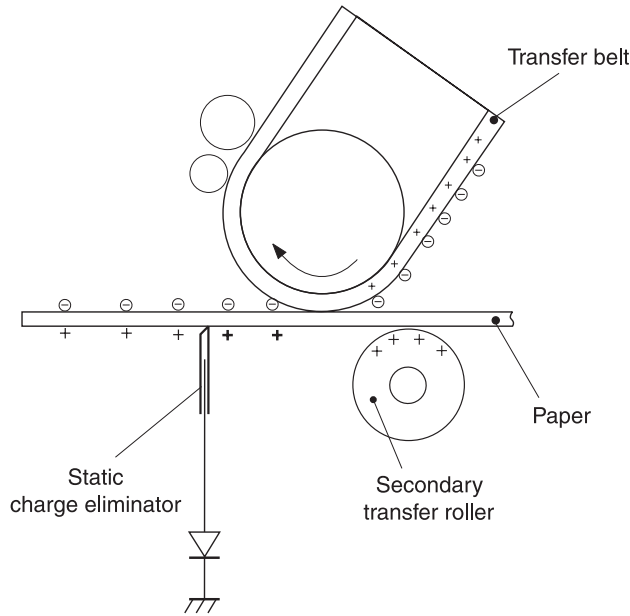

Figure 4-22. Step 6: separation

Fusing stage

The heat of the fuser bonds the toner to the media.

Step 8: fusing

The dc negative bias applied to the fusing film strengthens the holding force of the toner on the print media and prevents the toner from scattering.

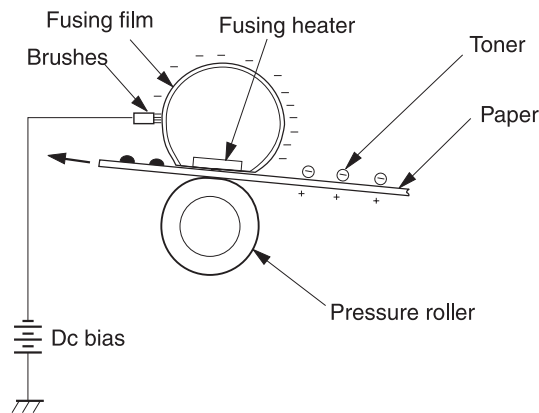

Figure 4-23.

Step 7: fusing

Step 9: roller charging (auxiliary transfer belt cleaning roller)

During secondary transfer, not all of the toner on the transfer belt is transferred to the print media. Toner that remains on the belt is called "residual toner."

The auxiliary transfer belt cleaning roller, to which a dc positive bias is applied, imparts a positive charge to the residual toner, strengthening its hold on the transfer belt. This prevents toner from falling off of the transfer belt and scattering in the printer.

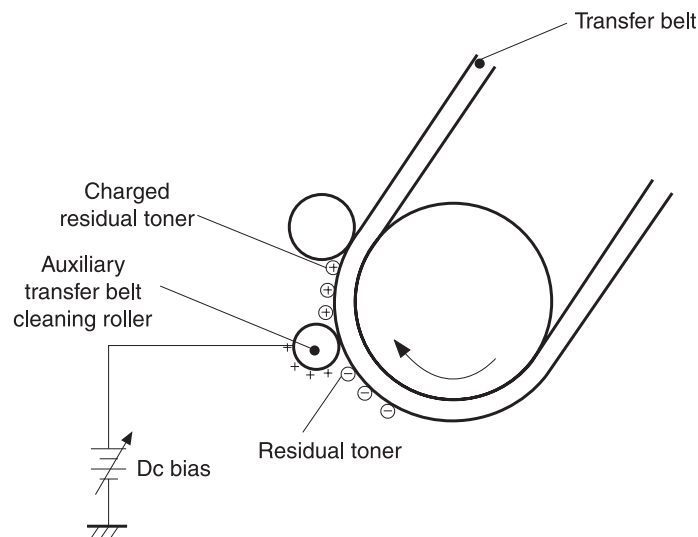

Figure 4-24.

Step 8: roller charging (auxiliary transfer belt cleaning roller)

Step 10: roller charging (transfer-belt cleaning roller)

The transfer-belt cleaning roller, to which a dc positive bias is applied, imparts a positive charge to the residual toner on the transfer belt. This positive charge is stronger than the positive charge applied in step 8, so the earlier charge now behaves like a negative charge.

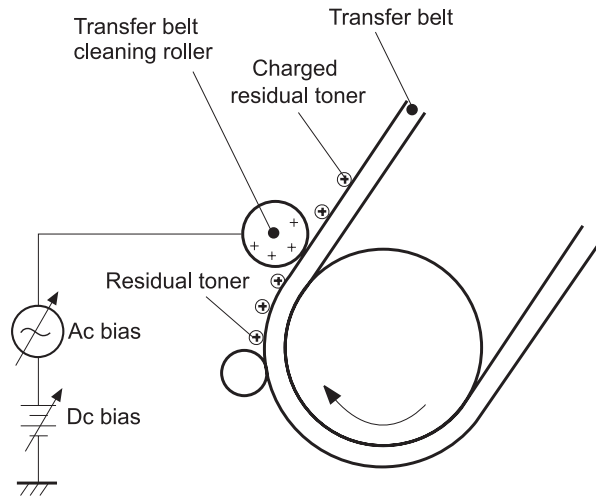

Figure 4-25.

Step 9: roller charging (transfer belt cleaning roller)

Step 11: transfer belt cleaning

A dc positive bias is applied to the transfer belt to produce a difference in potential between the belt and the photosensitive drum. This causes residual toner to transfer to the drum.

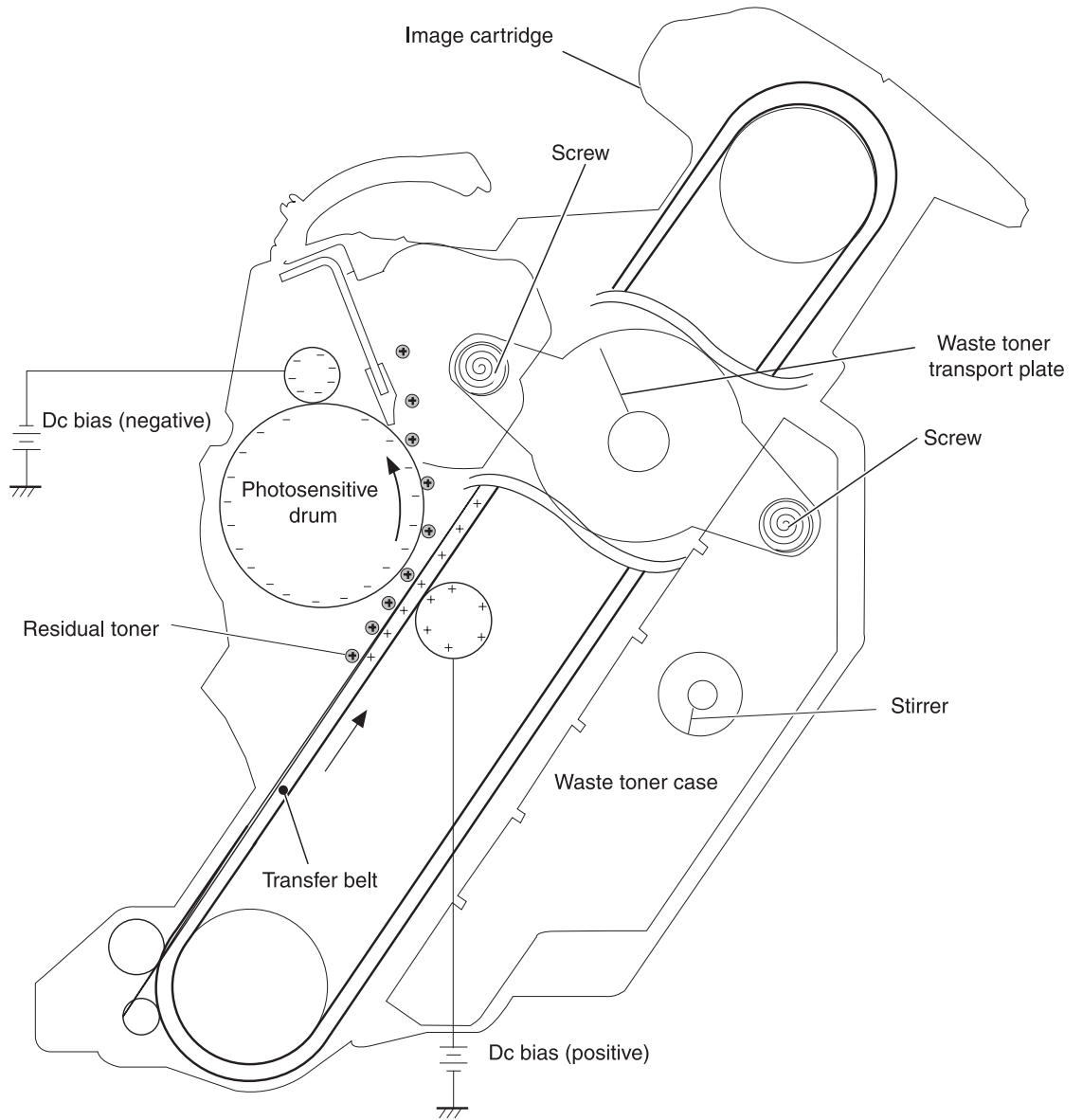

Figure 4-26. Step 10: transfer belt cleaning

Step 12: drum cleaning

The cleaning blade scrapes the residual toner off of the photosensitive drum, where the waste toner screws collect the toner and deposit it into the waste toner case.

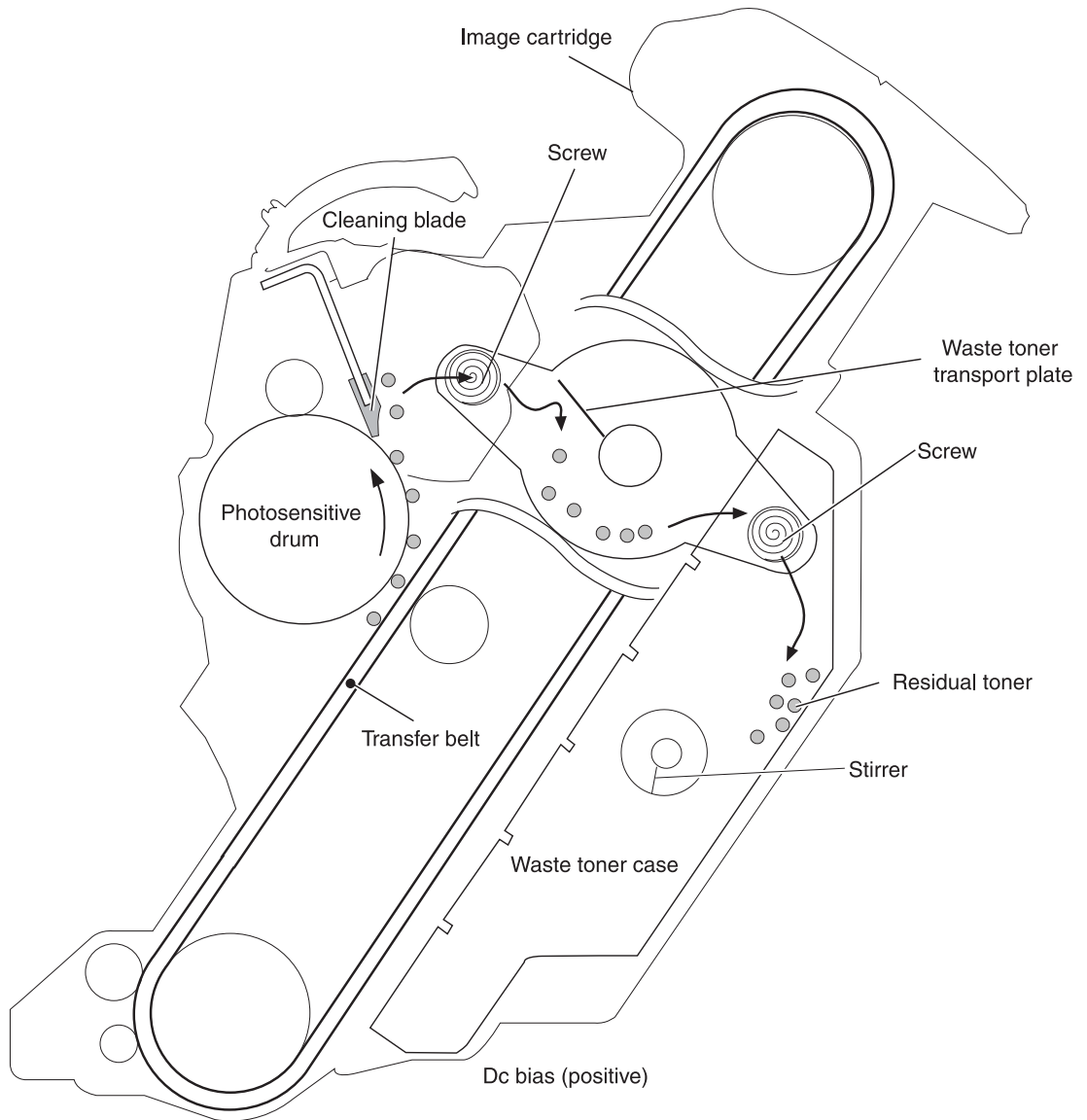

Figure 4-27.

Step 11: drum cleaning

Print cartridge

The printer has four print cartridges: yellow, magenta, cyan, and black. Each print cartridge contains a developing cylinder, toner-feed roller, and stirrer. The developer motor rotates these parts so that each print cartridge can use toner to form a visible image on the drum.

The carousel motor rotates the E-label reader, which communicates E-label information to the dc controller.

The developing rotary/toner level detection PCB uses an LED (light emitter) and a photodiode (light receiver) to determine the toner level in each print cartridge.

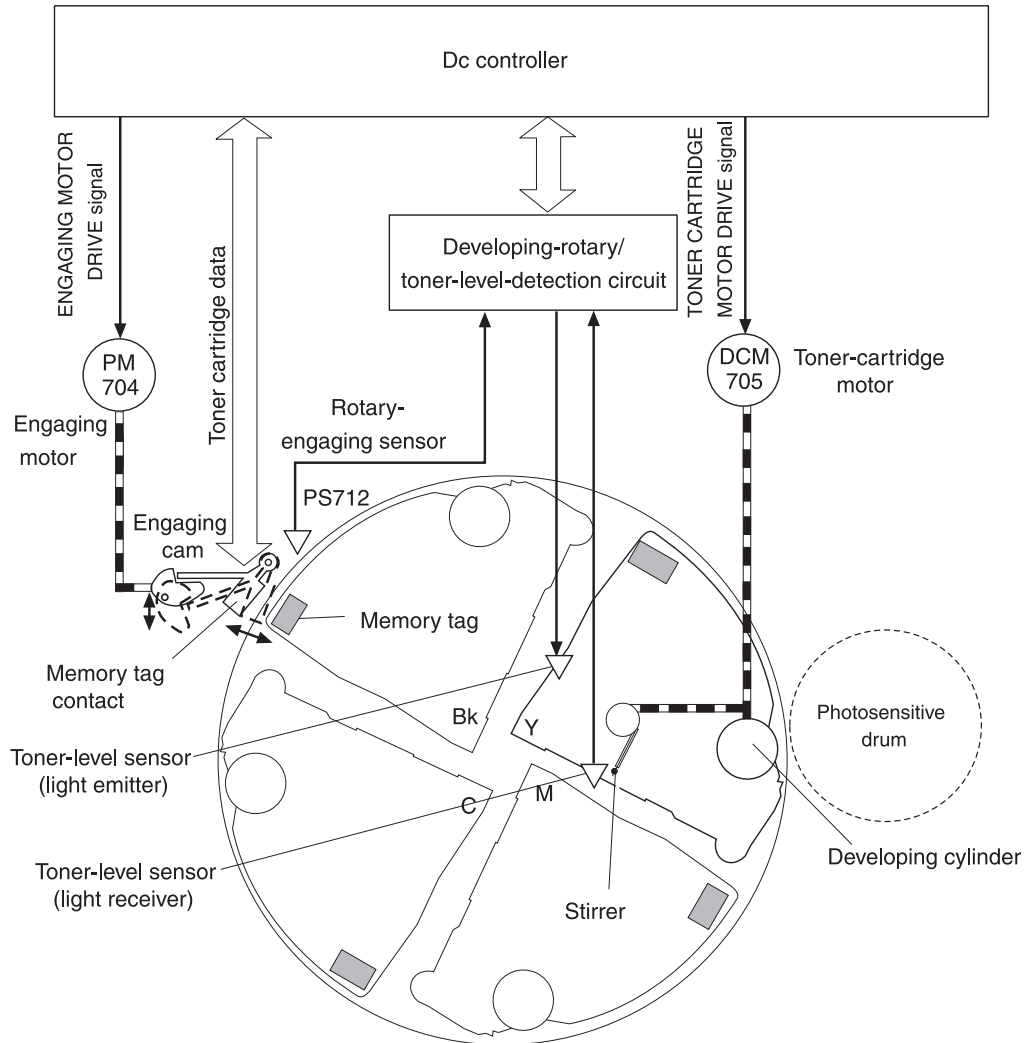

Figure 4-28. Print cartridge

Imaging-drum E-label

The E-label is nonvolatile memory, which is built into the imaging drum and stores usage information. When the imaging drum is installed in the printer, the E-label makes constant contact with the E-label reader. The E-label reader sends memory information to the dc controller, which updates the information and sends it back to the E-label.

The dc controller instructs the E-label to read information when:

- The printer is turned on.
- The top cover is closed.
- A command is sent from the video controller.

The dc controller instructs the E-label to write information when:

- A specified period occurs during printing.
- A command is sent from the video controller.

If the E-label reader fails to read or write information four times in a row, the dc controller notifies the video controller that an abnormality exists in the imaging drum.

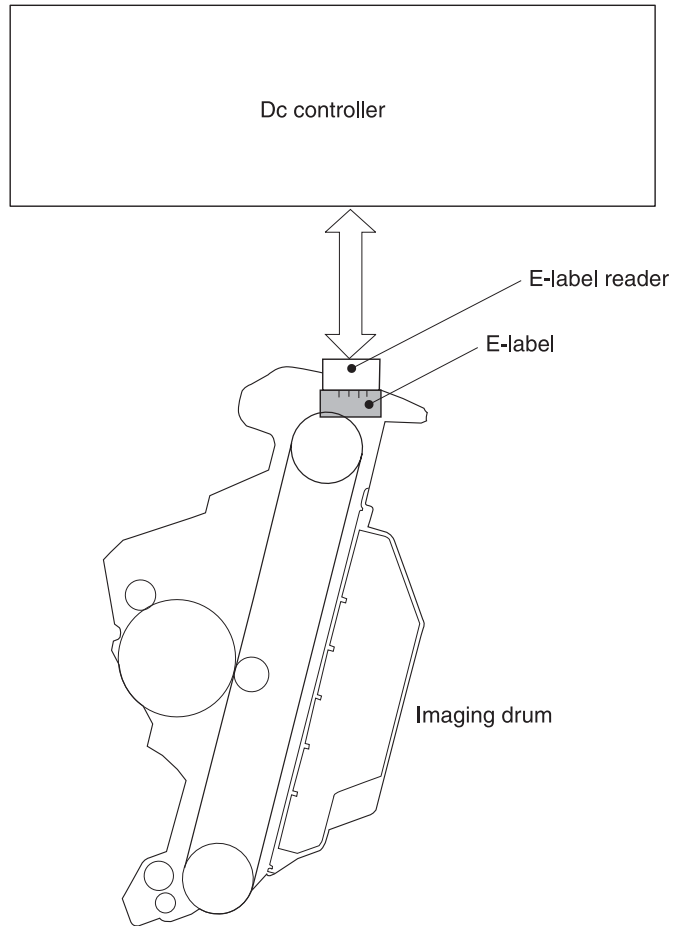

Figure 4-29. Print-cartridge E-label

5

Removal and replacement

Chapter contents

Chapter contents	97
Introduction	99
Removal and replacement strategy	99
Electrostatic discharge	99
User-replaceable parts	99
Required tools	99
Before performing service	101
Pre-service procedures	101
Parts removal order	102
Removal and replacement	103
Imaging drum	103
Print cartridges	103
Fuser cover (and fuser)	104
Right- and left-side covers	106
Control panel	107
On-off switch	109
Interface cover	110
Formatter assemblies	111
Fuser motor	116
Dc controller	117
Optional tray 2 (250-sheet tray)	118
Carousel-engagement motor	120
Front lower cover	121
Back cover	122
Top cover	123
Top door	125
Air duct and fan	127
Laser/scanner assembly	128
Front cover	130
Density sensor and top-of-page sensor	130
E-label reader (for imaging-drum E-labels)	132
Tray 1 (multipurpose tray)	133
Tray 1 separation pad assembly	135
Gear assembly	136
Waste-toner sensor	138
Rotary-drive assembly	139
Top plate	142
Print-cartridge carousel	145
Aligning the carousel gears	149
Registration-roller assembly	150

Toner-catch tray	151
Transfer-roller plate	152
Transfer roller	152
Feed-drive shaft	153
ECU pan	154
Sub-high-voltage transformer PCA	157
High-voltage transformer PCA	158
Low-voltage PCA	159
Paper-top sensor	160
Fuser-wrap sensor	161
250-sheet feeder pickup roller	162
500-sheet feeder pickup roller	163

Introduction

This chapter documents removal and replacement of field replaceable units (FRUs) only.

Removal and replacement strategy

Replace parts in the reverse order of their removal. Directions for difficult or critical replacement procedures are included.

WARNING!

The sheet-metal edges of the product can be sharp. Use caution when working on the product.

Note

Note the length, diameter, color, type, and location of each screw. Be sure to return each screw to its original location during reassembly.

Incorrectly routed or loose wire harnesses can interfere with other internal components and can become damaged or broken. Frayed or pinched harness wires can be difficult to locate. When replacing wire harnesses, always use the provided wire loops, lance points, or wire-harness guides.

Electrostatic discharge

CAUTION

The product contains parts that are sensitive to electrostatic discharge (ESD). Always service the product at an ESD-protected workstation, or use an ESD mat.

Watch for the ESD symbol (shown at left) to identify the parts that are sensitive to ESD. Protect these parts by using an ESD wrist strap and by placing ESD-sensitive parts into protective ESD pouches.



User-replaceable parts

This chapter contains removal and replacement procedures for the imaging drum (see [Imaging drum](#)) and the print cartridge (see [Print cartridges](#)).

To remove and replace the pickup roller or separation pad, see [Replacing the tray 1 pickup roller and separation pad](#).

Required tools

The following tools are needed to service this product:

- #2 Phillips screwdriver with magnetic tip
- Small flatblade screwdriver
- Small needle-nose pliers

- ESD mat
- Penlight

CAUTION

A PoziDriv screwdriver will damage screw heads on the product. Use a #2 Phillips screwdriver.

If you use a multispeed screwdriver, use a torque limiter.

Before performing service

Follow the pre-service procedures before you perform service.

Pre-service procedures

1. Remove all media from the product.
2. Place the product on an ESD mat. If an ESD mat or an ESD-protected workstation is not available, discharge body static and ground the product chassis before servicing the product.
3. Remove the imaging drum (see [Imaging drum](#)).
4. Remove the print cartridges (see [Print cartridges](#)).
5. Unplug the power cord and the interface cable.
6. Lift the printer (and optional tray 2) off of optional tray 3 (if it is installed).

Parts removal order

Use the following diagram to determine which parts must be removed before removing other parts.

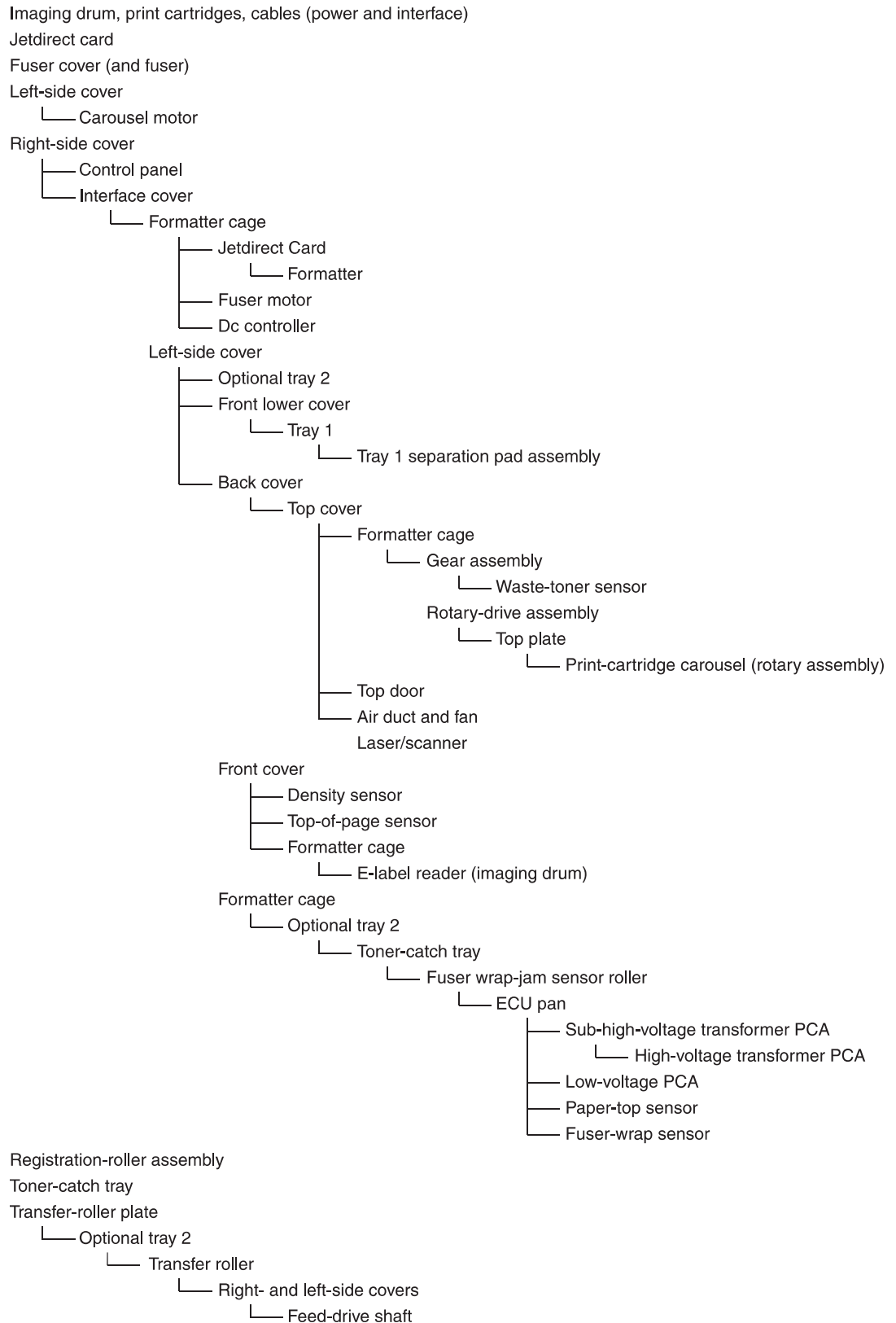

Removal and replacement

Imaging drum

1. Open the top cover.

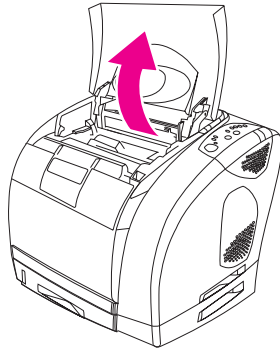

2. Grasp the imaging drum handle and then rotate the imaging drum until the handle is horizontal.
3. Lift the imaging drum straight up to remove it from the printer.

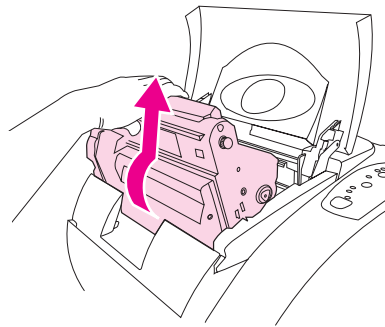

Print cartridges

1. Open the top door.

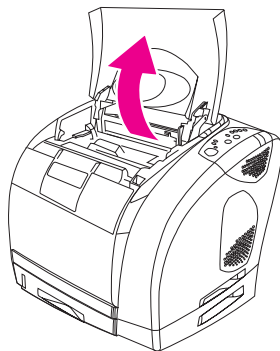

2. Remove the imaging drum (see [Imaging drum](#)).

3. Pinch together the two large blue tabs on the first cartridge and then lift the cartridge straight up to remove it from the carousel.

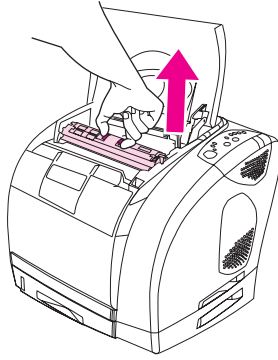

4. Close the top cover, and then press the **Rotate Carousel** button.

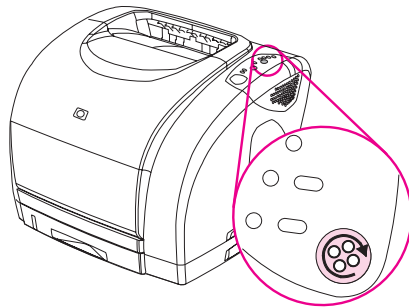

Note

If the print-cartridge carousel does not rotate, see [Functional checks](#).

5. Open the top cover, and then remove the next cartridge following the procedure in step 3.
6. Repeat steps 2 through 5 until all four cartridges have been removed.

Note

When the top door is open, the carousel retracts but does not rotate.

Fuser cover (and fuser)

1. Turn the printer off.
2. Rotate two locking tabs (callout 1) upward.

3. Gently slide the fuser out of the printer.

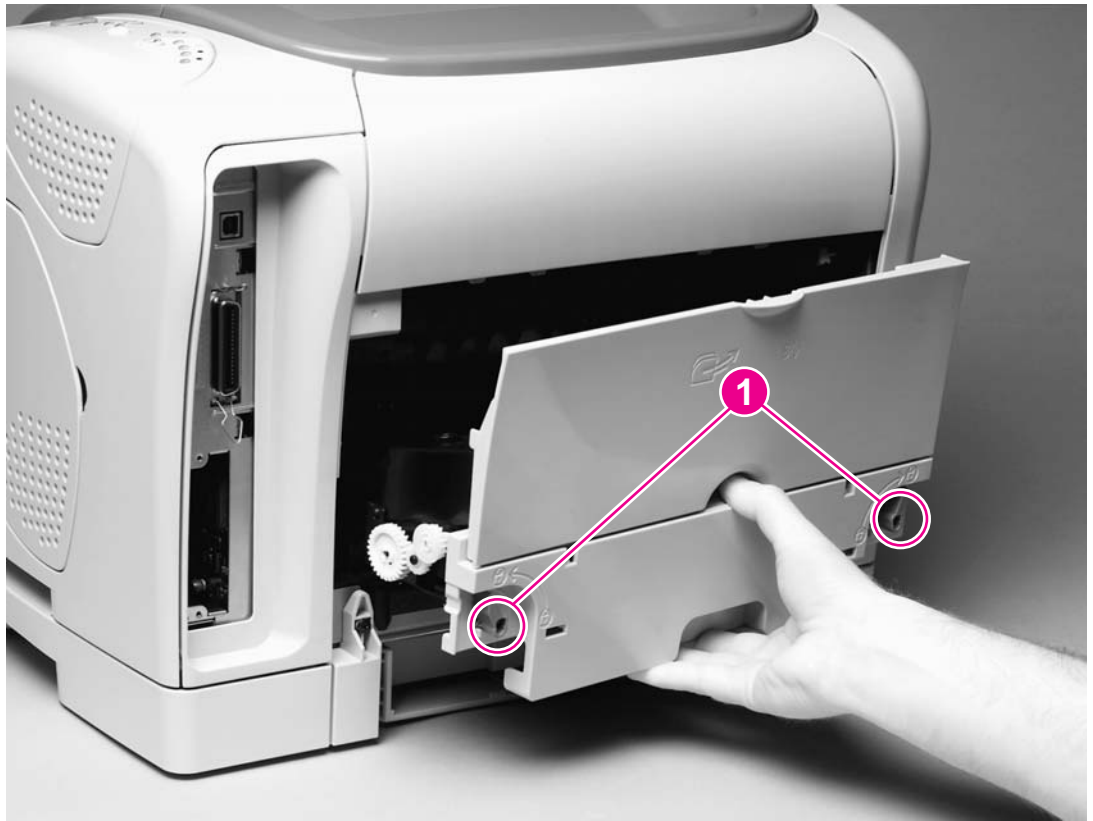

Figure 5-1. Removing the fuser cover (and fuser)

Right- and left-side covers

Use the following steps to remove the right-side cover. Then, remove the left-side cover in the same manner.

1. Remove one screw (callout 1) from the lower edge of the cover.

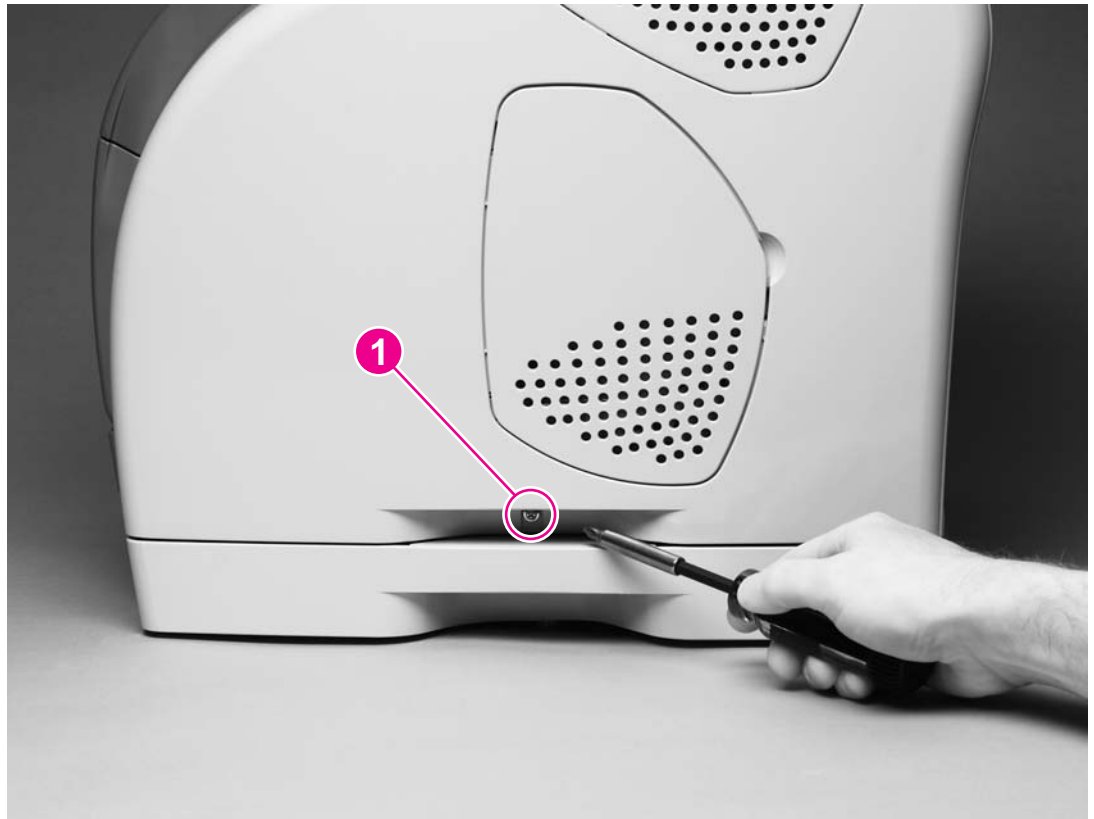

Figure 5-2. Removing the right-side cover (1 of 2)

2. Grasp the cover by the handle and by the top and then pull the cover out gently, rotating the cover away from the printer as you lift it straight up.

CAUTION

To avoid breaking two internal tabs (see detail in [Figure 5-3. Removing the right-side cover \(2 of 2\)](#)), lift the cover straight up.

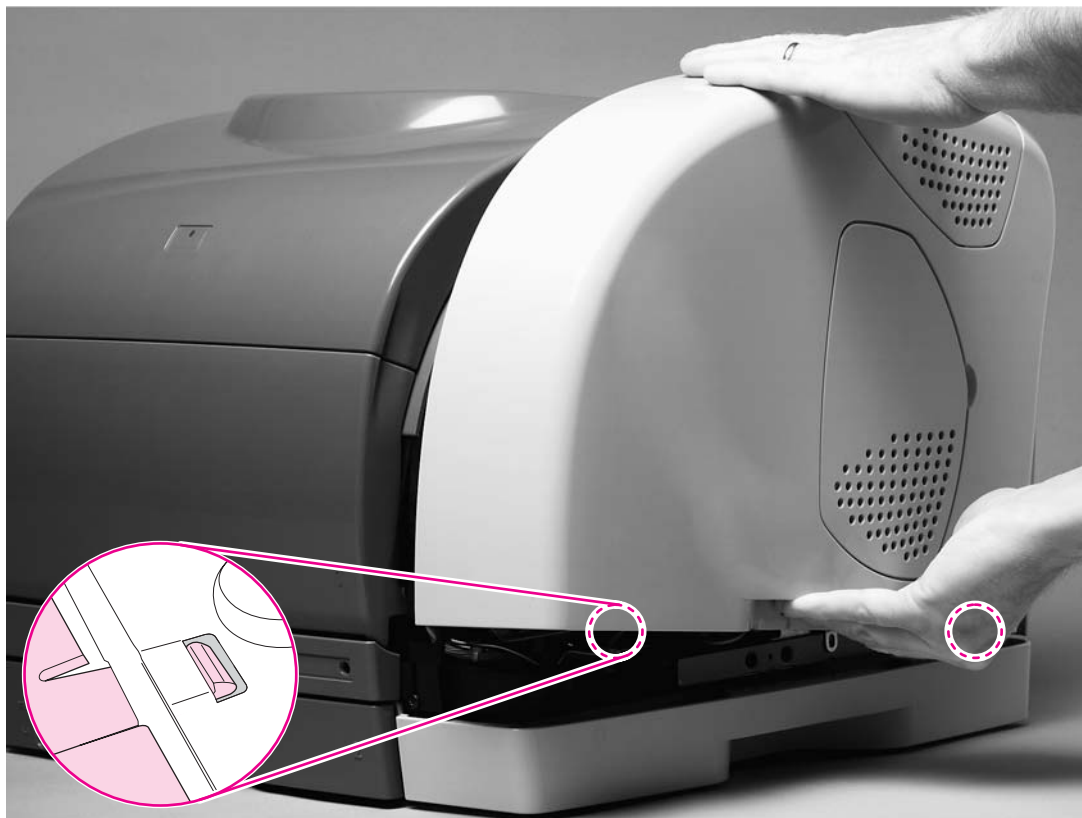

Figure 5-3. Removing the right-side cover (2 of 2)

3. Repeat steps 1 and 2 to remove the left-side cover.

Reinstallation tip

Reattach the tab that is closer to the front of the printer before reattaching the back tab.

Control panel

1. Remove the right-side cover (see [Right- and left-side covers](#)).

2. Use a flatblade screwdriver to lift the plastic catch (callout 1) off of the tab.

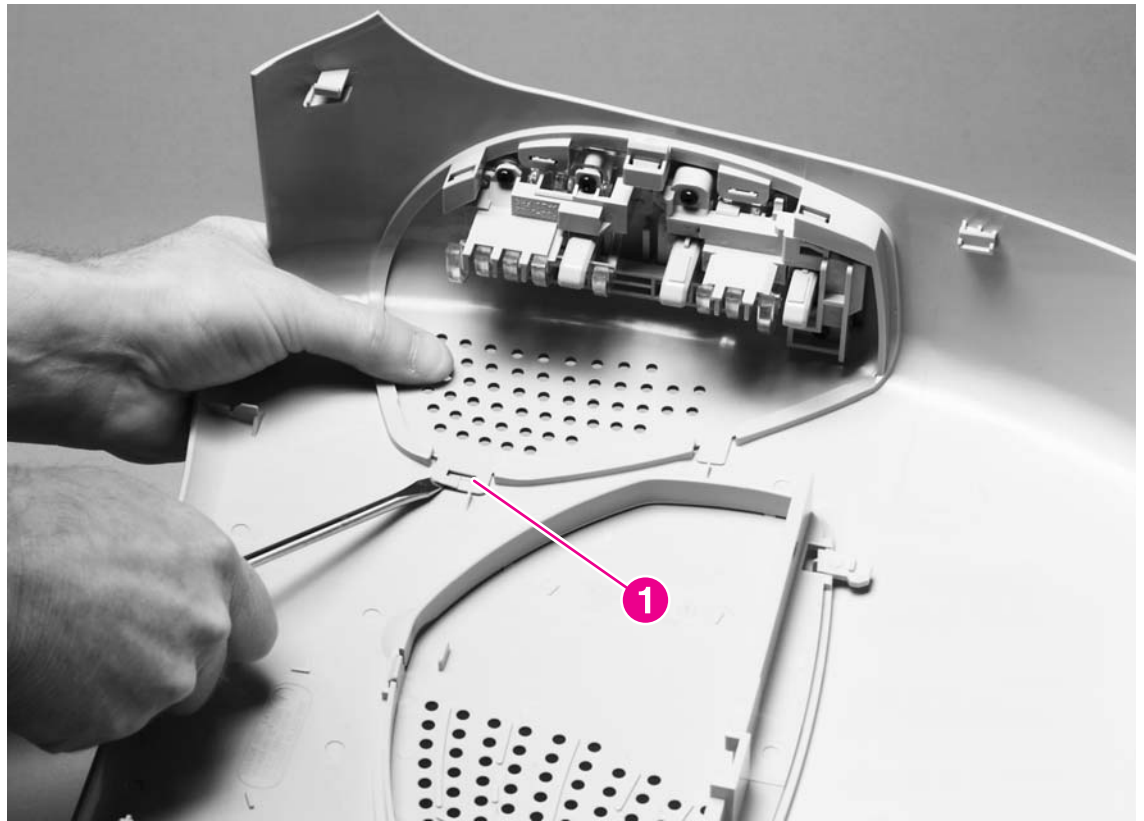

Figure 5-4. Removing the control panel (1 of 2)

3. Push the control panel away from the right-side cover to release three tabs (callout 2), and then continue pushing the control panel to remove it.

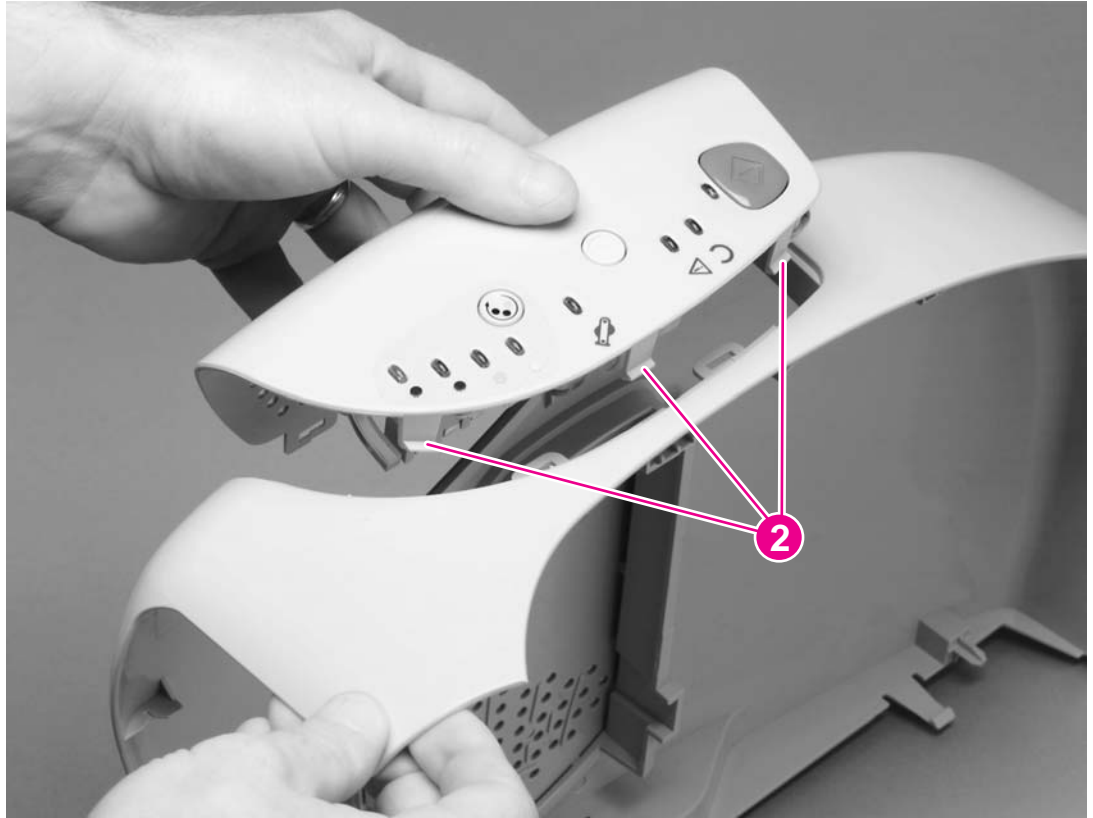

Figure 5-5. Removing the control panel (2 of 2)

On-off switch

1. Remove the left-side cover (see [Right- and left-side covers](#)).
2. On the inside of the left-side cover, pinch two tabs (callout 1) together to remove the spring (callout 2).

3. Pinch the two tabs together, and then press them through the holes in the left-side cover to release the on-off switch.

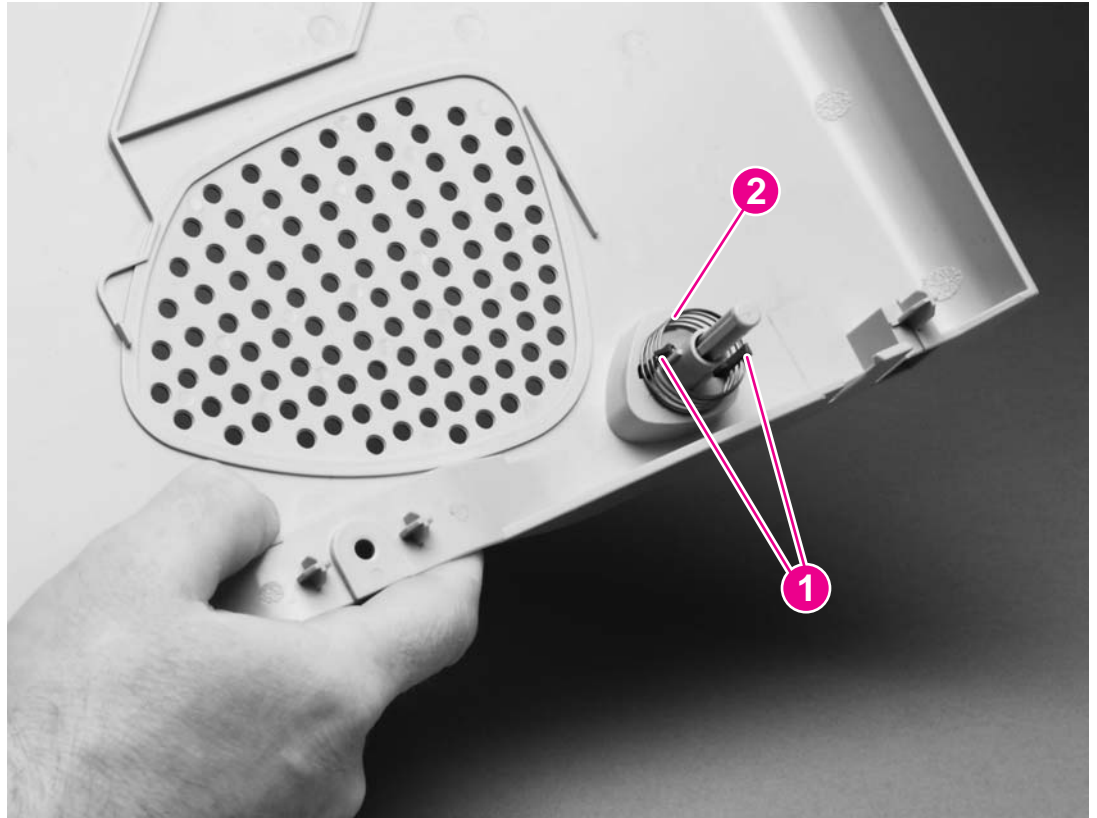

Figure 5-6. Removing the on-off switch

Interface cover

1. Remove the fuser (see [Fuser cover \(and fuser\)](#)).
2. Release the tab (callout 1) at the top of the interface cover and the tab (callout 2) at the back cover.

3. Rotate the top of the interface cover away from the printer to remove the cover.

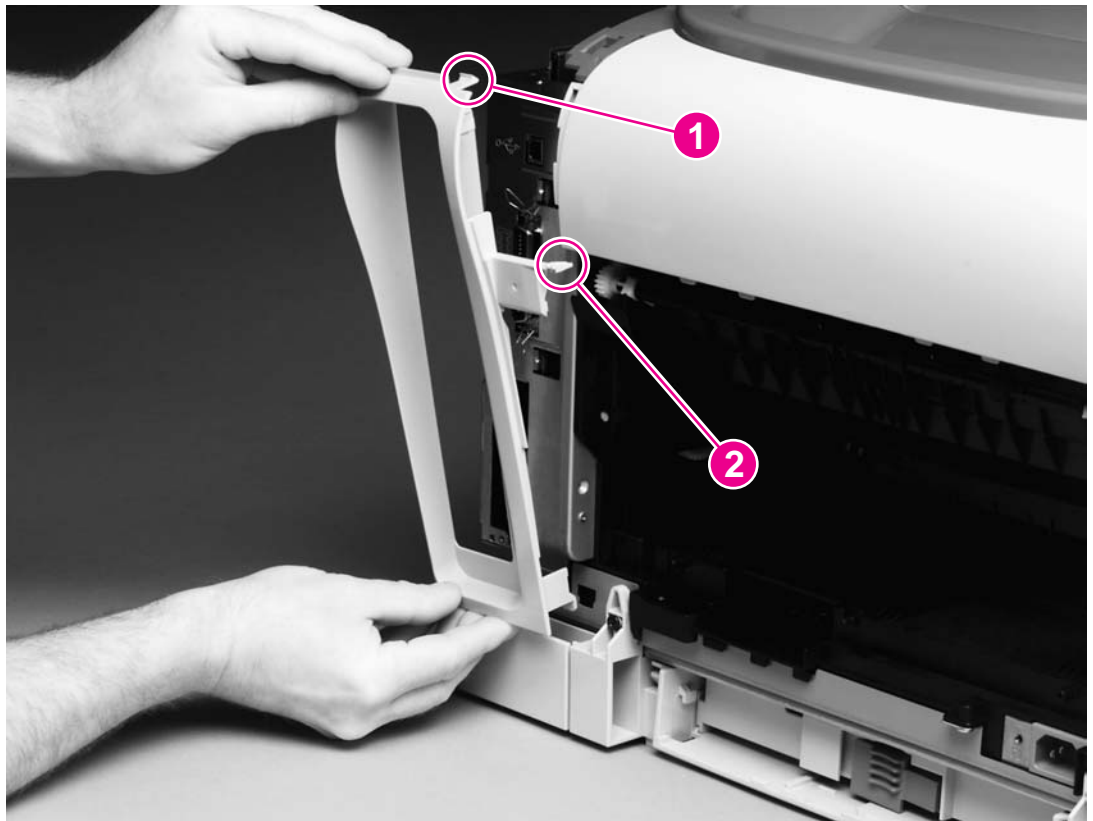

Figure 5-7. Removing the interface cover

Formatter assemblies

Formatter cage

1. Remove the following cover and assembly:
 - Right-side cover (see [Right- and left-side covers](#))
 - Interface cover (see [Interface cover](#))
2. Use a flatblade screwdriver to pinch the tab on the cable connector (callout 1) to unplug the connector.

3. Remove two screws (callout 2) from the formatter cage.

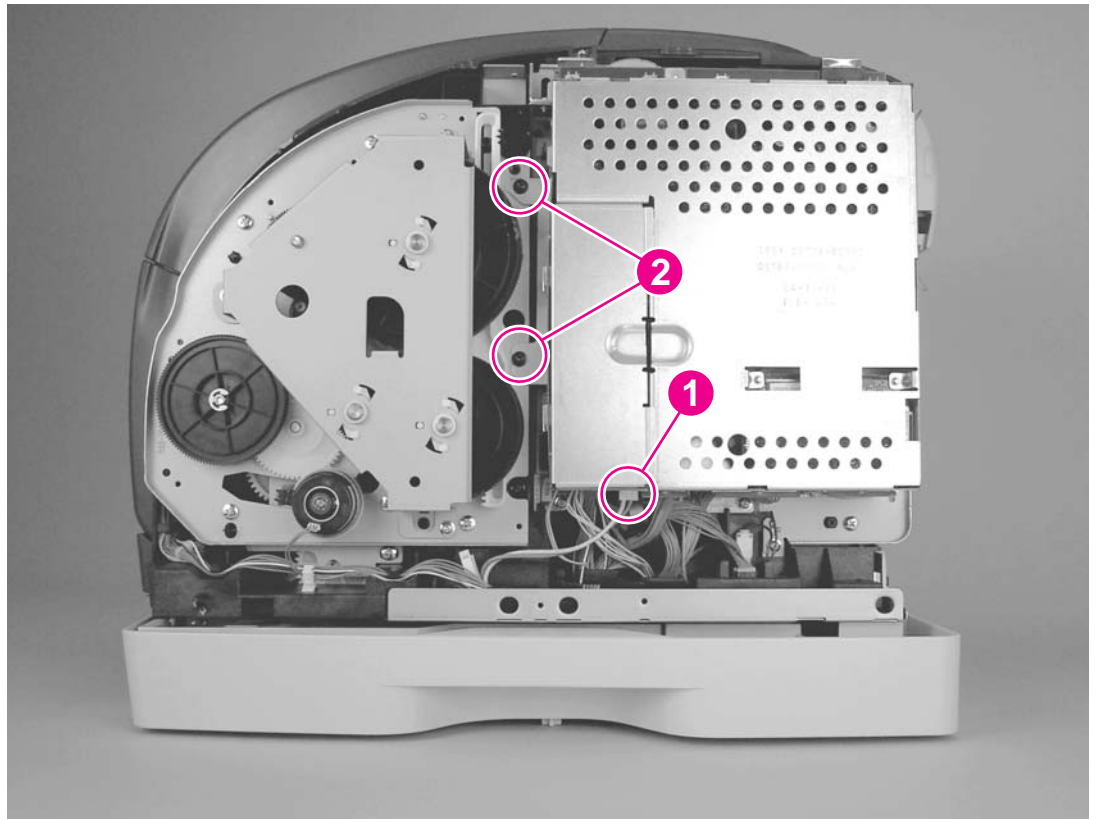

Figure 5-8.

Removing the formatter cage (1 of 2)

4. Unplug one flat, flexible cable (callout 3)
5. Remove two screws (callout 4) from the formatter cage.

6. Rotate the formatter cage upward to remove it from two hooks (callout 5).

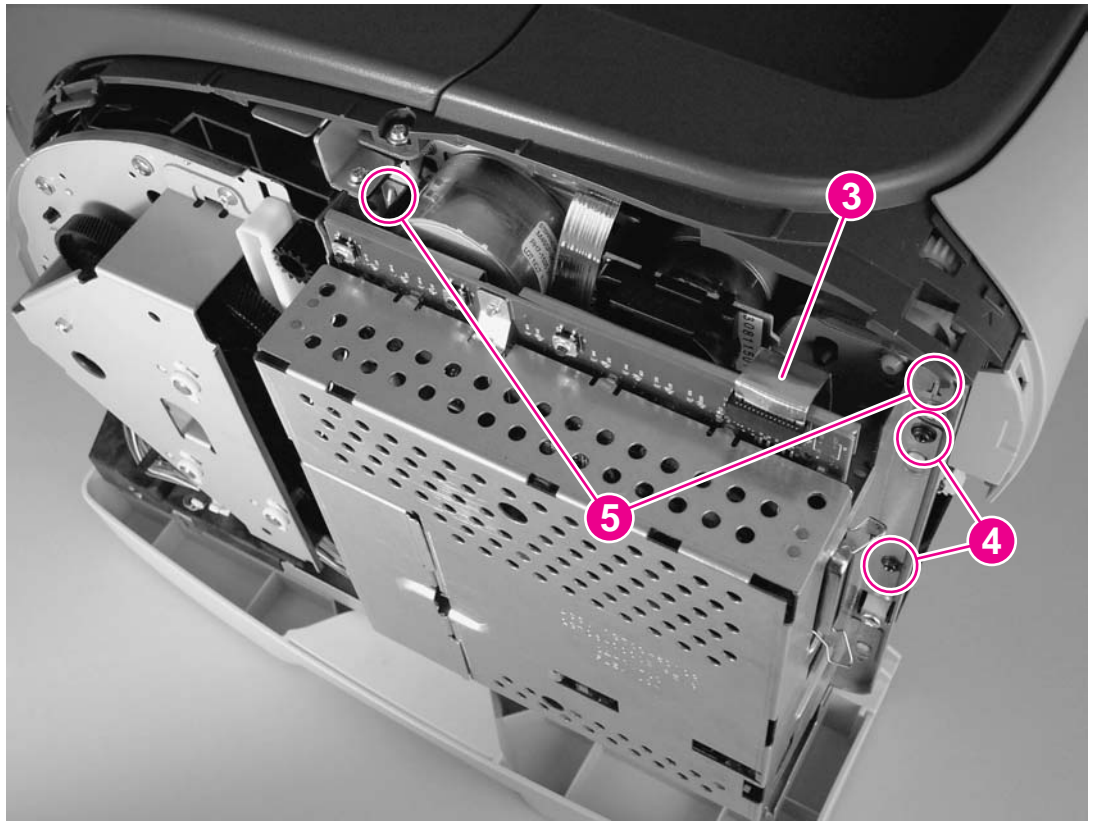

Figure 5-9. Removing the formatter cage (2 of 2)

Formatter

1. Remove the following cover and assemblies:
 - Right-side cover (see [Right- and left-side covers](#))
 - Interface cover (see [Interface cover](#))
 - Formatter cage (see [Formatter cage](#))
2. Remove five screws (callout 1) from the metal plate on the back of the formatter cage, and then remove the metal plate.

3. Lift the front edge (callout 2) of the plate upward to clear the tabs (callout 3, two of five shown in the callout), and then lift the plate away from the formatter cage.

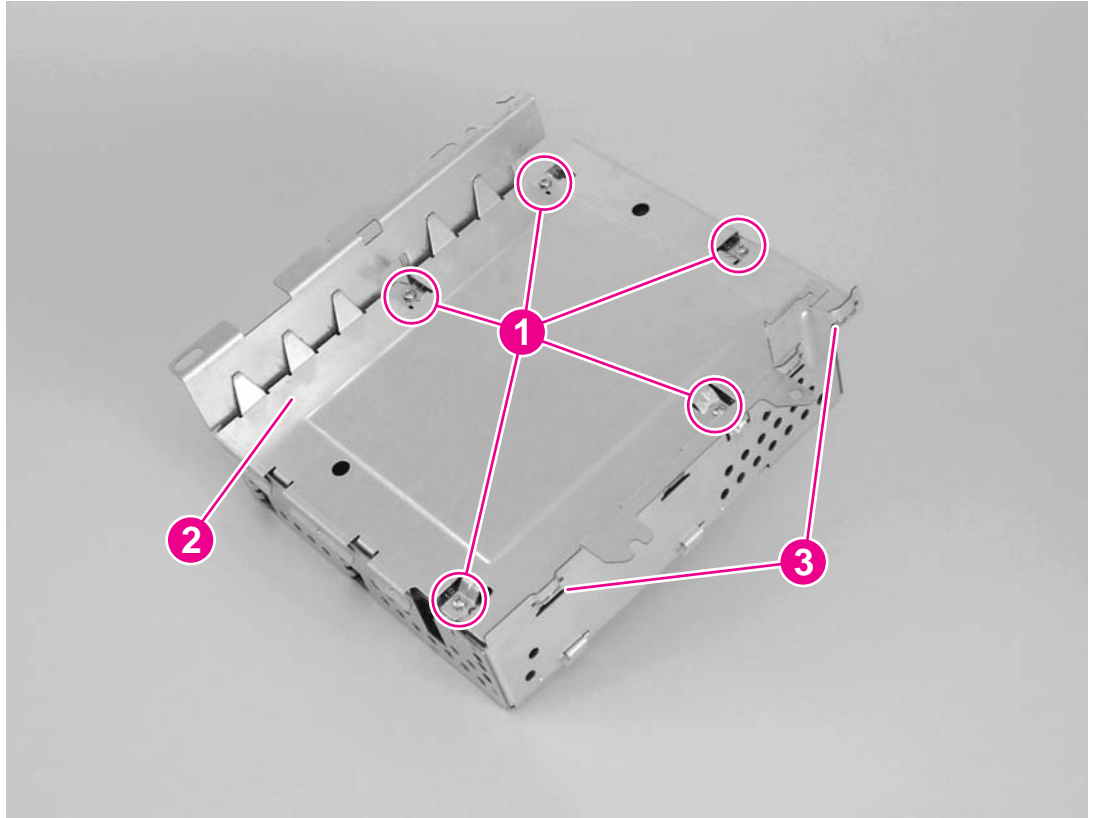

Figure 5-10. Removing the formatter (1 of 2)

4. Unplug one connector (callout 4), and then lift the formatter from the formatter cage.

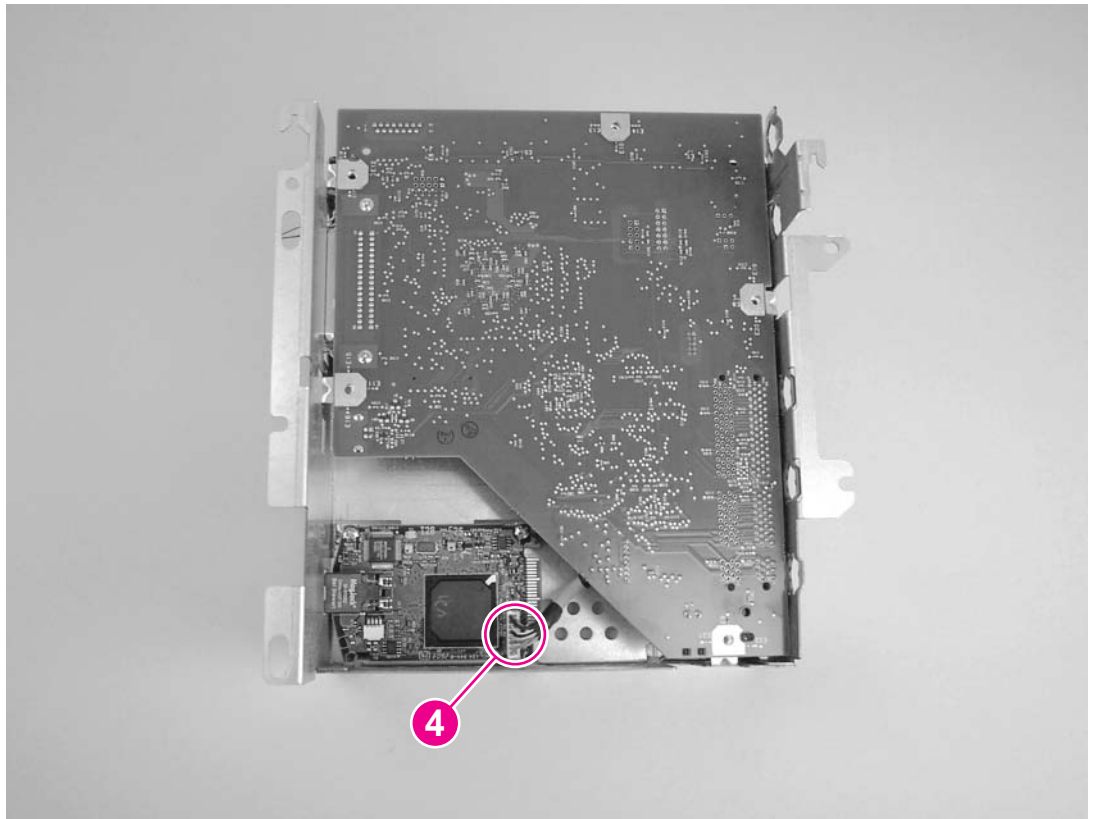

Figure 5-11.

Removing the formatter (2 of 2)

Reinstallation tip

Make sure that the metal clips on the interface connector are in the "open" position, perpendicular to the connector. If they are in the "closed" position when the formatter is reinstalled, they do not fit correctly through the hole in the formatter cage.

5. To remove the network card, remove two screws (callout 5) and then lift the network card from the formatter cage.

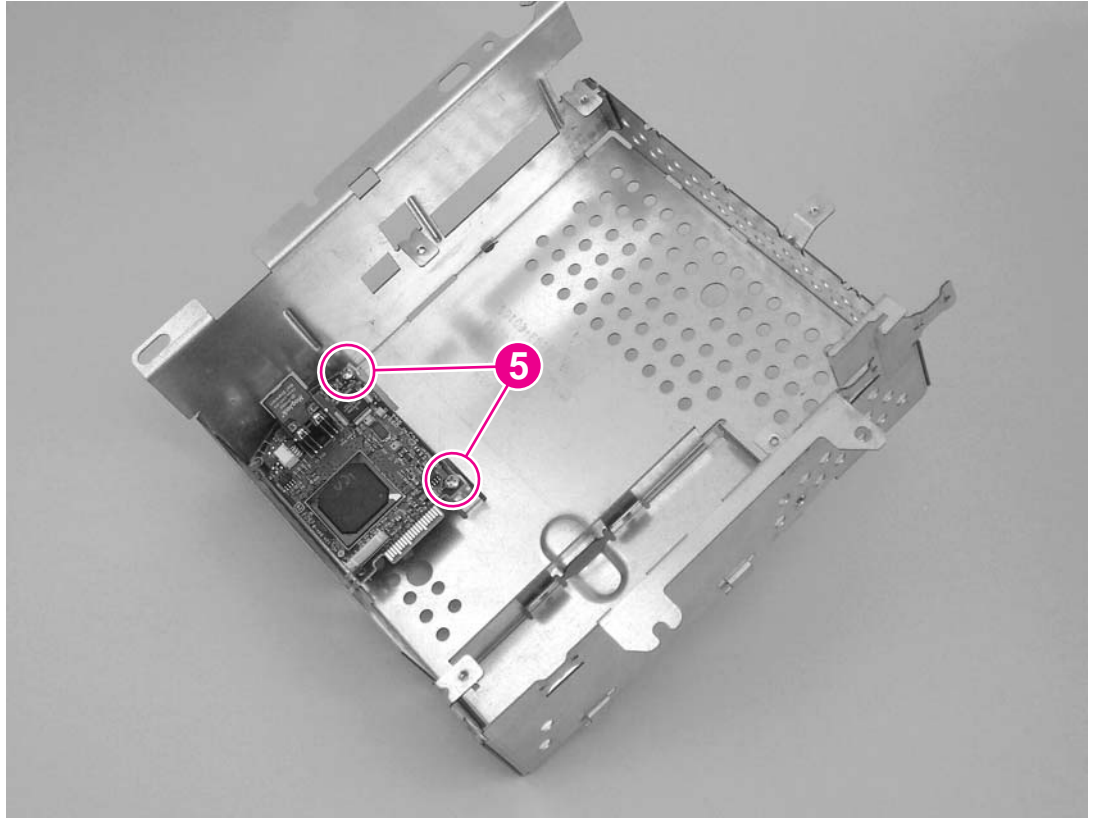

Figure 5-12. Removing the network card

Fuser motor

1. Remove the following covers and assembly:
 - Right-side cover (see [Right- and left-side covers](#))
 - Interface cover (see [Interface cover](#))
 - Formatter cage (see [Formatter assemblies](#))
2. Unplug one connector (callout 1).
3. Remove four screws (callout 2).

4. Pull the motor away from the printer.

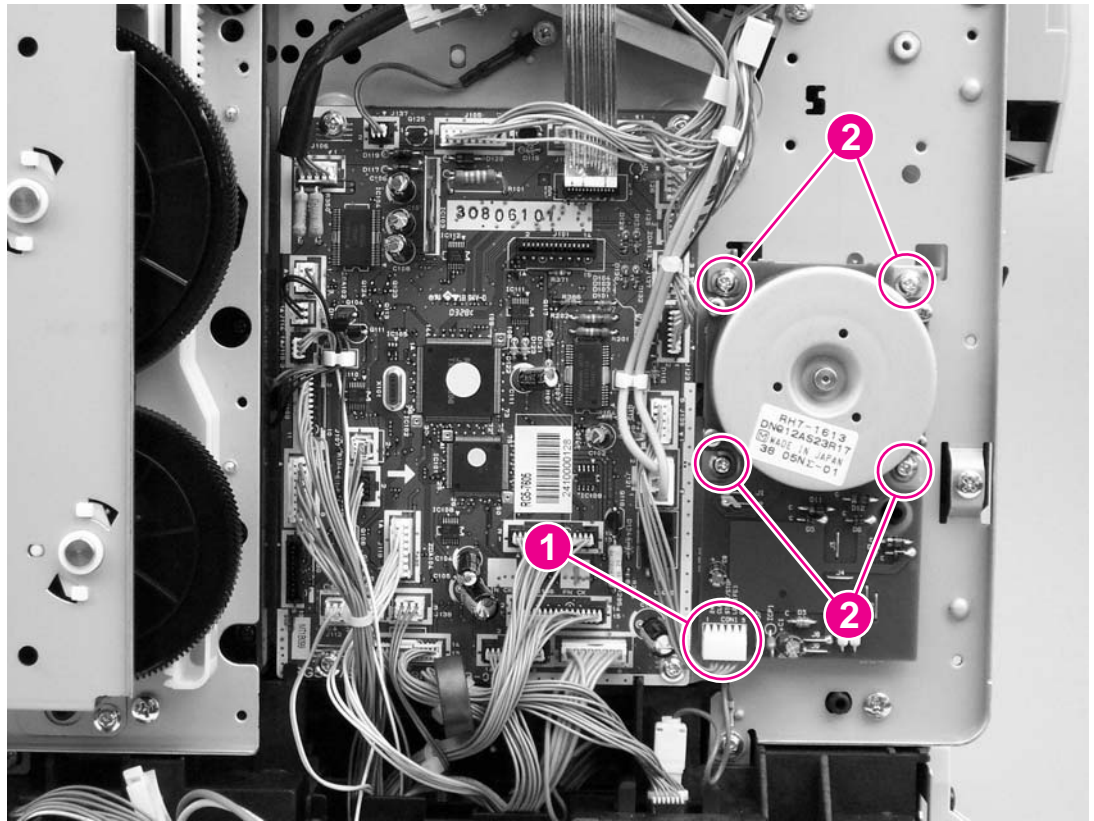

Figure 5-13. Removing the fuser motor

Dc controller

1. Remove the following covers and assembly:
 - Right-side cover (see [Right- and left-side covers](#))
 - Interface cover (see [Interface cover](#))
 - Formatter cage (see [Formatter assemblies](#))
2. Unplug the flat, flexible cable (callout 1).
3. Release the cables from two cable-holders (callout 2)
4. Unplug one cable connector (callout 3) by pressing and releasing the tab on the side of the connector.
5. Unplug two cable connectors (callout 4) by releasing a clip on each connector (see the detail in the lower-left corner of [Figure 5-14. Removing the dc controller](#)).

6. Unplug the remaining 24 cable connectors, and then remove the two screws (callout 5) at the bottom of the dc controller before removing two screws (callout 6) at the top of the dc controller.

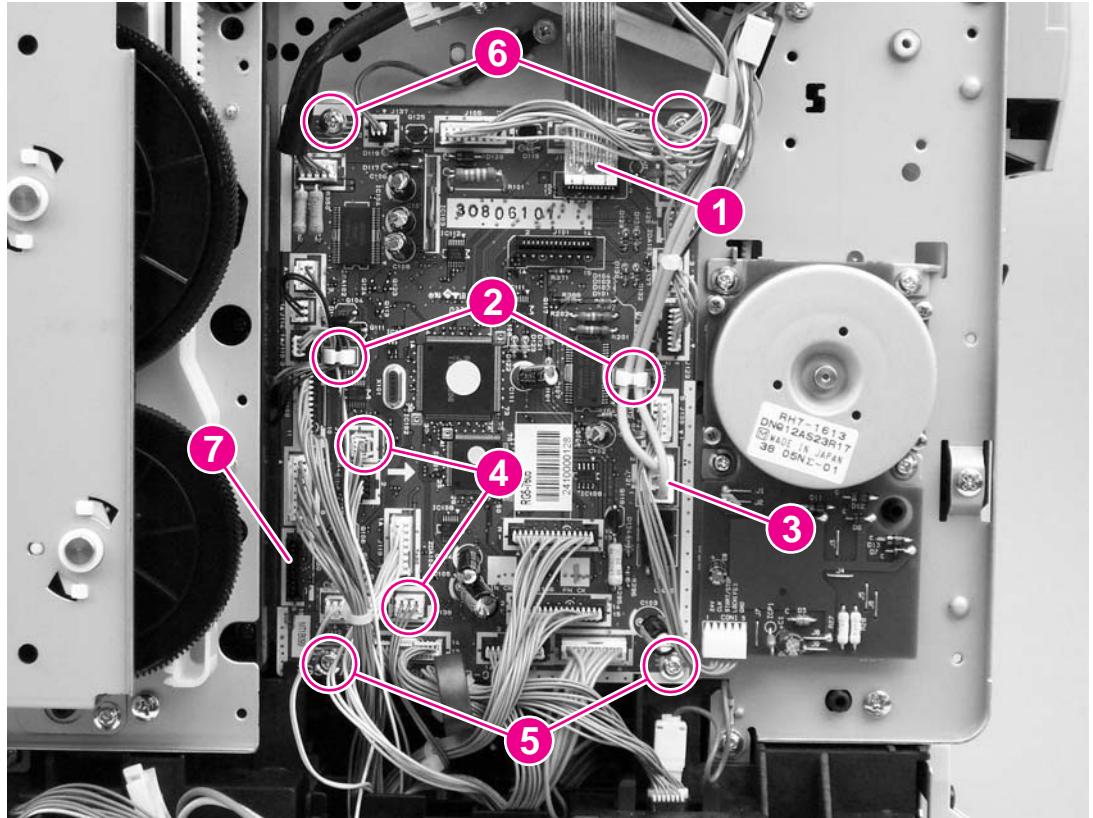

Figure 5-14. Removing the dc controller

7. Lift the dc controller up and then away from the printer.

Reinstallation tip

The connection that remains empty upon reinstallation is shown in callout 7 in [Figure 5-14. Removing the dc controller](#). The connection is used to "flash" the dc controller.

Optional tray 2 (250-sheet tray)

1. Remove the Right- and left-side covers (see [Right- and left-side covers](#)).
2. If optional tray 3 is installed, lift the printer (and optional tray 2) up and away from optional tray 3.

3. Remove one screw (callout 1) from optional tray 2.

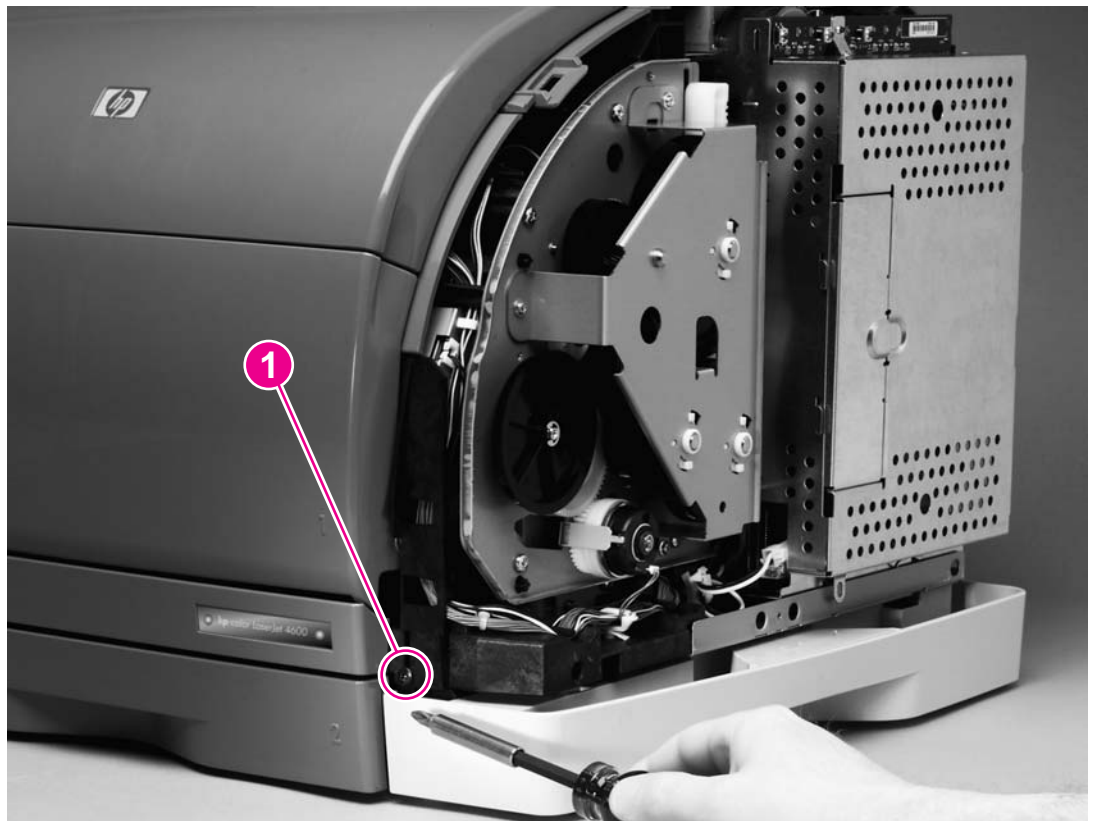

Figure 5-15.

Removing optional tray 2 (1 of 2)

4. Remove one screw (callout 2) from the left side of the printer.
5. Remove two screws (callout 3) from the back of optional tray 2.

6. Grasp the printer frame on each side, and then carefully lift the printer off of tray 2.

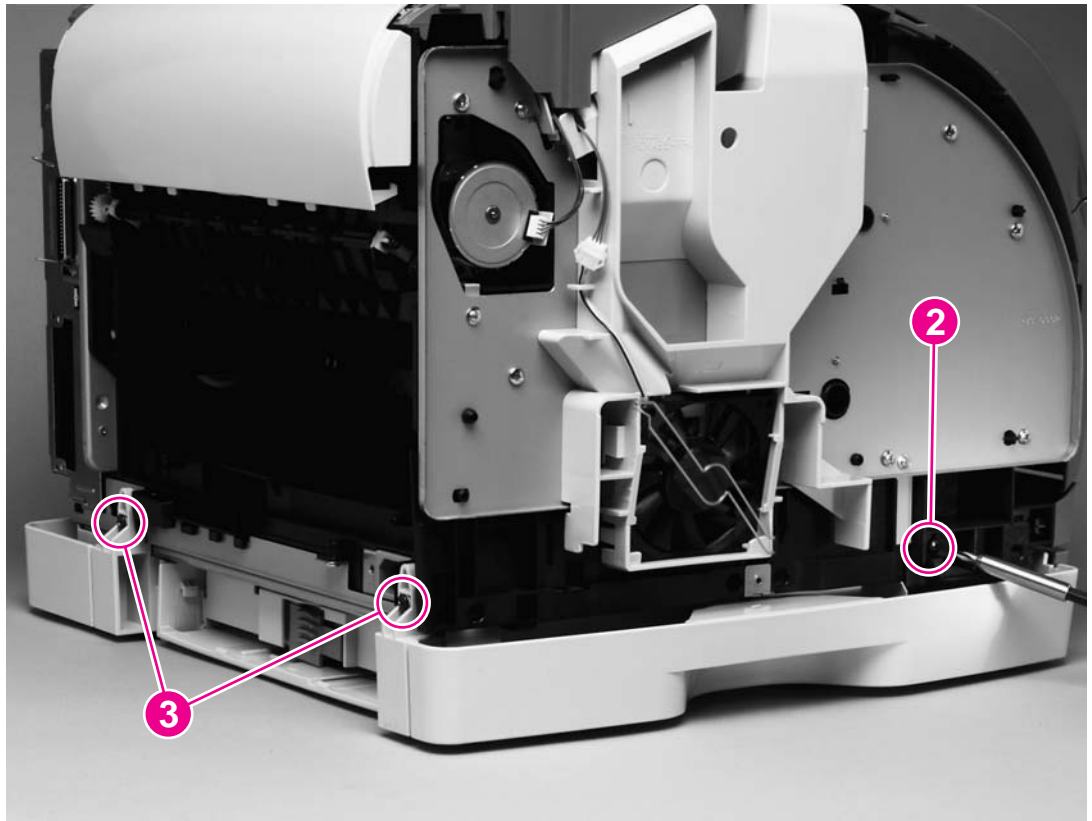

Figure 5-16. Removing optional tray 2 (2 of 2)

Carousel-engagement motor

1. Remove the left-side cover (see [Right- and left-side covers](#)).
2. Unplug one cable connector (callout 1).
3. Remove two screws (callout 2).
4. Rotate the motor counterclockwise to clear the metal lock-tab.

5. Lift the carousel-engagement motor away from the printer to remove it.

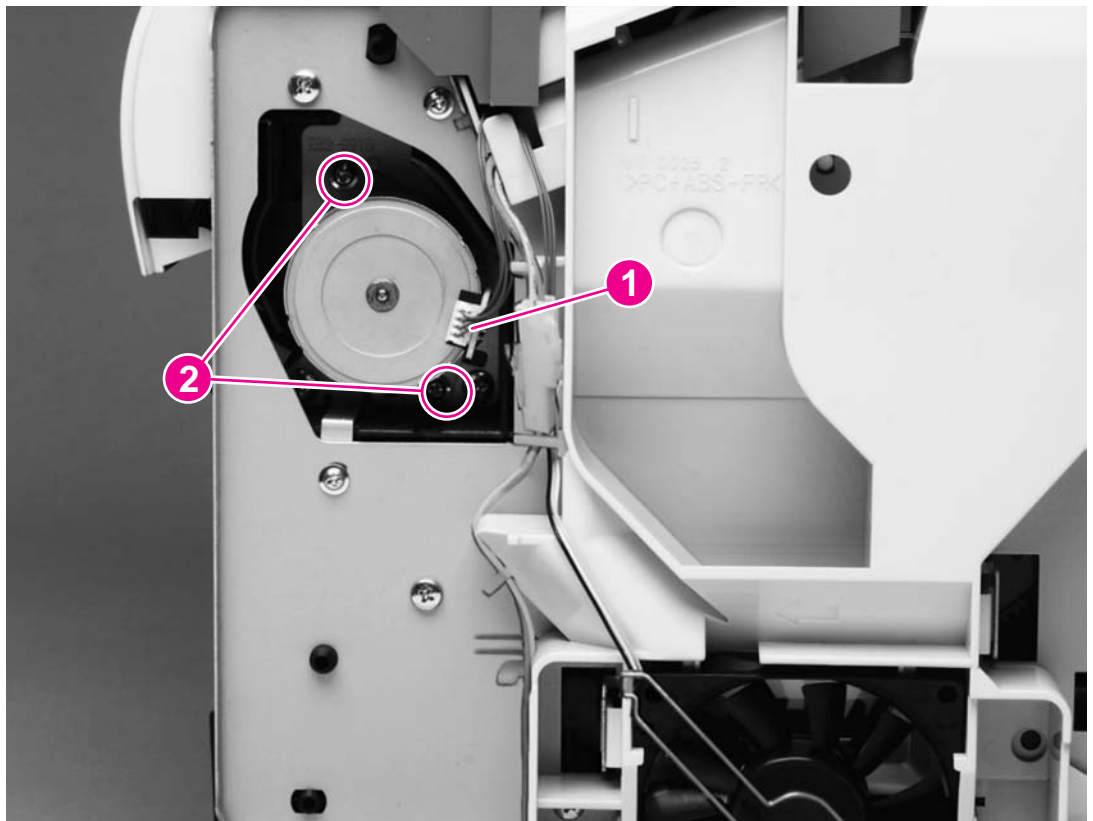

Figure 5-17. Removing the carousel-engagement motor

Front lower cover

1. Remove the Right- and left-side covers (see [Right- and left-side covers](#)).
2. Use the small flatblade screwdriver to lift the plastic catch (callout 1) off of the tab on the left side of the printer.

3. Pull the cover away from the printer to remove it.

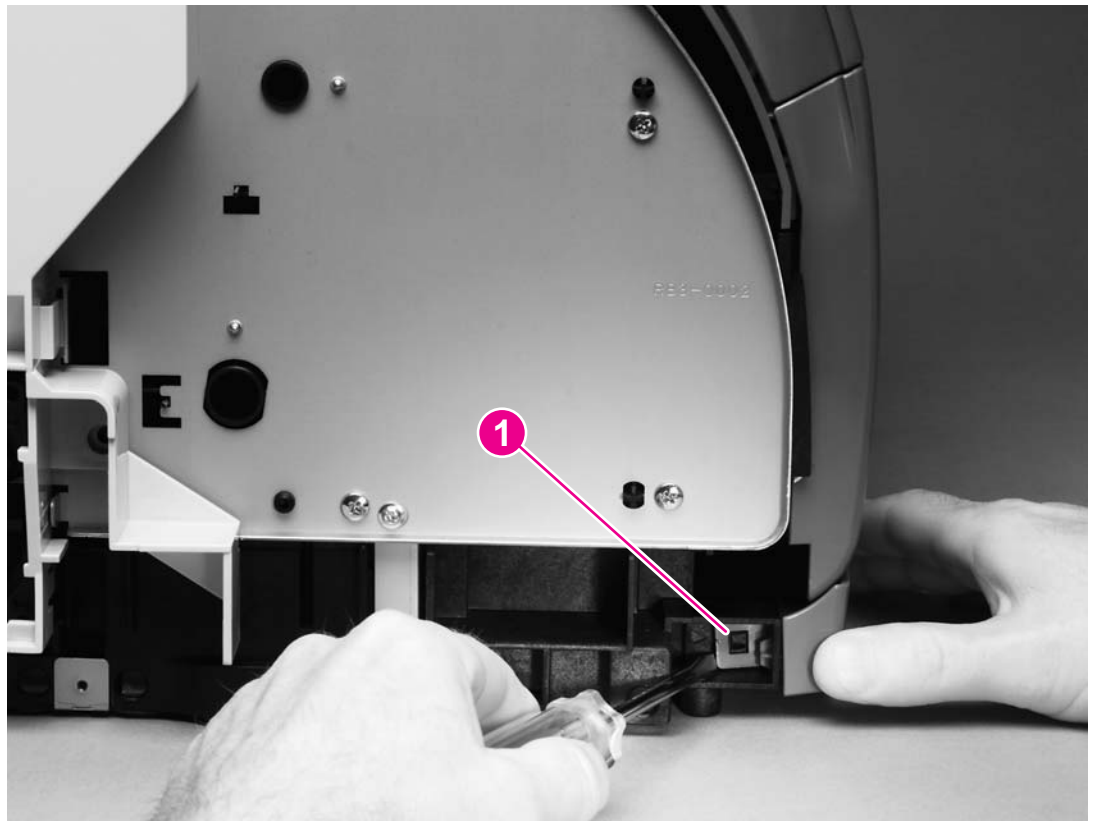

Figure 5-18. Removing the front lower cover

Back cover

1. Remove the Right- and left-side covers (see [Right- and left-side covers](#)).
2. Use a flatblade screwdriver to release two internal tabs (callout 1), one at each side of the cover.

3. Rotate the top of the cover away from the printer and then downward to release the internal tabs under the cover.

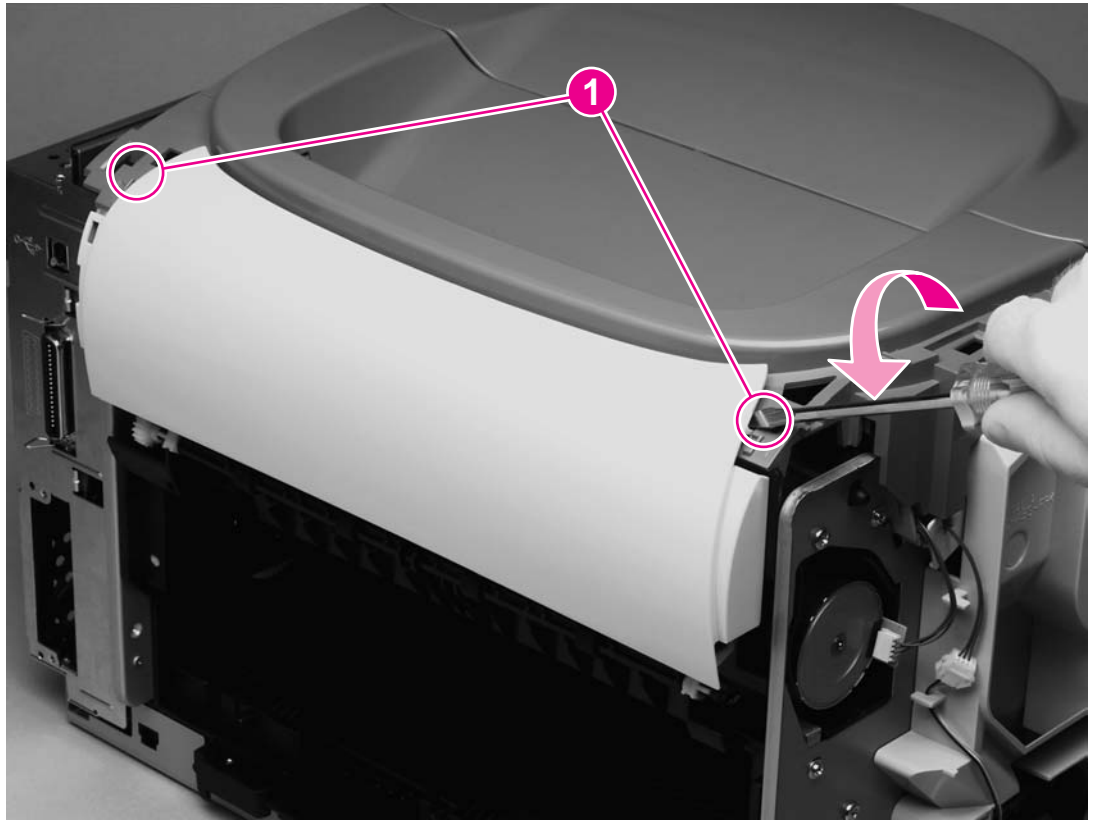

Figure 5-19. Removing the back cover

Top cover

1. Remove the following covers:
 - Right- and left-side covers (see [Right- and left-side covers](#))
 - Interface cover (see [Interface cover](#))
 - Back cover (see [Back cover](#))
2. Open the top door.
3. Press the small tab on the gear (callout 1) to release the gear.

4. Remove the gear to release the top-door rack (callout 2).

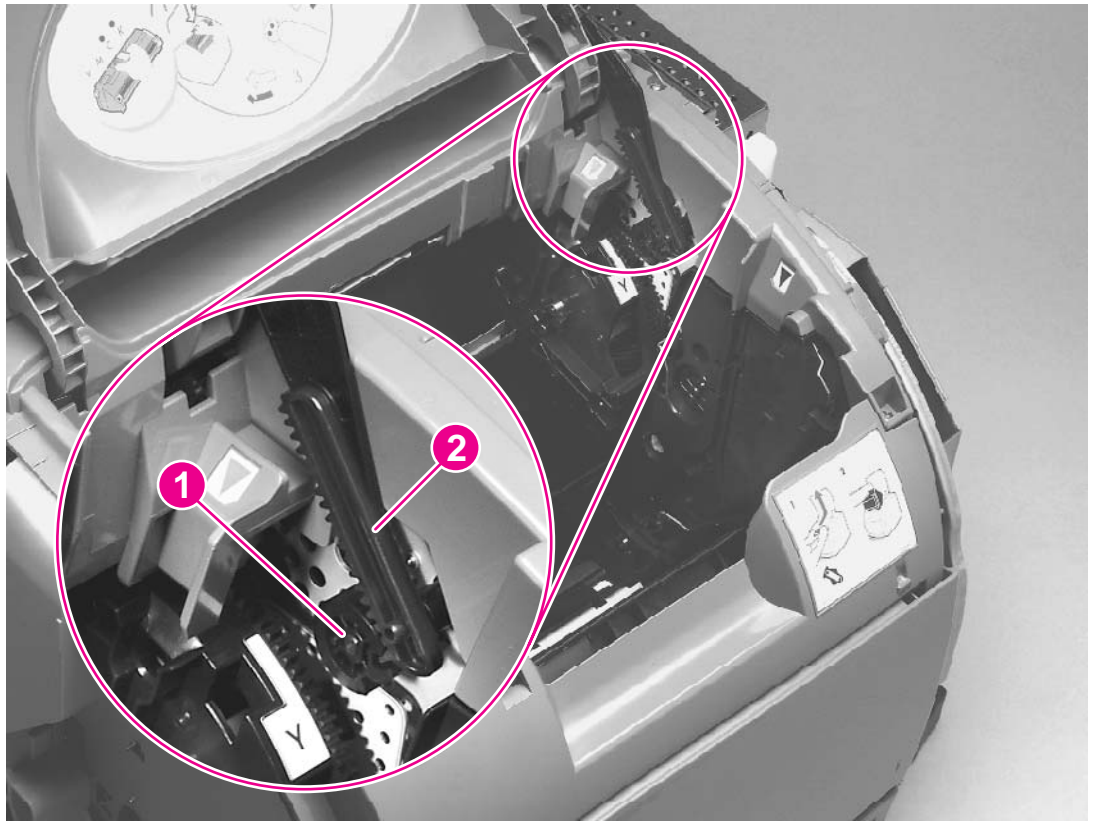

Figure 5-20. Removing the top cover (1 of 2)

Note Return the gear to its shaft after releasing the top door rack.

5. Remove three screws (callout 3) from the top cover.

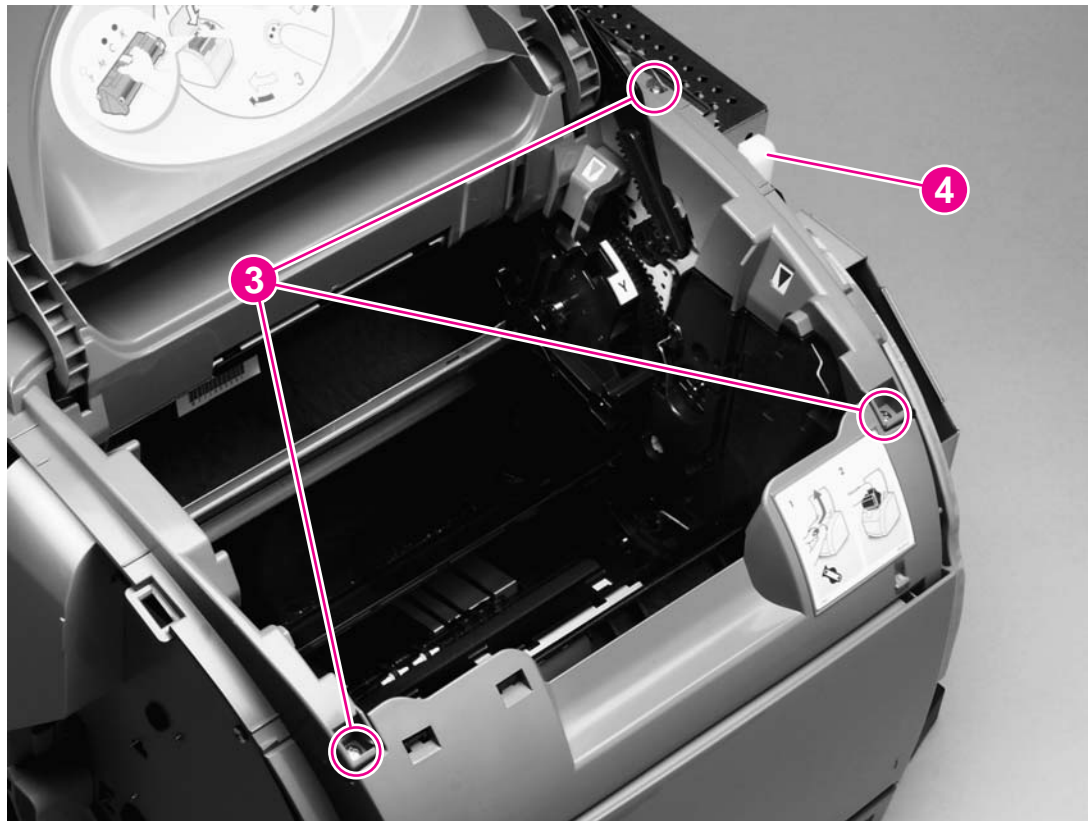

Figure 5-21.

Removing the top cover (2 of 2)

6. Lift the top cover off of the printer.

Reinstallation tip

Lift the vertical rack (callout 4) up to its highest position, and then align the notch on the gear with the lip on the top-door rack.

Top door

1. Remove the following covers:
 - Right- and left-side covers (see [Right- and left-side covers](#))
 - Interface cover (see [Interface cover](#))
 - Back cover (see [Back cover](#))
 - Top cover (see [Top cover](#))
2. Turn the top cover over.
3. Firmly flex the top-door arm (callout 1) to release the plastic pin (callout 2) on either side.

4. Release the pin on the other side and slip the top door arms through the holes in the top cover.

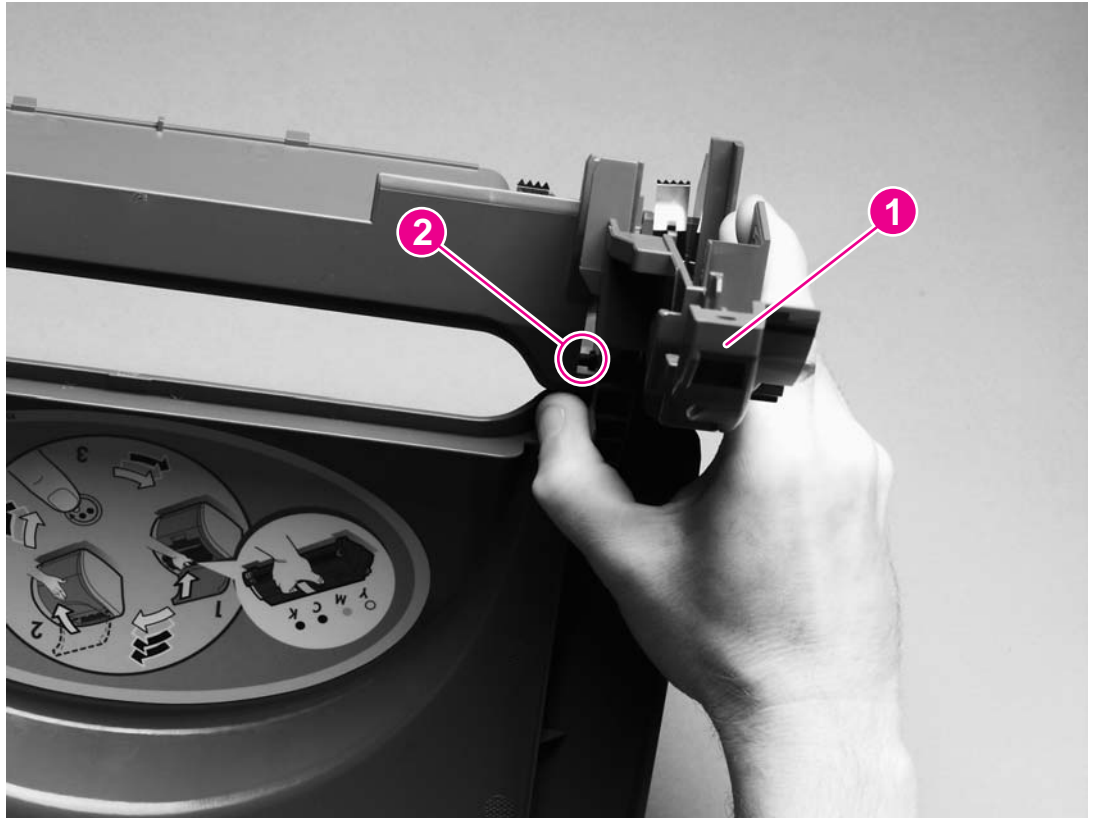

Figure 5-22. Removing the top door (1 of 2)

Reinstallation tip

Slide the door arm on one side through the hole in the top cover and into place before attempting to reattach the other side.

5. Slide the top door rack (callout 3) off of its pin at the right side of the cover.

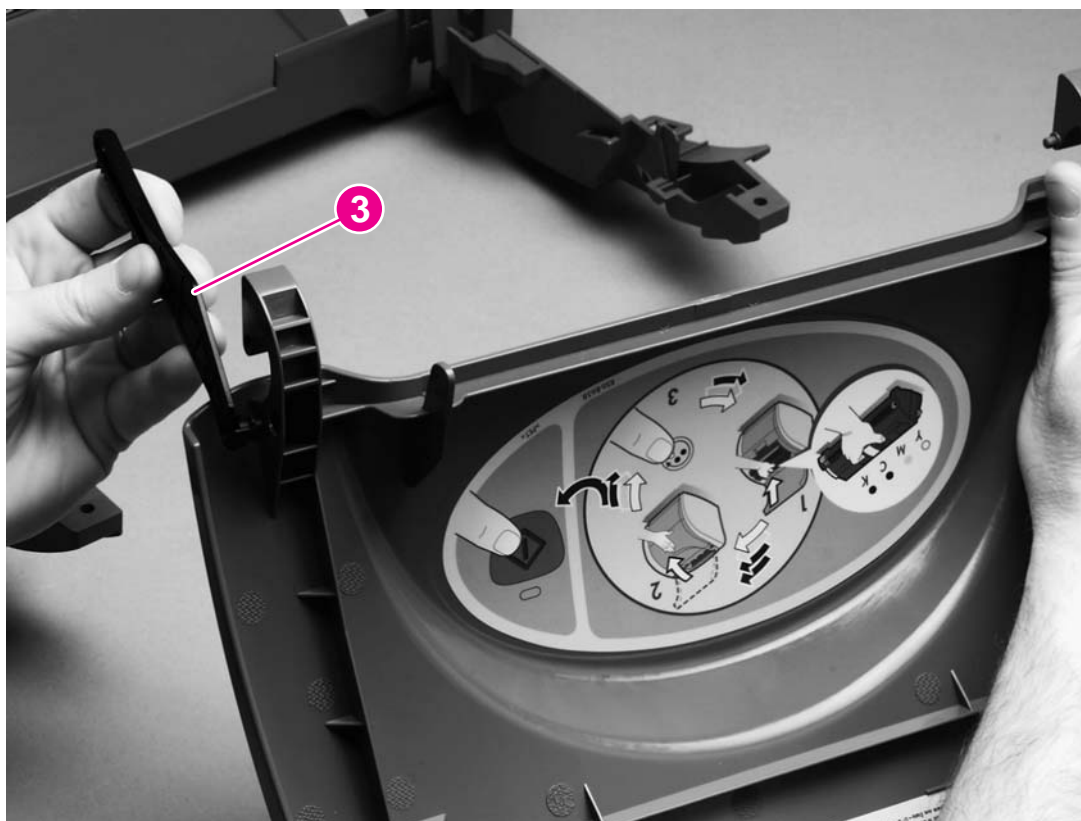

Figure 5-23. Removing the top door (2 of 2)

Air duct and fan

1. Remove the following covers:
 - Right- and left-side covers (see [Right- and left-side covers](#))
 - Interface cover (see [Interface cover](#))
 - Back cover (see [Back cover](#))
 - Top cover (see [Top cover](#))
2. Remove one connector (callout 1).
3. Release two tabs (callout 2).

4. Lift the air duct straight up to release two hidden tabs at the top of the air duct, and lift the air duct away from the printer.

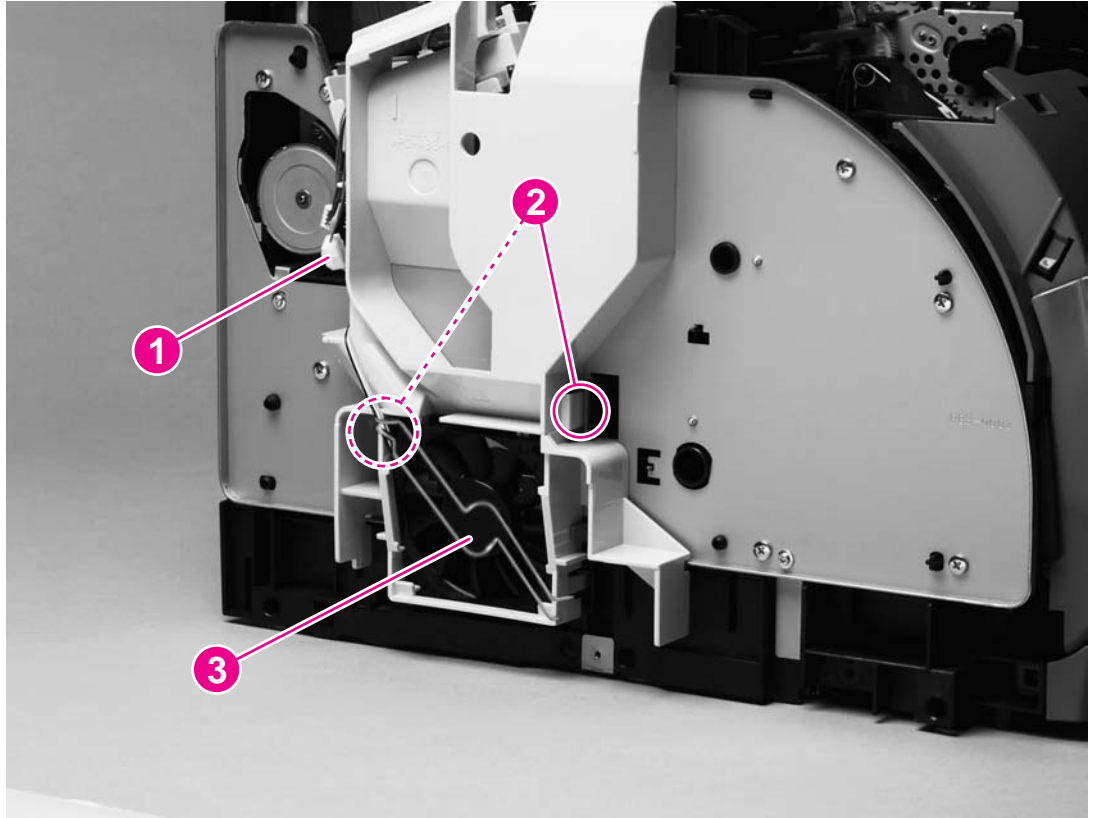

Figure 5-24.

Removing the air duct

5. To remove the fan (callout 3) from the air duct, release two tabs on the side of the air duct that faces the printer and then lift the fan from the air duct.

Laser/scanner assembly

1. Remove the following covers:
 - Right- and left-side covers (see [Right- and left-side covers](#))
 - Interface cover (see [Interface cover](#))
 - Back cover (see [Back cover](#))
 - Top cover (see [Top cover](#))
2. Unplug two cable connectors (callout 1), and unroute the cables from the cable holders.
3. Disconnect the flat flexible cable from the cable socket (callout 2) on the laser/scanner.
4. Rotate the lower part of the top output bin cover (callout 3) toward the front of the printer, and then lift away from the printer.
5. Remove four screws (callout 4).
6. Unroute the cables from the cable harness attached to the back of the laser/scanner.

- Lift the laser/scanner assembly straight up to remove it from the printer.

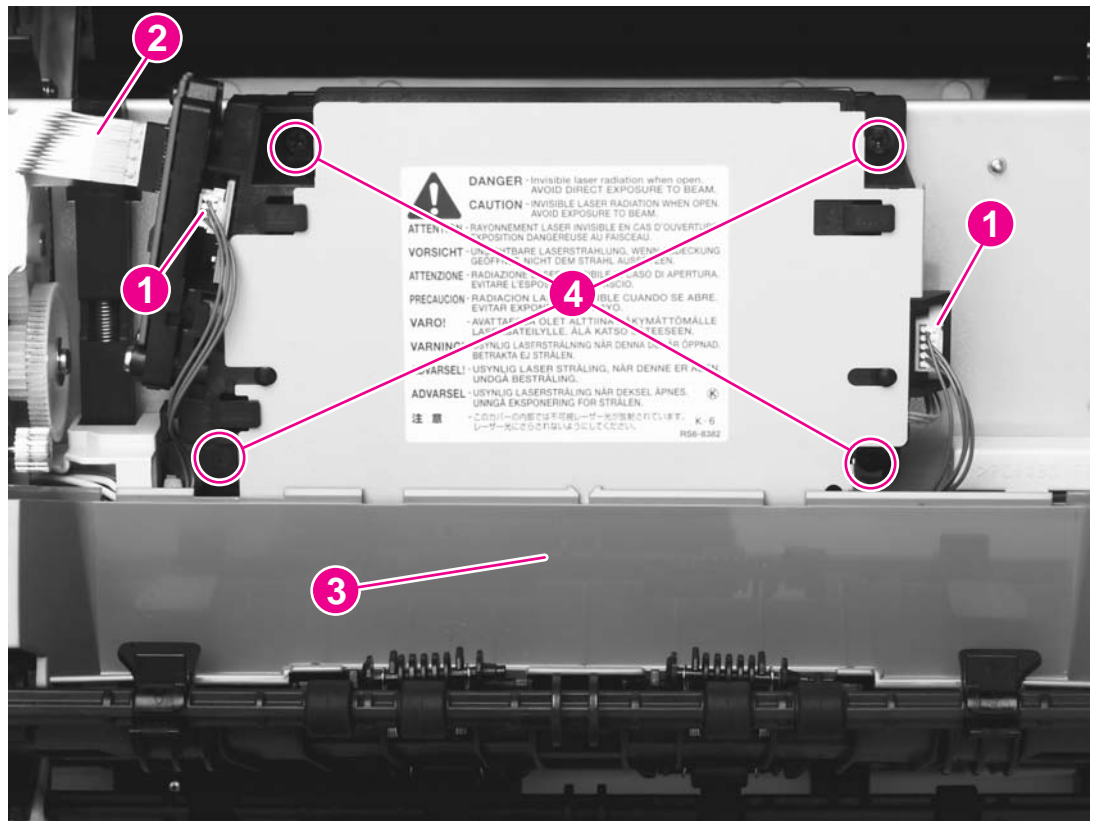

Figure 5-25.

Removing the laser/scanner assembly

Reinstallation tip

When replacing the top output bin cover (callout 3 in [Figure 5-25. Removing the laser/scanner assembly](#)), place the guides (on the top output bin roller) on top of the cover, as shown in [Figure 5-26. Reinstalling the top output bin cover](#).

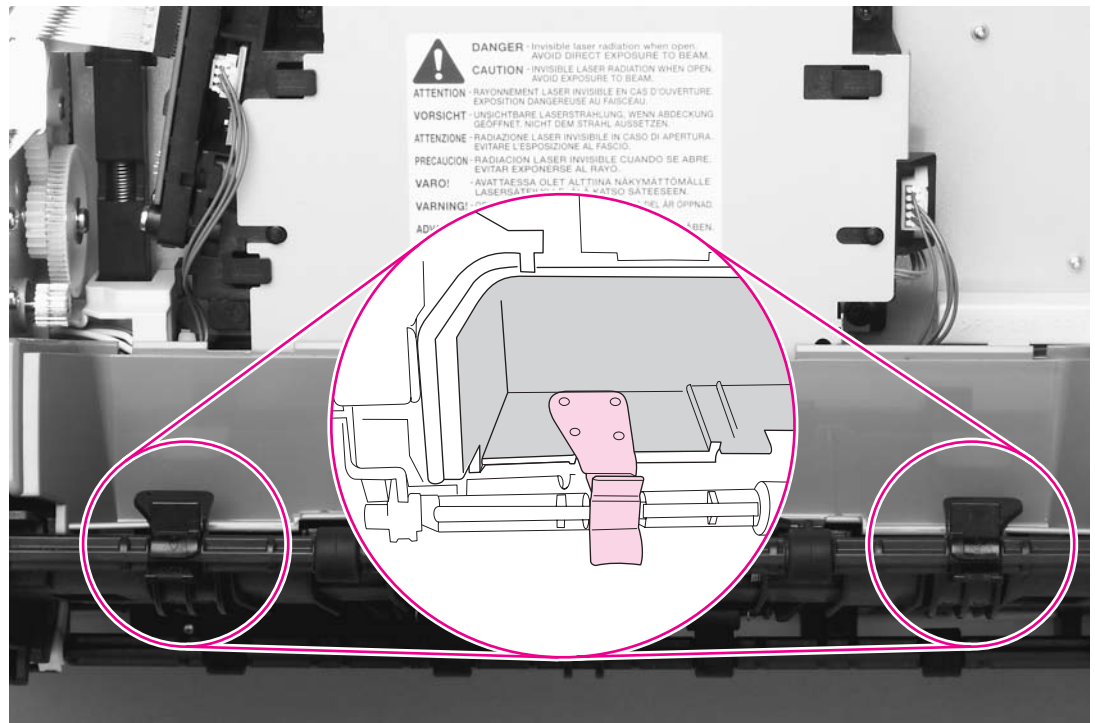

Figure 5-26.

Reinstalling the top output bin cover

Front cover

1. Remove the following covers:
 - Right- and left-side covers (see [Right- and left-side covers](#))
2. Use a flatblade screwdriver to release two internal tabs (callout 1), one at each side of the printer.
3. Rotate the cover upward to release four internal tabs (callout 2) underneath the cover.

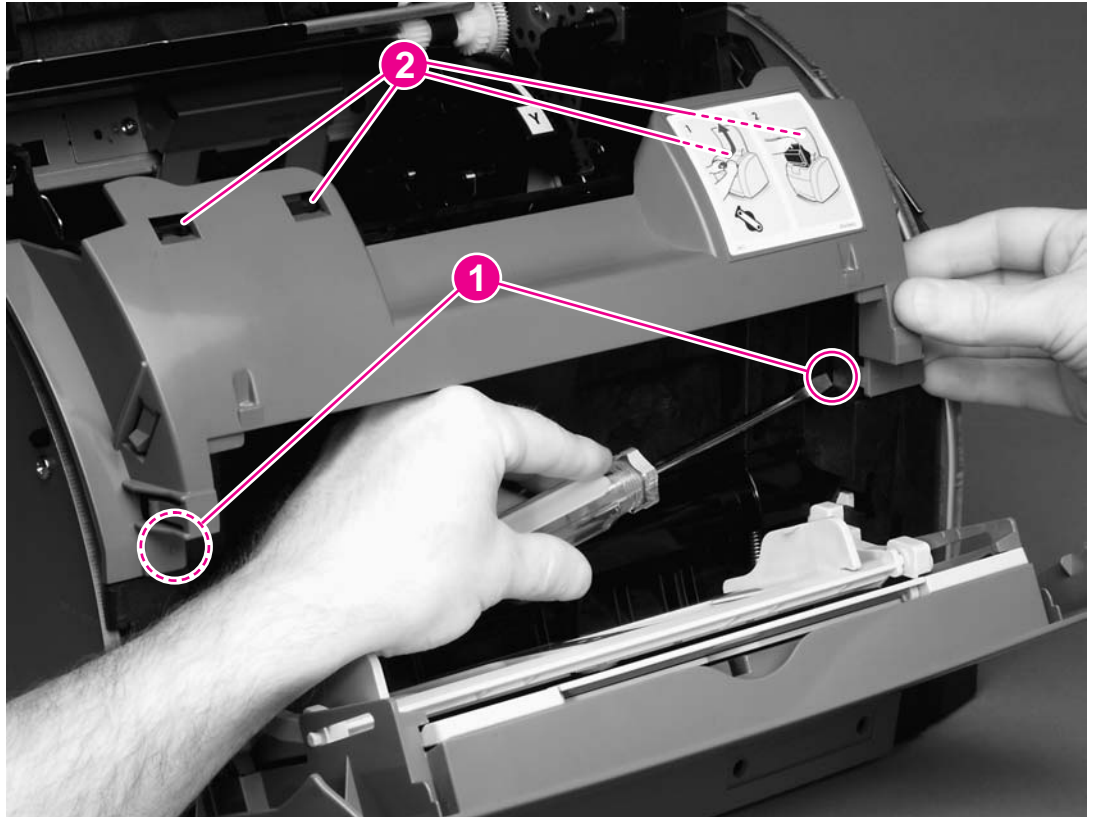

Figure 5-27.

Removing the front cover

Reinstallation tip

Make sure that the tabs on each side of the cover click into place.

Density sensor and top-of-page sensor

1. Remove the following covers:
 - Right- and left-side covers (see [Right- and left-side covers](#))
 - Front cover (see [Front cover](#))

2. Press the tab (callout 1) on the sensor cover to release the cover, and then lift the cover up and away from the printer.

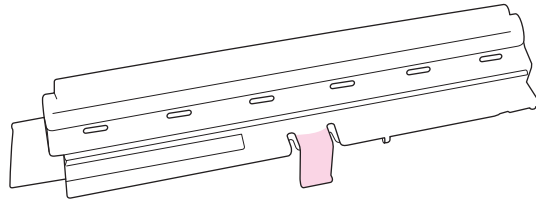

Figure 5-28.

Removing the density sensor cover

3. Unplug one connector (callout 2).
4. Remove the two screws (callout 3).
5. Lift the density sensor straight up to remove it from the printer.
6. Unplug one connector (callout 4) from the top-of-page sensor.
7. Remove one screw (callout 5) and then lift the top-of-page sensor straight up and away from the printer.

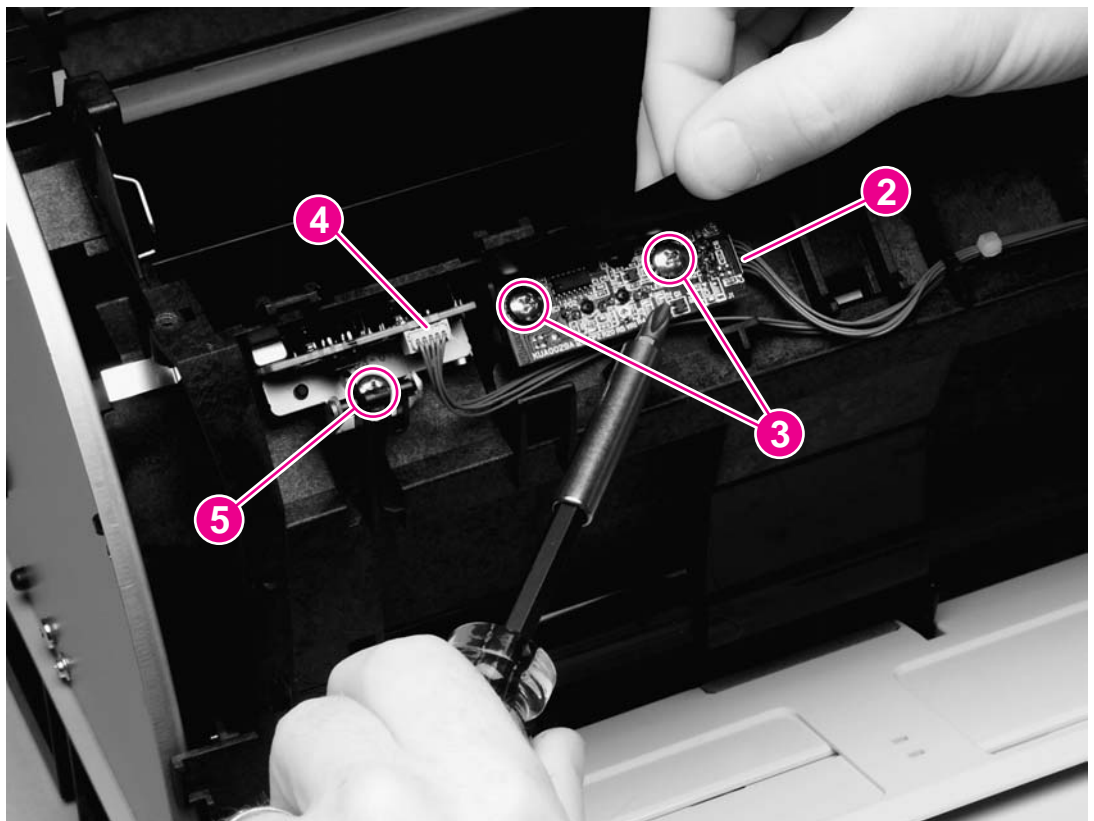

Figure 5-29.

Removing the density sensor

E-label reader (for imaging-drum E-labels)

1. Remove the following covers and assembly:
 - Right- and left-side covers (see [Right- and left-side covers](#))
 - Interface cover (see [Interface cover](#))
 - Formatter cage (see [Formatter assemblies](#))
 - Front cover (see [Front cover](#))
2. Use the small flatblade screwdriver to lift two tabs (callout 1), one on each side of the E-label reader housing.
3. Slide the E-label reader off of its rails.

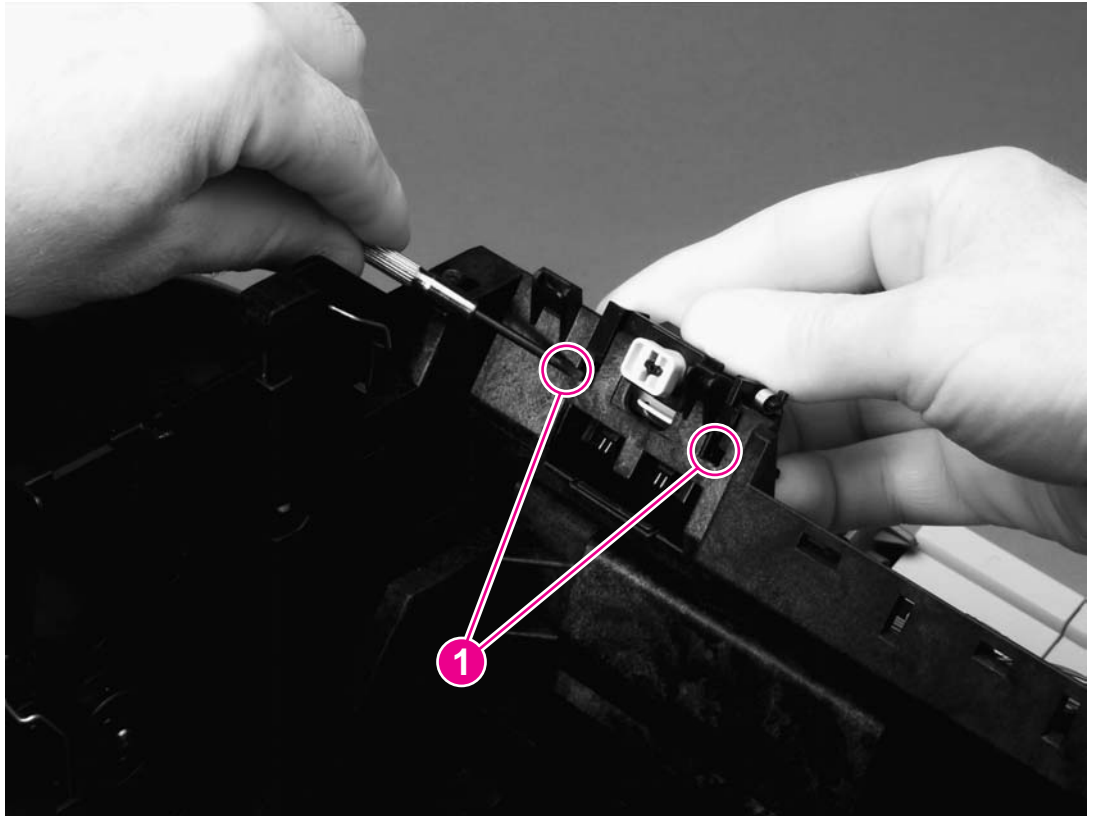

Figure 5-30. Removing the E-label reader (1 of 2)

4. Unplug the E-label reader connector (callout 2) from the dc controller.

Note

Examine the cable routing as you lift the E-label reader from the printer.

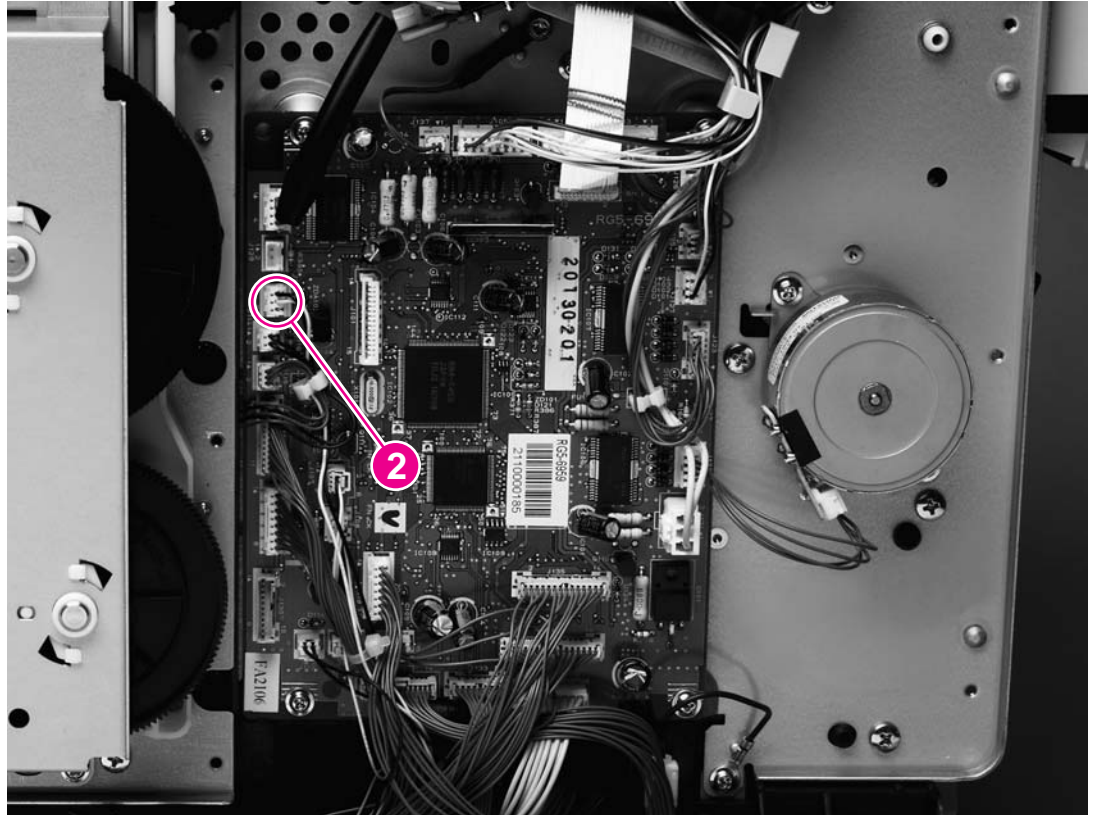

Figure 5-31. Removing the E-label reader (2 of 2)

Tray 1 (multipurpose tray)

1. Remove the following covers:
 - Right- and left-side covers (see [Right- and left-side covers](#))
 - Front lower cover (see [Front lower cover](#))
2. Open tray 1.
3. Press the multipurpose-roller cover (not shown) inward toward the printer, and then grasp the top edge to remove it.
4. Lift tray 1 slightly to align the notch (callout 1) in the tray 1 cover (callout 2) with the hinge pins of the tray 1 hinges (callout 3).
5. Push the left tray 1 hinge to the right while pulling the tray 1 cover to the left to carefully disengage the hinge pin from the tray 1 cover.
6. Disengage the right tray 1 hinge (callout 4) from the tray 1 cover.

9. Use needle-nose pliers to unhook two springs (callout 7), one at each side of the tray 1 guide, and then remove the tray 1 guide.

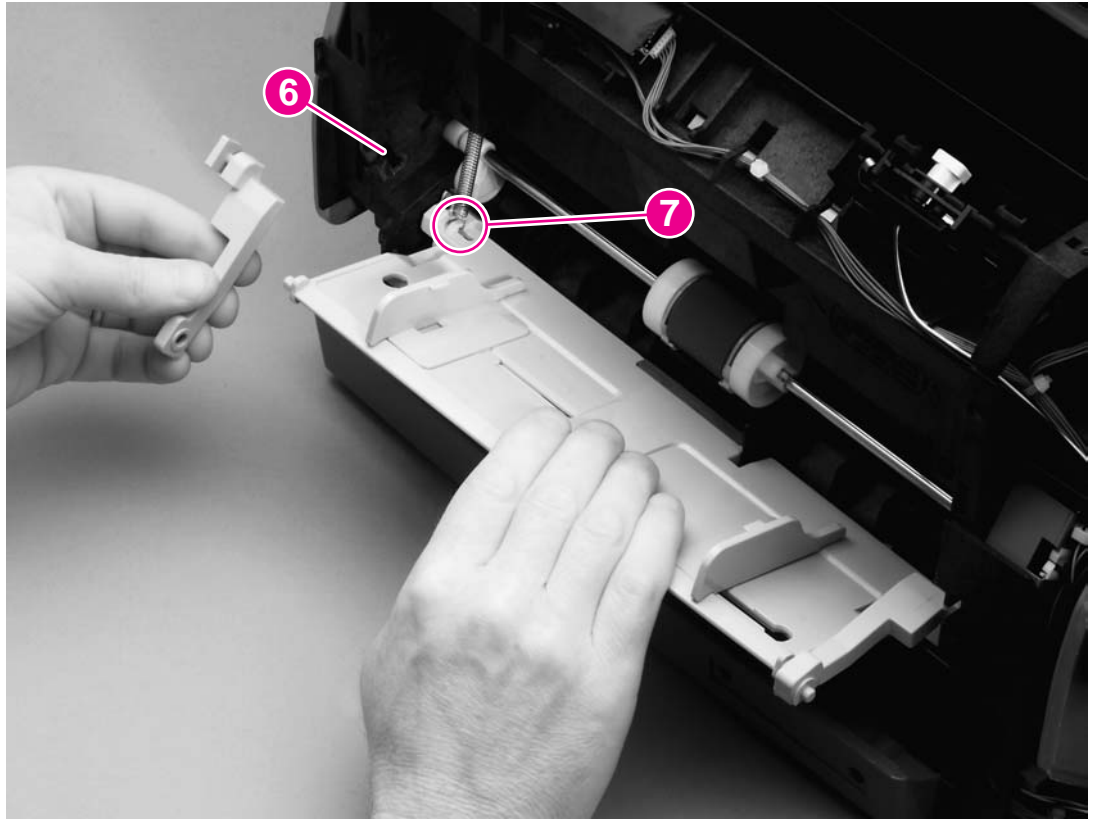

Figure 5-33.

Removing tray 1 (2 of 2)

Reinstallation tip

The two springs should remain attached to two pegs inside the printer. If the springs are not attached, use needle-nose pliers to reattach them before reinstalling the tray 1 guide.

Tray 1 separation pad assembly

1. Remove tray 1 (see [Tray 1 \(multipurpose tray\)](#)).

2. Remove one screw (callout 1) from the separation pad assembly, and then remove the separation pad assembly.

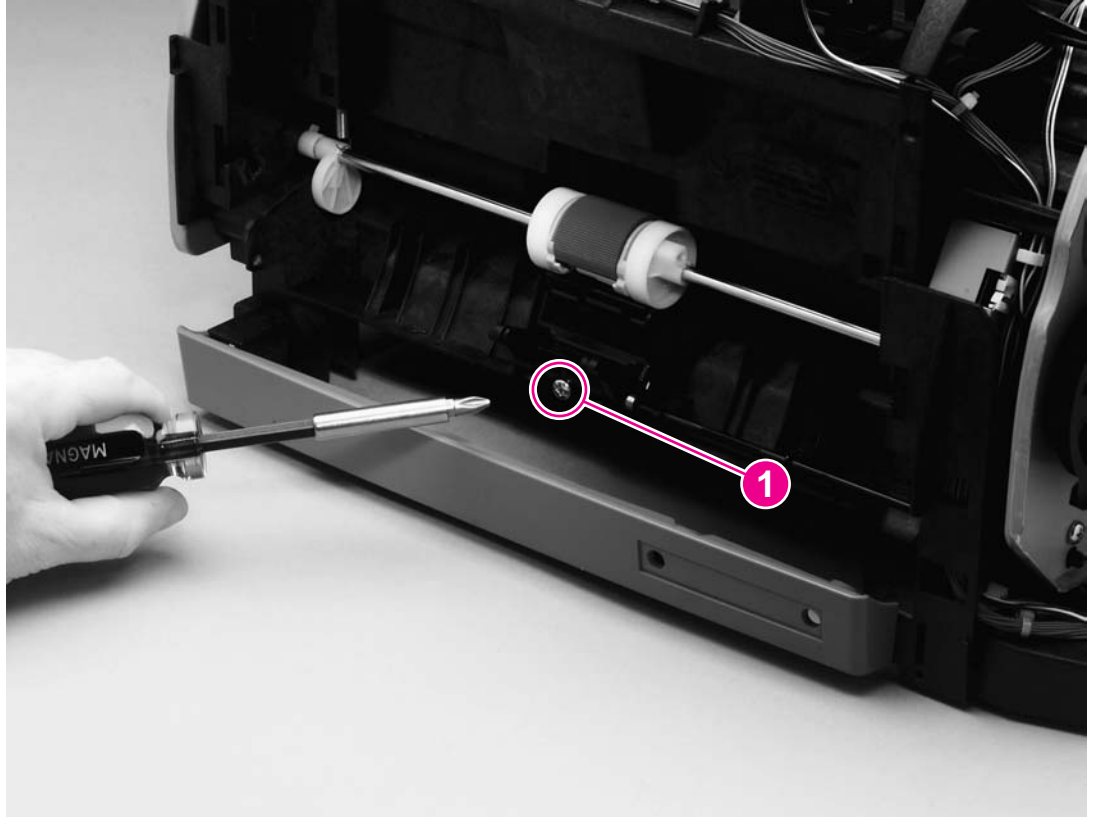

Figure 5-34. Removing the tray 1 separation pad assembly

Gear assembly

1. Remove the following covers and assembly:
 - Right- and left-side covers (see [Right- and left-side covers](#))
 - Interface cover (see [Interface cover](#))
 - Formatter cage (see [Formatter assemblies](#))
 - Back cover (see [Back cover](#))
 - Top cover (see [Top cover](#))
2. Disconnect one connector (callout 1, hidden, is the connector to the main motor).
3. Disconnect two connectors (callout 2) from the dc controller.

Note

The dc controller has been removed from the printer in [Figure 5-35. Removing the gear assembly \(1 of 2\)](#). If it were not, then the connectors in callout 2 would still be attached to the dc controller.

Reinstallation tip

The connectors in callout 2 can become lost behind the dc controller upon reinstallation of the dc controller.

- Pinch the cable holder (callout 3) and then unwind the cable.

CAUTION

Do not attempt to disconnect the clutch cable from the clutch. Doing so can damage the cable.

- Remove the e-clip (callout 4) from the clutch, and then pull the clutch away from the printer.
- From inside the printer, press the small tab on the gear (see callout 1 in [Figure 5-20. Removing the top cover \(1 of 2\)](#)) to disengage the inside and outside gears (callout 5) from each other.

Note

To reinstall the gear, lower the vertical rack (callout 6) to its lowest position, and then align the gear with the vertical rack.

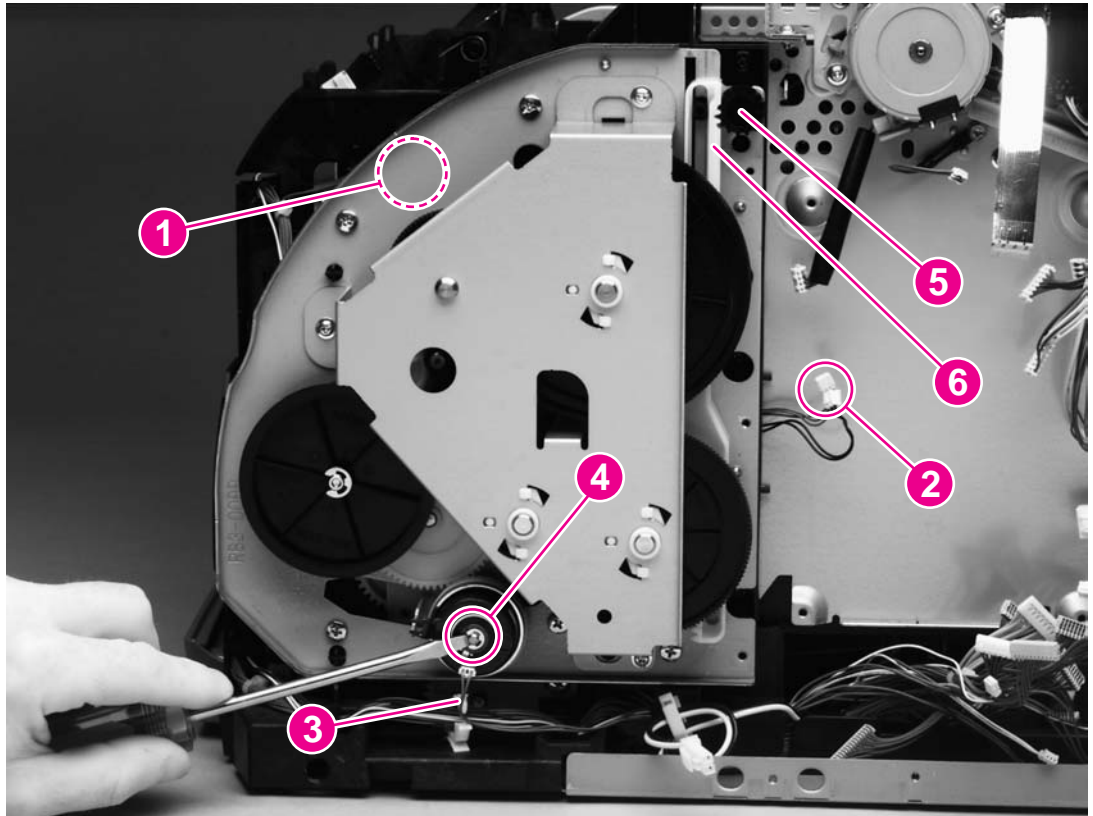

Figure 5-35. Removing the gear assembly (1 of 2)

Note

The clutch cable routing in more recent versions of the printer is different from the routing shown in [Figure 5-35. Removing the gear assembly \(1 of 2\)](#). Examine the routing to make sure that it is reinstalled correctly.

- Remove eight screws (callout 7) from the gear plate.

8. Rotate the gear assembly away from the printer, beginning with the front edge.

Note

A grounding spring (callout 8, hidden) should remain attached to the printer chassis. If it does not, then either reattach it to the chassis or place it with the gear assembly to prevent misplacing it.

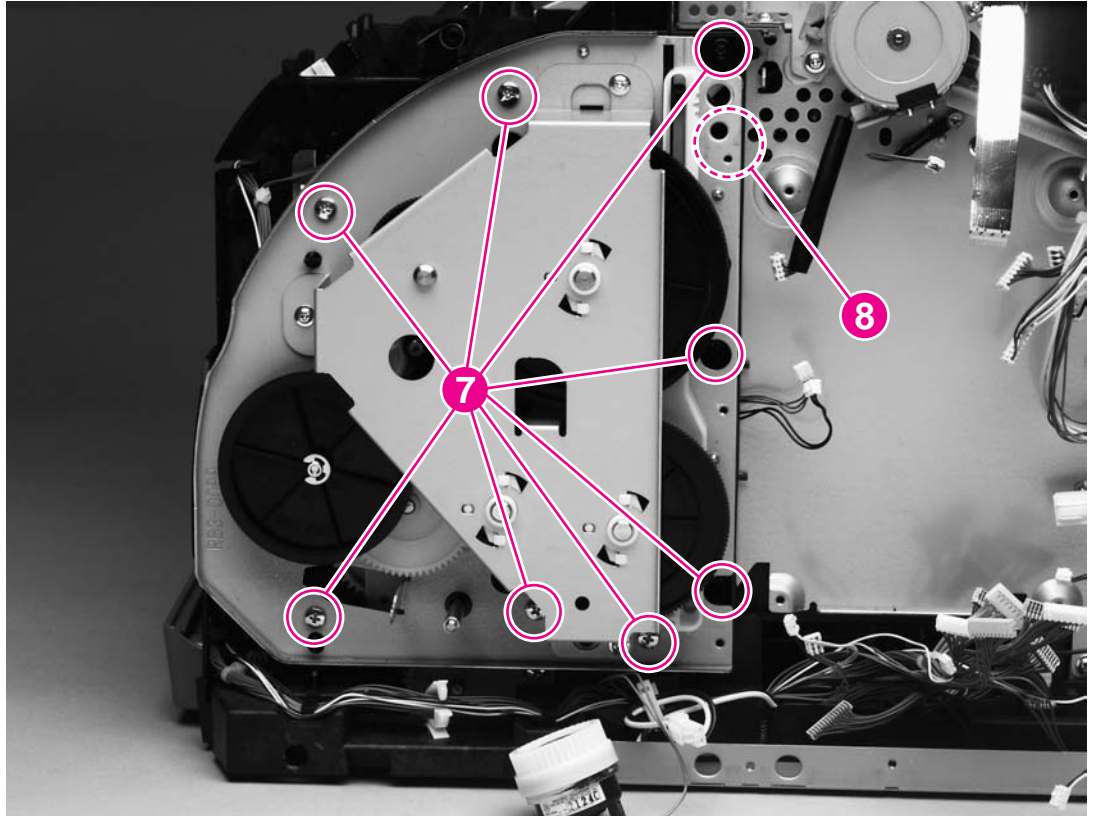

Figure 5-36. Removing the gear assembly (2 of 2)

Reinstallation tip

A grounding wire at the lower-back corner of the gear assembly must be hooked around the chassis at reinstallation. Callout 2 in [Figure 5-37. Removing the waste-toner sensor](#) shows the grounding wire, and callout 3 shows the grounding spring attached to the chassis.

Align the following parts with the printer chassis:

- gear assembly shaft
- grounding spring
- grounding wire

Waste-toner sensor

1. Unroute the cable from several cable holders.
2. Remove one screw (callout 1).

3. Lift the waste-toner sensor away from the printer.

Note

Callout 2 shows the grounding wire that must be hooked around the printer chassis upon reinstallation of the gear assembly. Callout 3 shows the grounding spring.

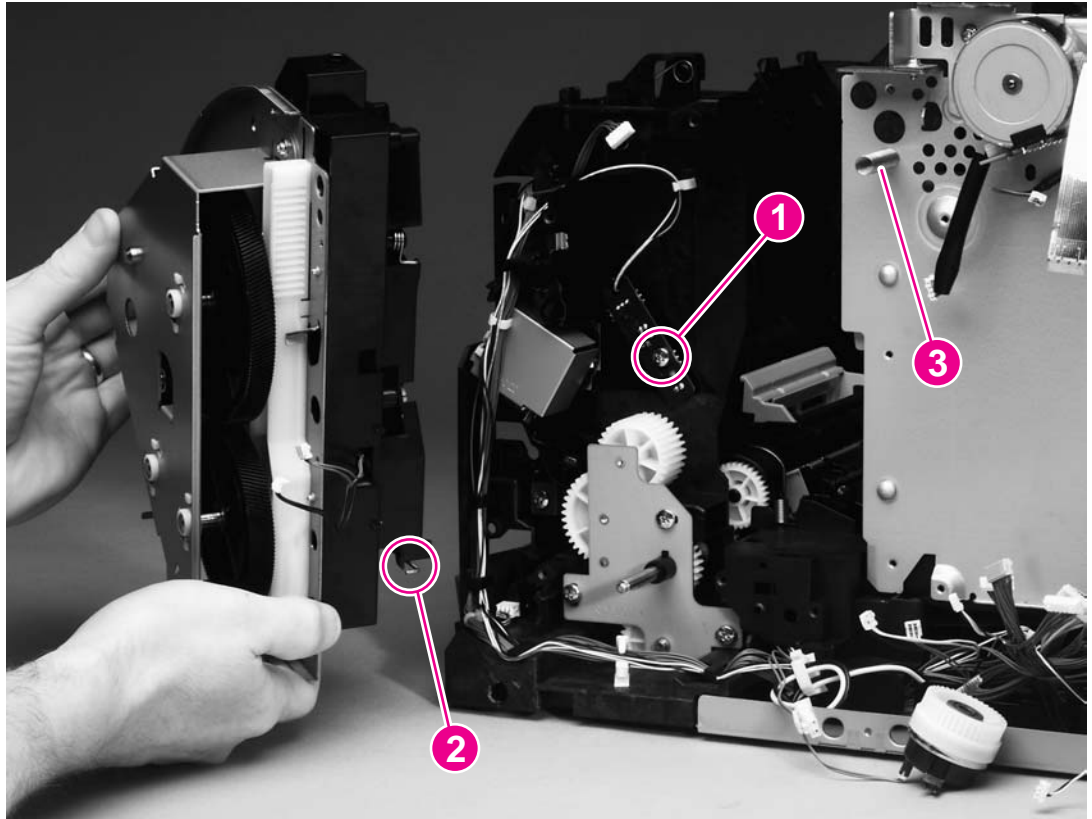

Figure 5-37. Removing the waste-toner sensor

Rotary-drive assembly

Note

The rotary-drive assembly includes the developer motor, the brake solenoid, and the encoder motor.

1. Remove the following covers and assembly:
 - Right- and left-side covers (see [Right- and left-side covers](#))
 - Interface cover (see [Interface cover](#))
 - Formatter cage (see [Formatter assemblies](#))
 - Back cover (see [Back cover](#))
 - Top cover (see [Top cover](#))

2. Unplug three cable connectors (callout 1) from the dc controller and unplug the flat laser/scanner cable (callout 2) from the laser/scanner.

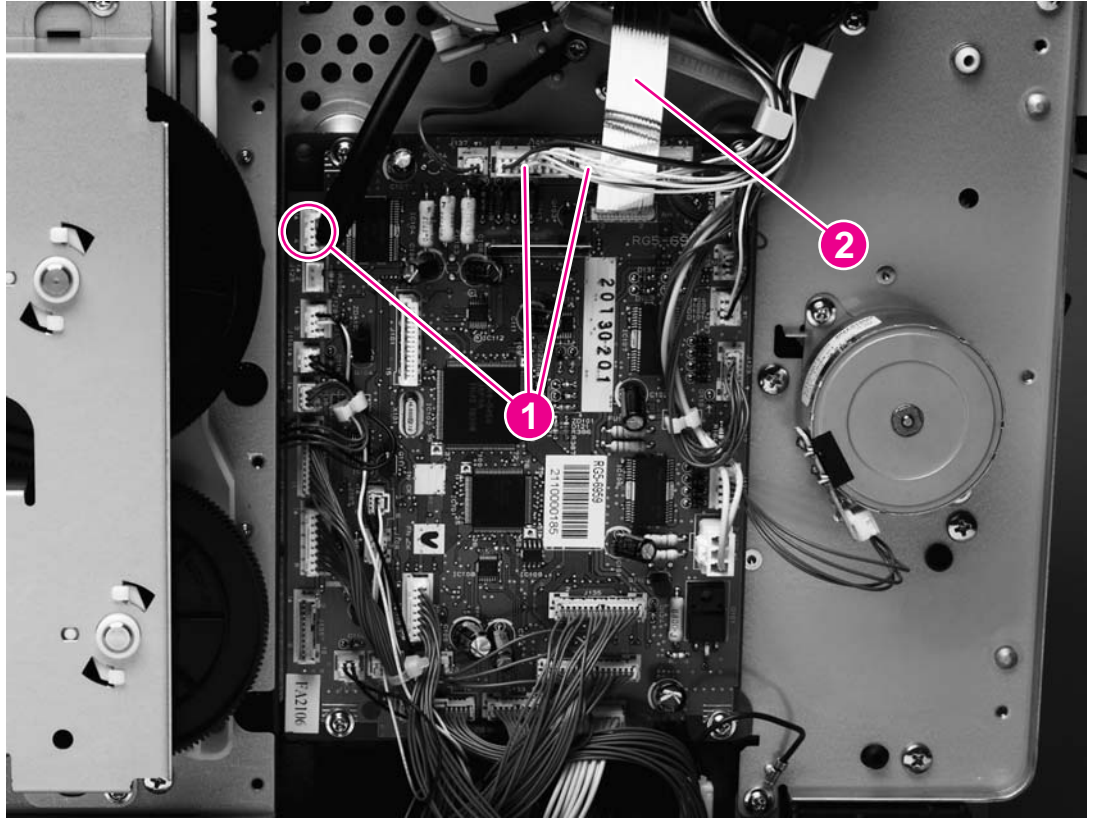

Figure 5-38. Removing the rotary-drive assembly (1 of 3)

3. Remove one screw (callout 3) from the motor.

4. Remove one of the four screws that secures the rotary-drive assembly to the chassis (callout 4).

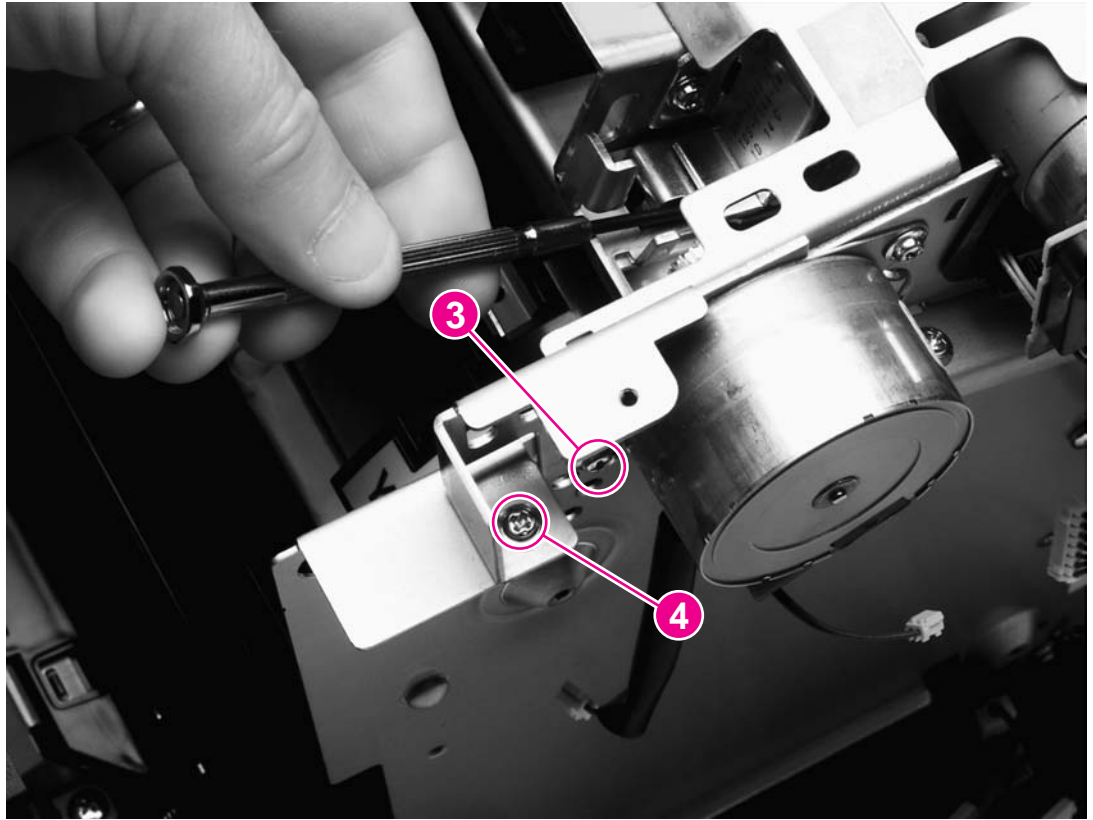

Figure 5-39. Removing the rotary-drive assembly (2 of 3)

5. Face the top of the printer, and remove the other three screws that secure the rotary-drive assembly to the chassis (callout 5).

6. Unplug five connectors (callout 4) from the dc controller.

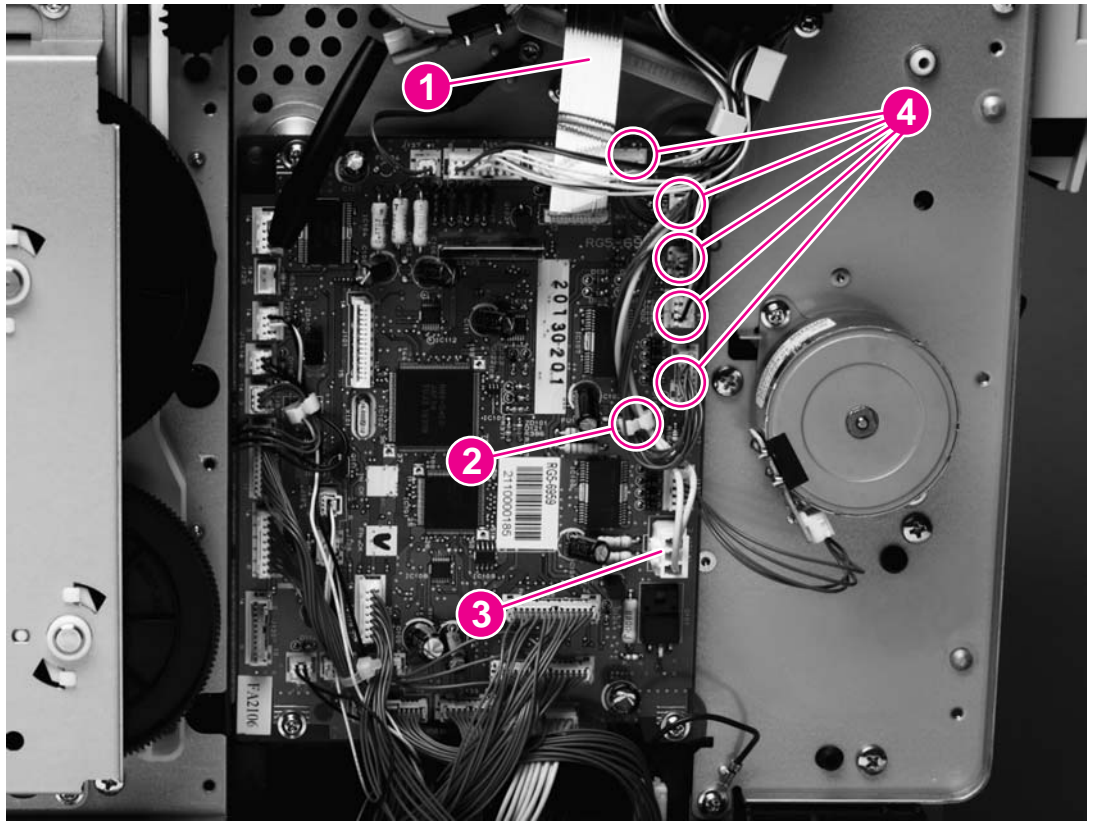

Figure 5-41.

Removing the top plate (1 of 3)

7. Unroute two cables (callout 5).

Note

Examine the routing of the cables. If the cables are not reinstalled to their correct routing, then the cables can become pinched by other assemblies.

8. Unplug two connectors (callout 6).

- Remove two screws at the left side of the printer (callout 7) and then remove the two corresponding screws from the right side of the printer.

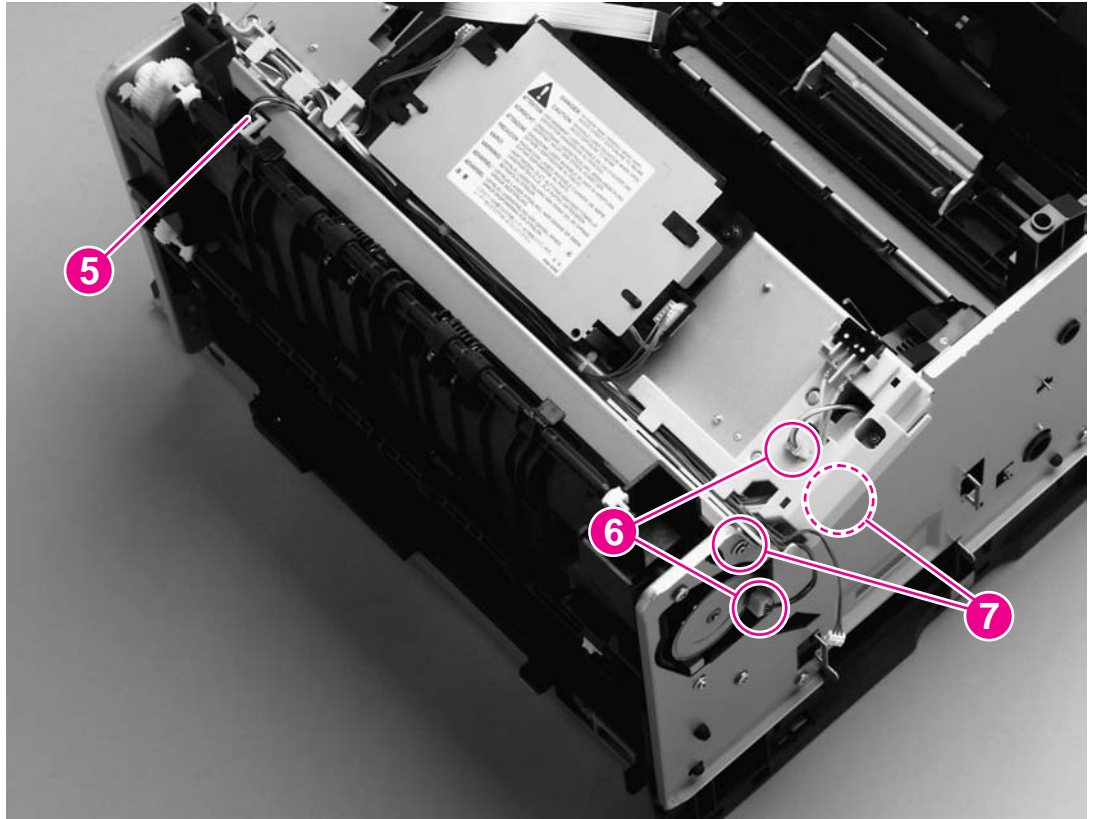

Figure 5-42.

Removing the top plate (2 of 3)

Reinstallation tip

The "hidden" screw in callout 7 secures a grounding plate (callout 8) to the chassis. Removing the screw releases the grounding plate. Upon reinstallation of the top plate, make sure that the grounding plate tab is in its correct position on the outside of the carousel drive shaft.

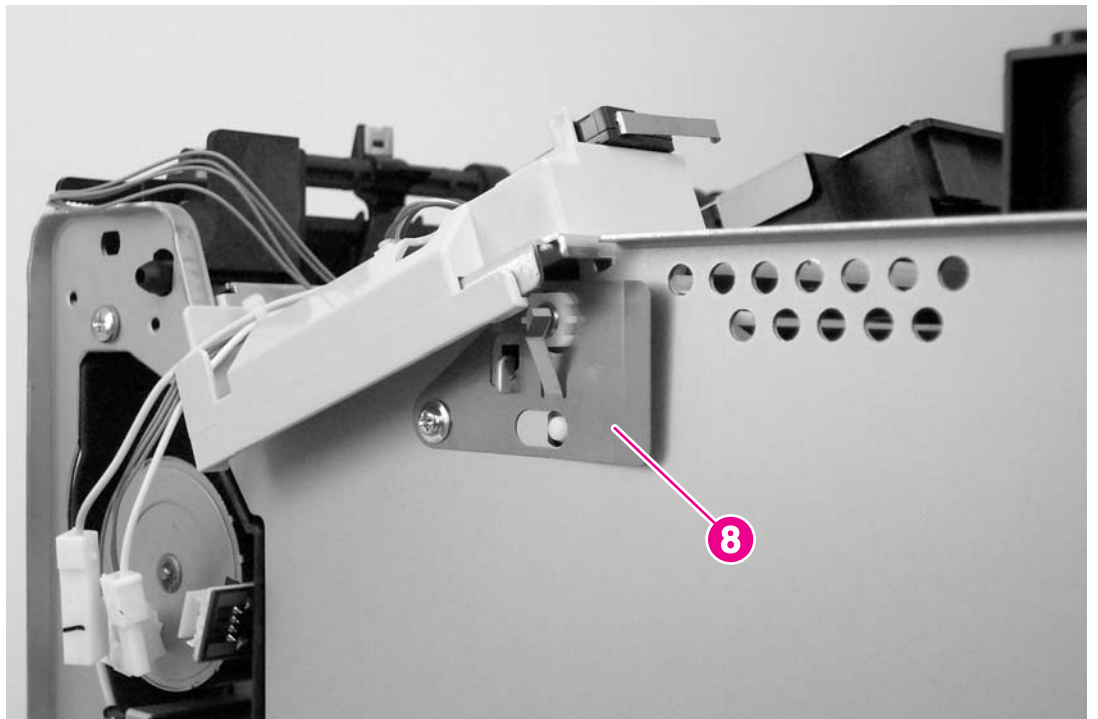

Figure 5-43.

Reinstalling the grounding plate

10. Remove four screws (callout 9) from the top plate.

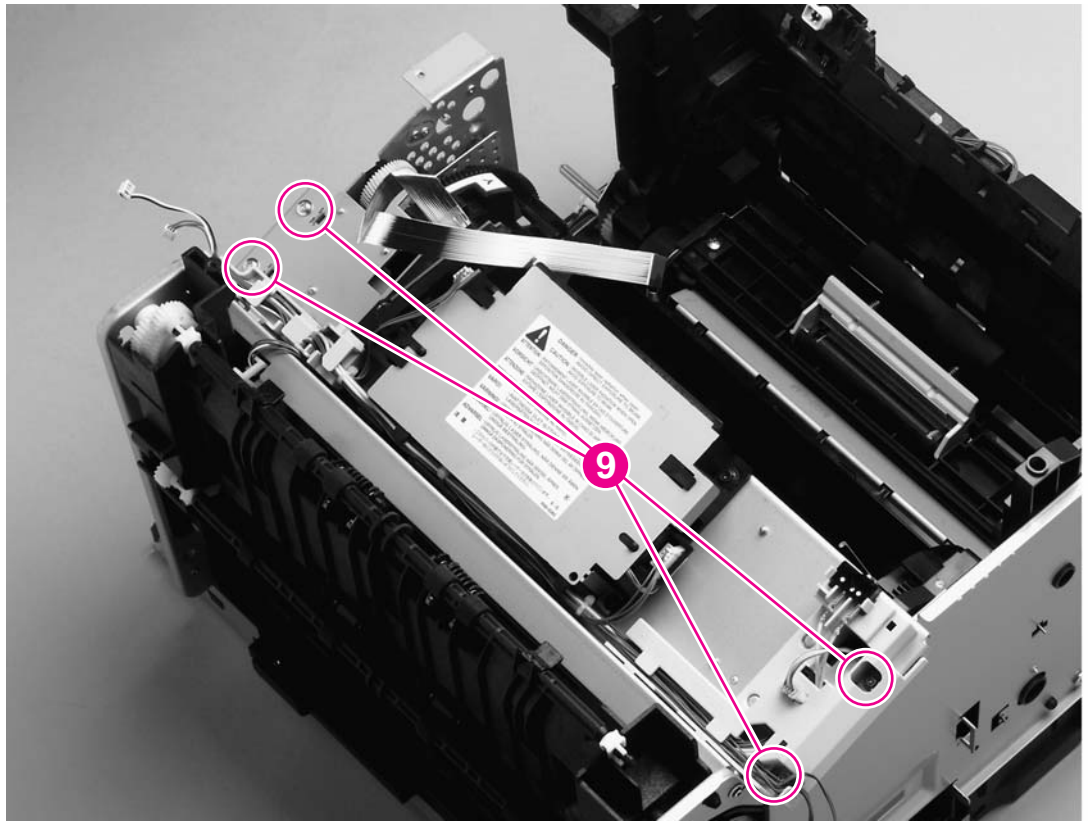

Figure 5-44.

Removing the top plate (3 of 3)

11. Carefully lift the top plate off of the printer frame.

Print-cartridge carousel

1. Remove the following covers and assemblies:
 - Right- and left-side covers (see [Right- and left-side covers](#))
 - Interface cover (see [Interface cover](#))
 - Formatter cage (see [Formatter assemblies](#))
 - Back cover (see [Back cover](#))
 - Top cover (see [Top cover](#))
 - Air duct (see [Air duct and fan](#))
 - Rotary-drive assembly (see [Rotary-drive assembly](#))
 - Top plate (see [Top plate](#))

2. Remove two screws (callout 1) from the back of the printer.

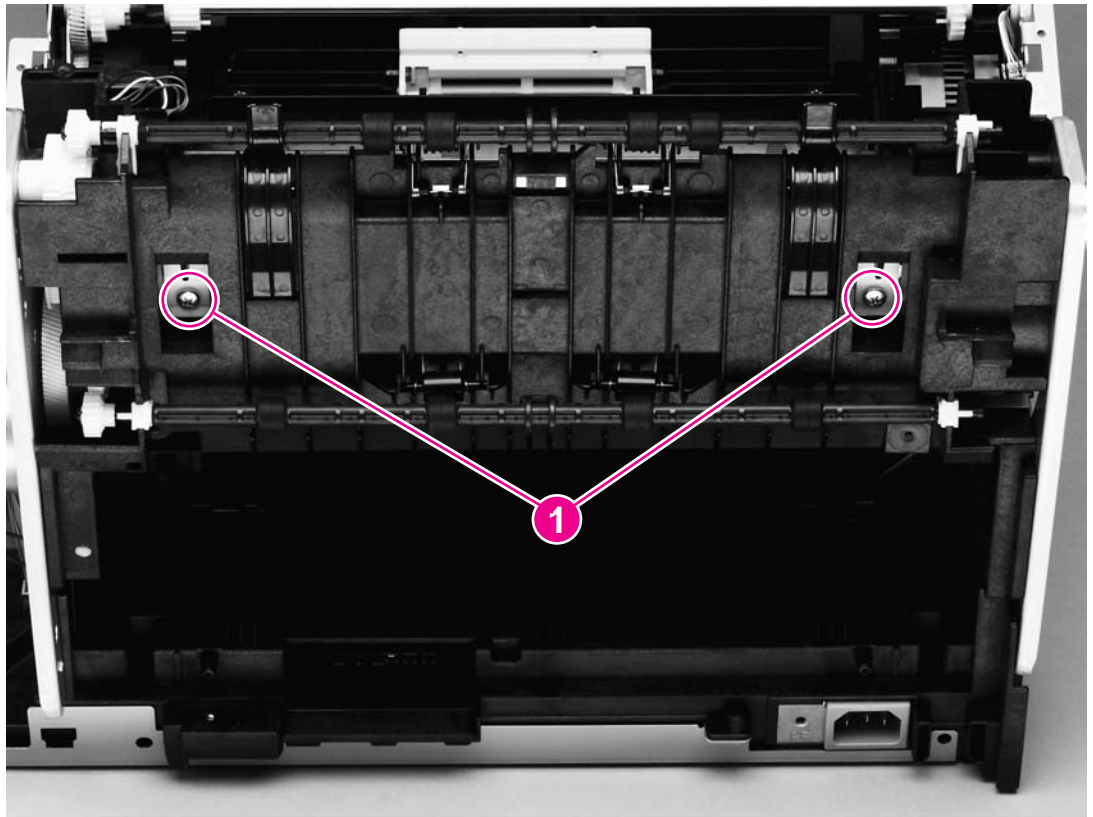

Figure 5-45.

Removing the print-cartridge carousel (1 of 3)

Reinstallation tip

Because the remainder of the print-cartridge carousel removal procedures are performed from the left, right, and front of the printer, it is easy to forget to replace the two screws at the back of the printer.

3. Press the white plastic tab (callout 2) at the left side of the printer to release the left swing-shaft bushing, and then rotate the bushing to a vertical position.

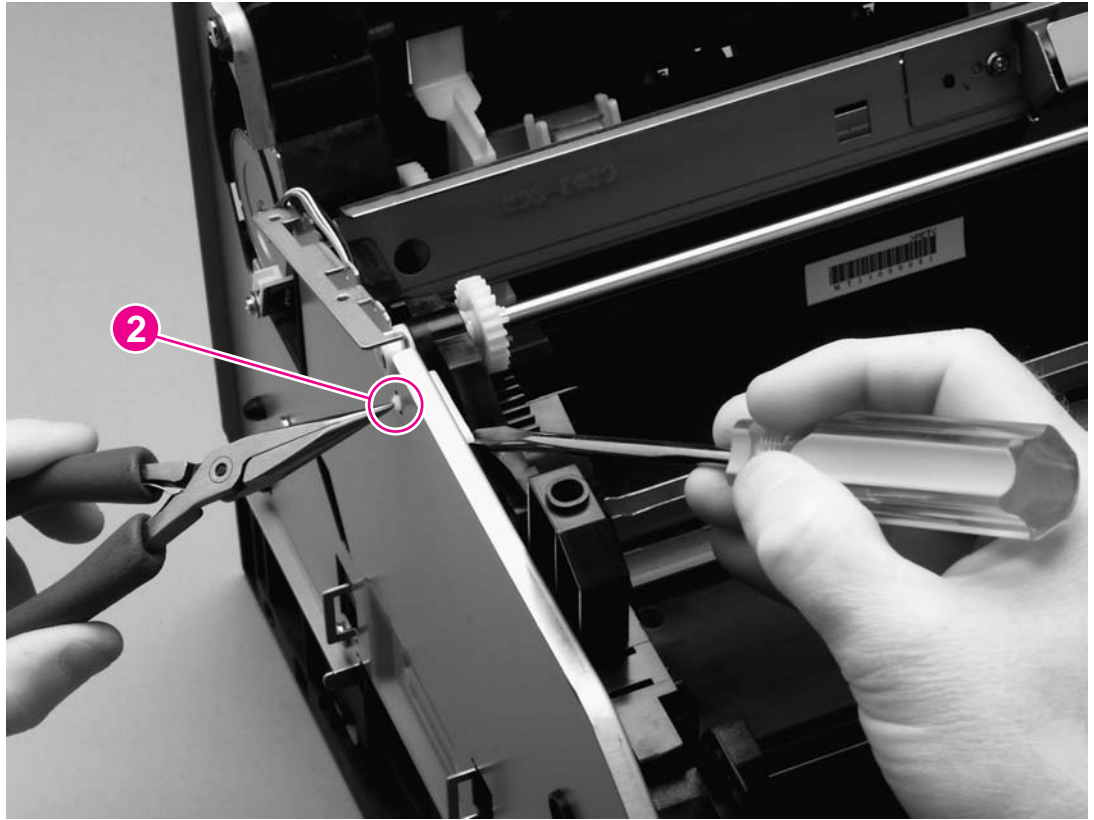

Figure 5-46.

Removing the print-cartridge carousel (2 of 3)

4. On the right side of the printer, repeat step 3 on the right swing-shaft bushing.

Examine the positions of the left pressure-shaft holder (callout 3), the right pressure-shaft holder (callout 4), and the pressure-shaft gear (callout 5) before you perform step 5. The pressure-shaft holders must be reinstalled to their correct positions when reinstalling the print-cartridge carousel.

5. Use the flatblade screwdriver to pry two white tabs on the pressure-shaft holders from their seated positions in the rear frame assembly.

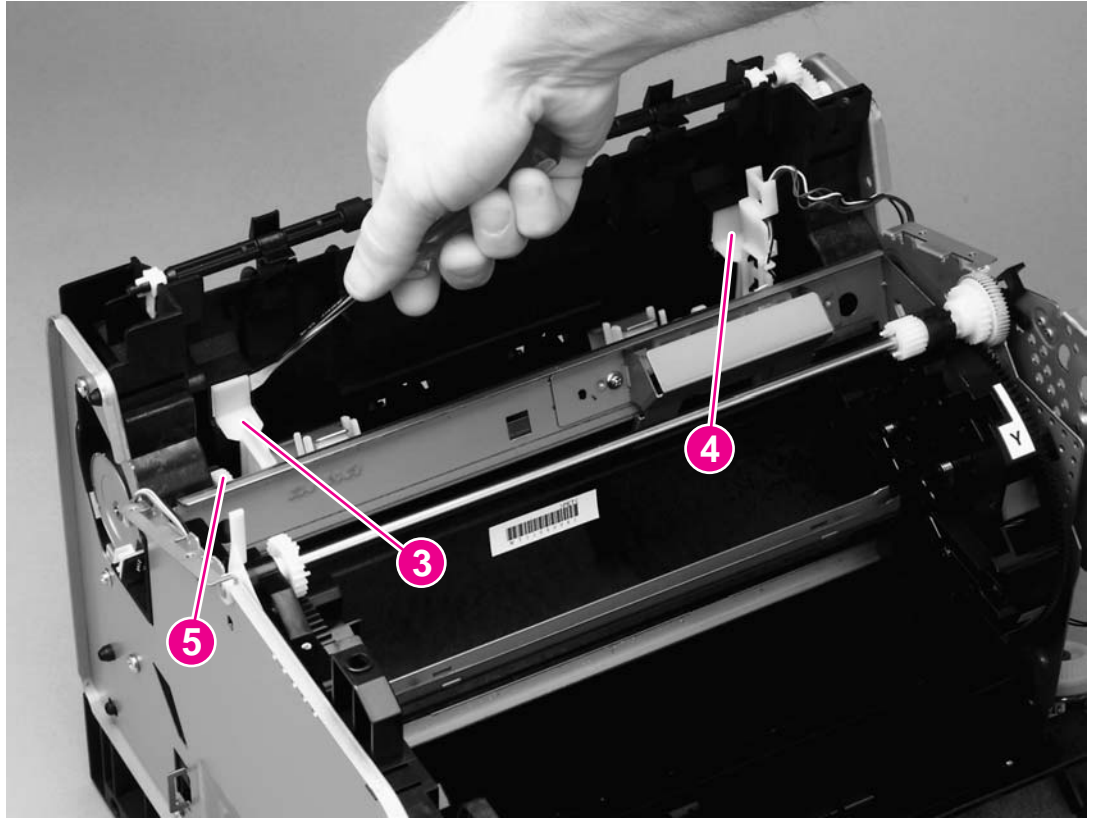

Figure 5-47.

Removing the print-cartridge carousel (3 of 3)

6. Lift the print-cartridge carousel out of the printer.

Reinstallation tip

Make sure that the "feet" of the pressure-shaft holders fit into the slots in the rear frame assembly. After the "feet" are reinstalled correctly, press the tops of the white tabs firmly into position.

Incorrect reinstallation of the "feet" is shown, followed by correct installation.

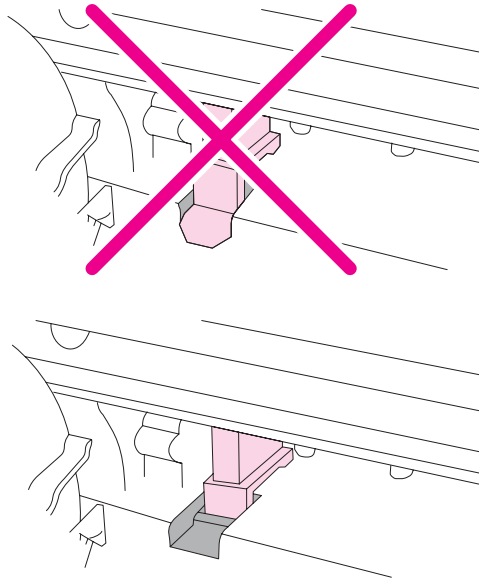

Also make sure that the tab on the pressure-shaft gear points down.

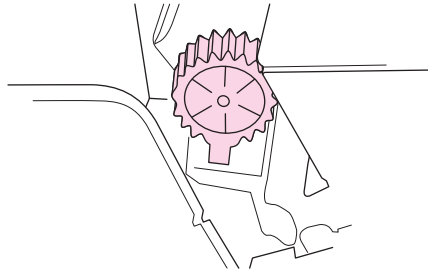

Aligning the carousel gears

Make sure that the gears in the print-cartridge carousel are aligned correctly before placing the carousel back into the printer.

1. Rotate the carousel so that the marker for the yellow print cartridge faces the front of the printer.
2. Examine the gears: two marks on the smaller gear should line up with the single mark on the larger gear (see the detail of the gears in [Figure 5-48. Reinstalling the print-cartridge carousel](#)).

Note

The single mark on the larger gear is adjacent to the slot for the black cartridge, marked with a "K."

3. If the gears are not aligned correctly, locate the marks on the gears and realign the gears.

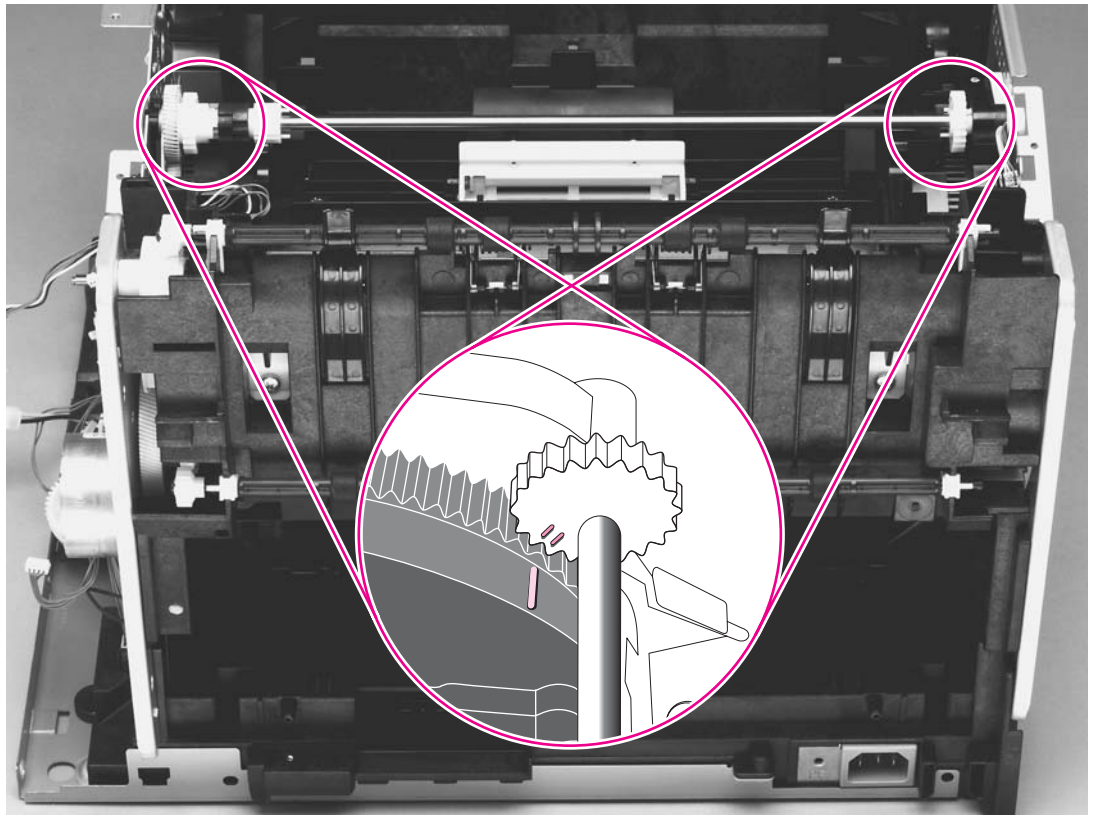

Figure 5-48.

Reinstalling the print-cartridge carousel

Registration-roller assembly

1. Remove two screws (callout 1) from the registration-shutter assembly.

2. Rotate the registration-roller assembly toward the front of the printer and then lift it towards the rear of the printer and up to remove it from the printer.

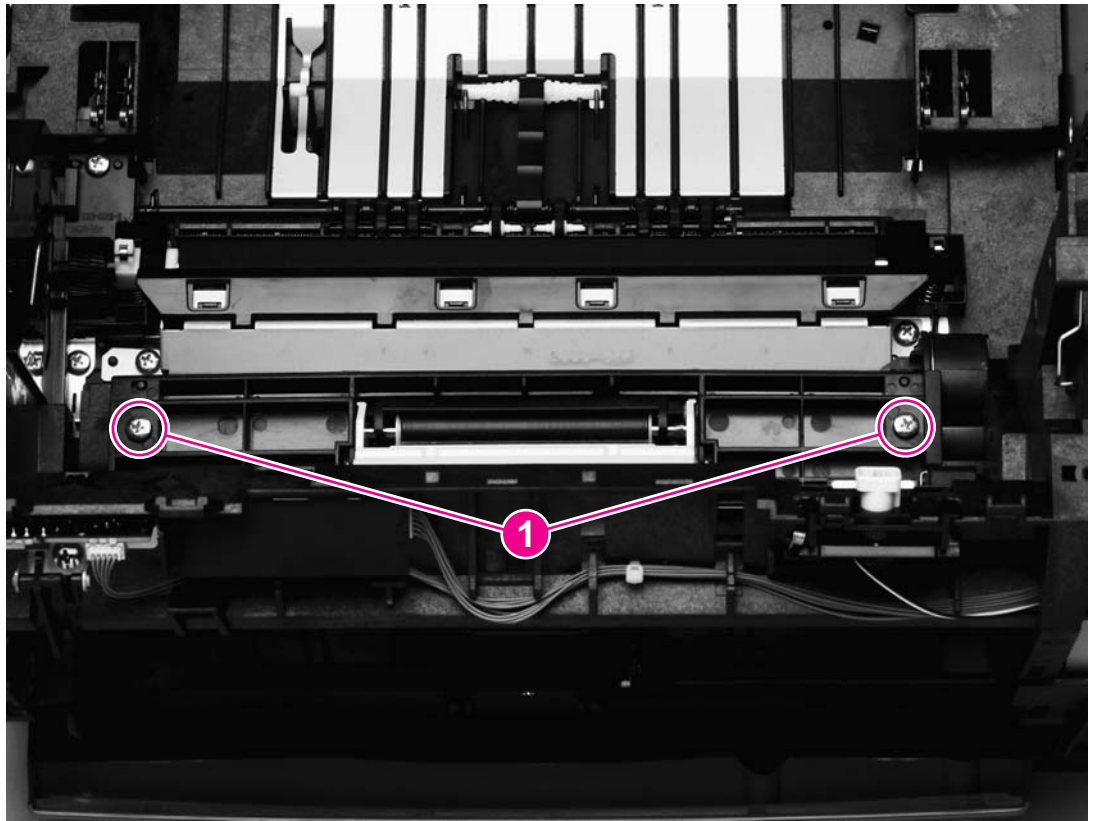

Figure 5-49. Removing the registration-roller assembly

Toner-catch tray

The toner-catch tray is secured by two tabs underneath the tray (see [Figure 5-50. Removing the toner-catch tray](#)), toward the front of the tray.

1. Release one tab on either side of the toner-catch tray and then pull the tray approximately 2 or 3 mm (approximately 0.125 inch) toward the front of the printer to make sure that the tab does not reseat as you perform step 2.
2. Release the tab on the other side and then lift the tray out of the printer.

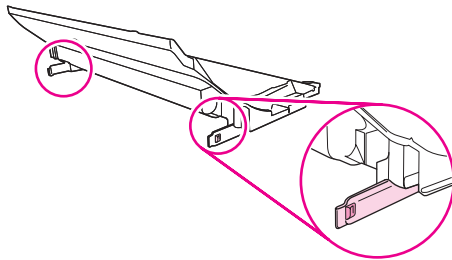

Figure 5-50. Removing the toner-catch tray

Transfer-roller plate

CAUTION

Do not touch the black sponge portion of the transfer roller.

1. Remove the toner-catch tray (see [Toner-catch tray](#)).
2. Remove two screws (callout 1) from the transfer-roller plate.
3. Lift the transfer-roller plate straight up to remove it from the printer.

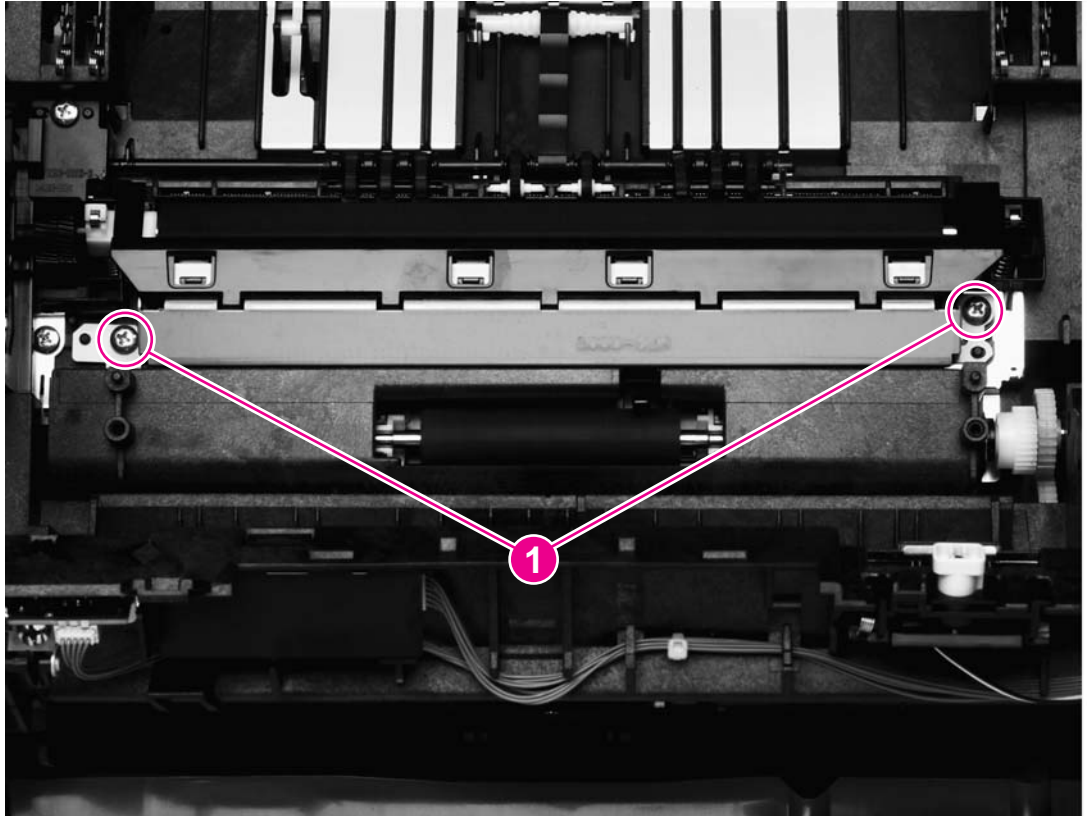

Figure 5-51. Removing the transfer-roller plate

Transfer roller

CAUTION

Do not touch the black sponge portion of the transfer roller.

1. Remove the following assemblies:
 - Toner-catch tray (see [Toner-catch tray](#))
 - Transfer-roller plate (see [Transfer-roller plate](#))
2. Use needle-nose pliers to gently squeeze the small tabs at the right side of the transfer roller (see the detail in [Figure 5-52. Removing the transfer roller](#)) and then also squeeze the tabs at the left side of the transfer roller to release the roller.

Note

Be careful not to bend the thin metal strip adjacent to the tabs on the right side of the roller.

3. Lift the transfer roller up from the right side, slide it to the right, and lift it out of the printer.

Note

The small grounding spring that is underneath the left side of the transfer roller is attached to the transfer roller. It is removed with the transfer roller.

The small grounding spring that is underneath the right side of the transfer roller remains in the chassis.

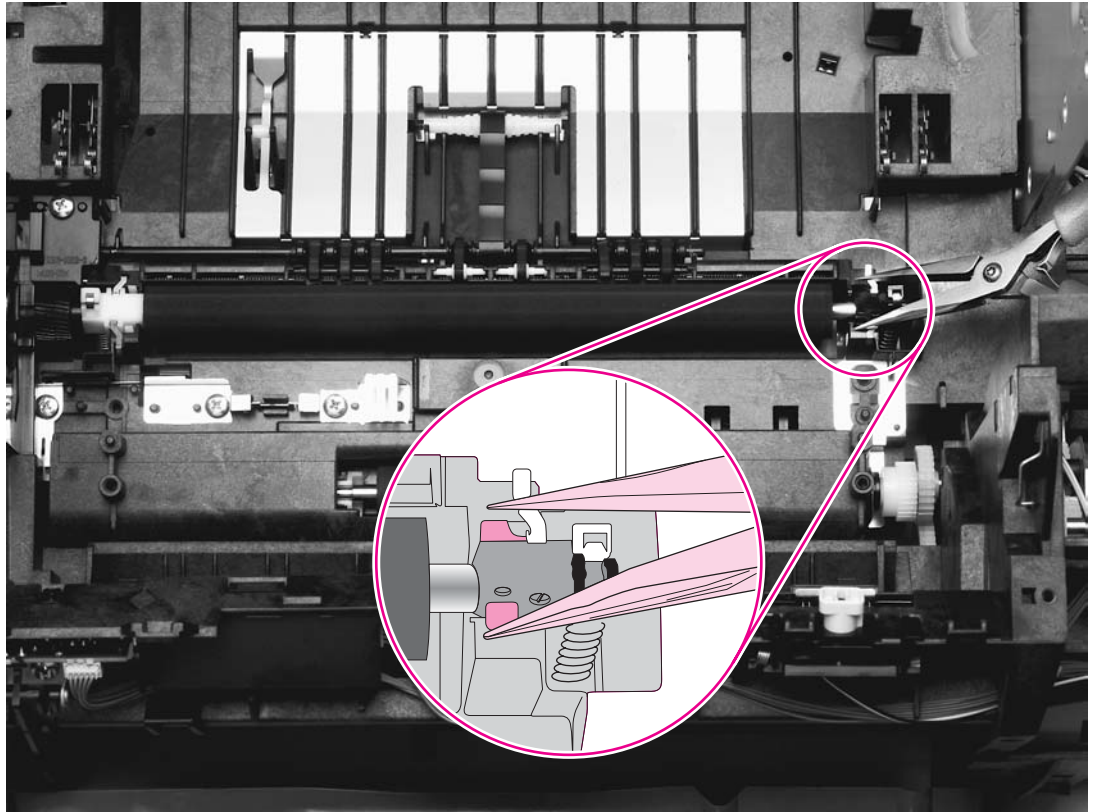

Figure 5-52. Removing the transfer roller

Feed-drive shaft

1. Remove the following covers and assemblies:
 - Right- and left-side covers (see [Right- and left-side covers](#))
 - Toner-catch tray (see [Toner-catch tray](#))
 - Transfer-roller plate (see [Transfer-roller plate](#))
 - Transfer roller (see [Transfer roller](#))
2. Remove one screw (callout 1) from the gear cover, and then lift the gear cover to remove it.
3. Lift the belt roller (callout 2) from its hooks.
4. Use a small flatblade screwdriver to slide the clip toward the back of the printer, and then pry the feed-drive shaft (callout 3) off of the hooks that secure it to the printer.

Note

Unless the feed-drive shaft itself is damaged, there is no need to remove the shaft.

5. Use a small flatblade screwdriver to pry four pulleys (callout 4) from their hooks.

- After the feed-drive shaft and the pulleys are released, remove the timing belt (callout 5) and the small feed belts by sliding them off of the right end of the feed-drive shaft.

Note

Callout 6 shows the roller on the fuser wrap-jam sensor. The roller must be removed first if you want to remove the ECU pan (the bottom plate of the printer).

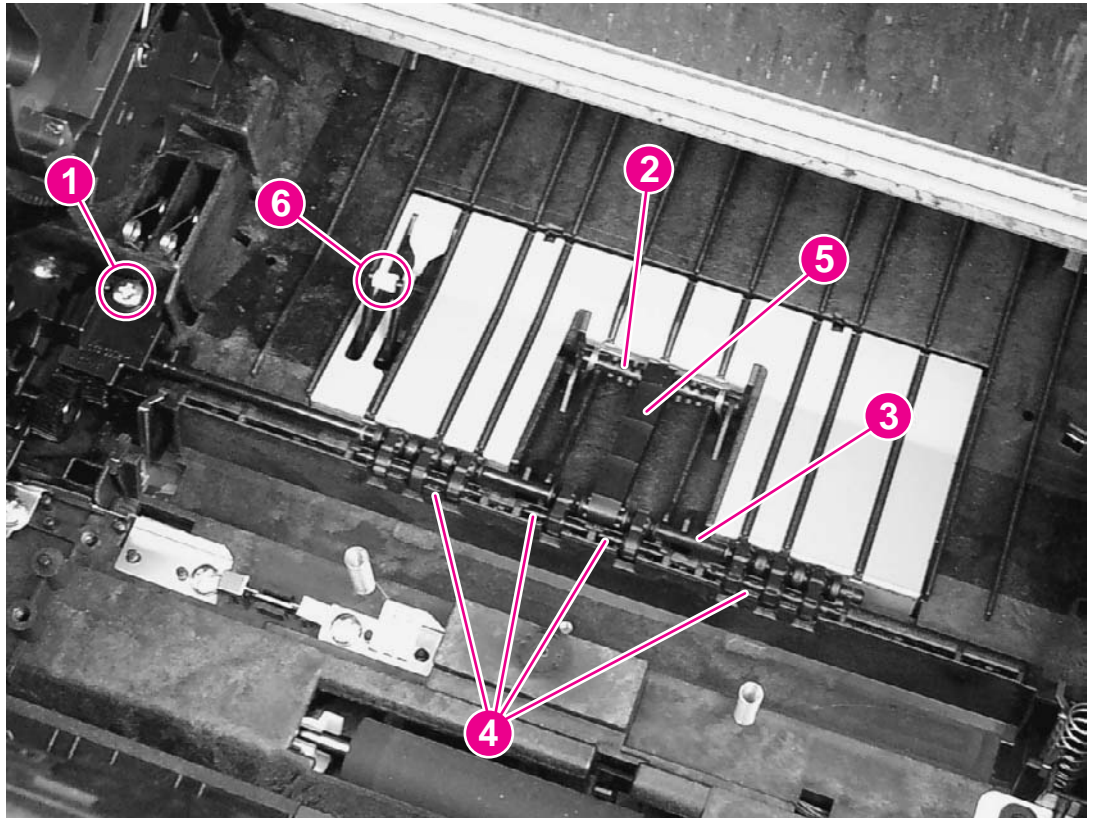

Figure 5-53. Removing the feed-drive shaft

Reinstallation tip

Examine the timing belt (callout 5) before removing it from the printer. The leading and trailing sides of the ridges are different and the belt must be reinstalled correctly to prevent media-feed problems.

ECU pan

- Remove the following covers and assemblies:
 - Right- and left-side covers (see [Right- and left-side covers](#))
 - Interface cover (see [Interface cover](#))
 - Formatter cage (see [Formatter assemblies](#))
 - Optional tray 2 (see [Optional tray 2 \(250-sheet tray\)](#))
 - Toner-catch tray (see [Toner-catch tray](#))
- Unplug five cable connectors (callout 1) from the dc controller.

3. Remove one screw (callout 2) from the grounding wire.

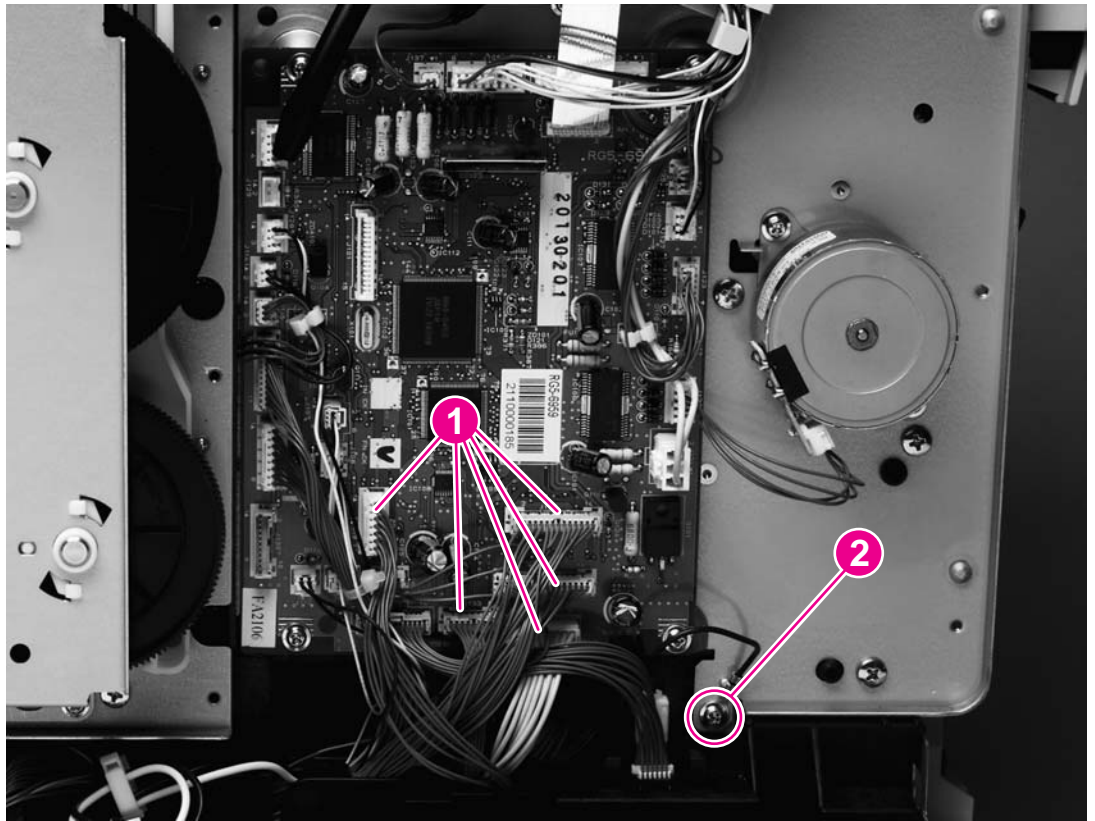

Figure 5-54.

Removing the ECU pan (1 of 2)

4. Turn the printer over so that it rests on its top.
5. Remove one screw from the left side of the printer (callout 3)
6. Remove eight screws (callout 4) from the bottom of the ECU pan.

7. Lift the ECU pan off of the printer.

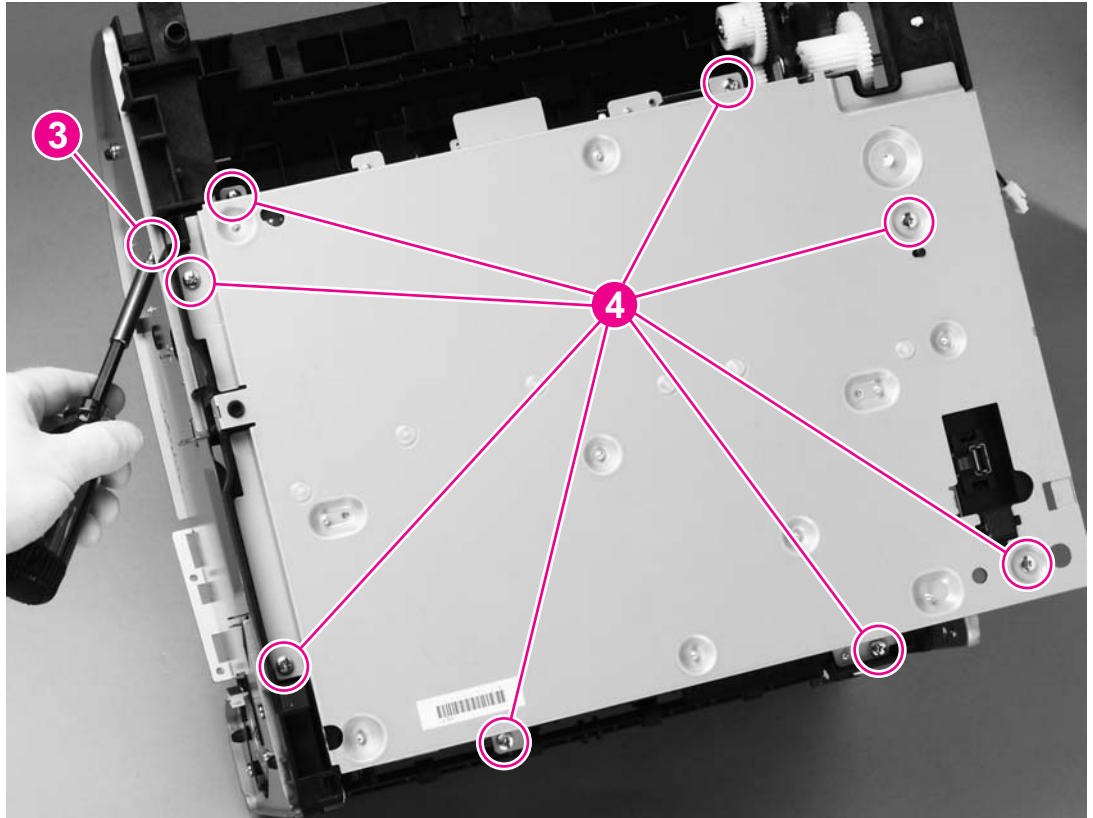

Figure 5-55.

Removing the ECU pan (2 of 2)

Reinstallation tip

Make sure that the grounding springs are attached to each of the eight ECU connections before reinstalling the ECU pan.

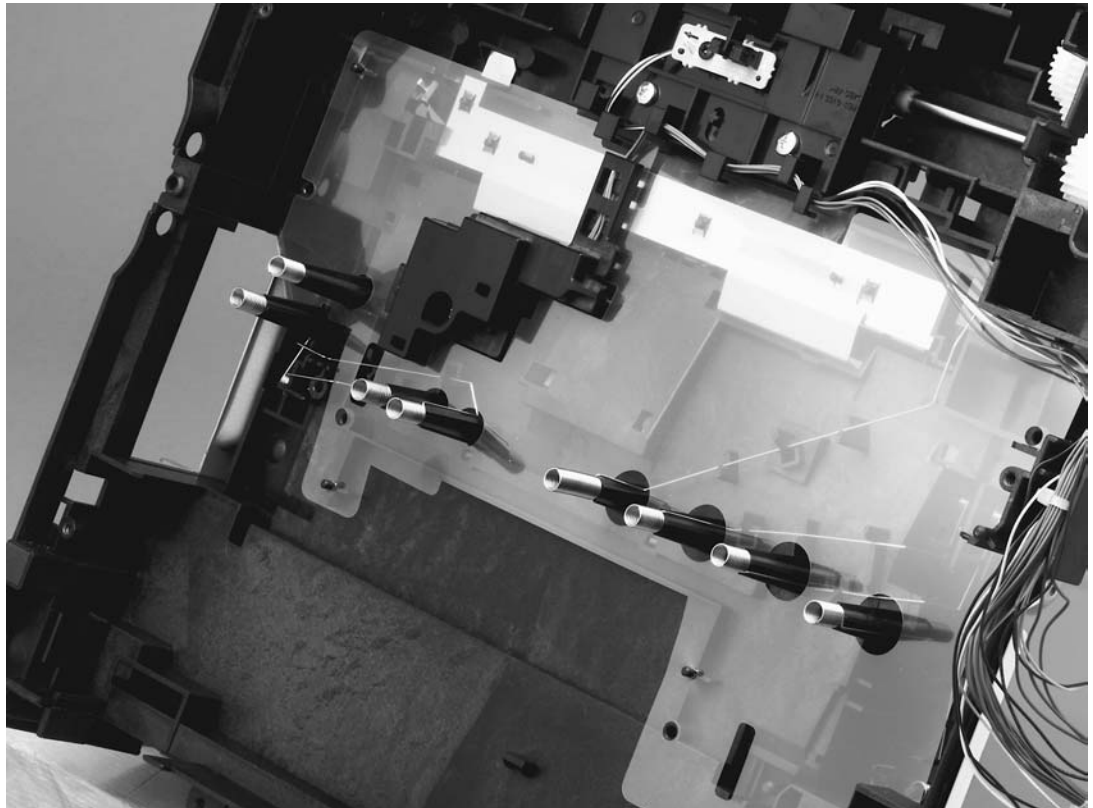

Figure 5-56.

ECU connections

Sub-high-voltage transformer PCA

1. Remove the following covers and assemblies:
 - Right- and left-side covers (see [Right- and left-side covers](#))
 - Optional tray 2 (see [Optional tray 2 \(250-sheet tray\)](#))
 - Fuser (see [Fuser cover \(and fuser\)](#))
 - ECU pan
2. Unplug one connector (callout 1) from the high-voltage transformer PCA.
3. Remove two screws (callout 2).
4. Lift up the sub-high-voltage transformer PCA and its holder, and then unplug one connector (callout 3) from the high-voltage transformer PCA.

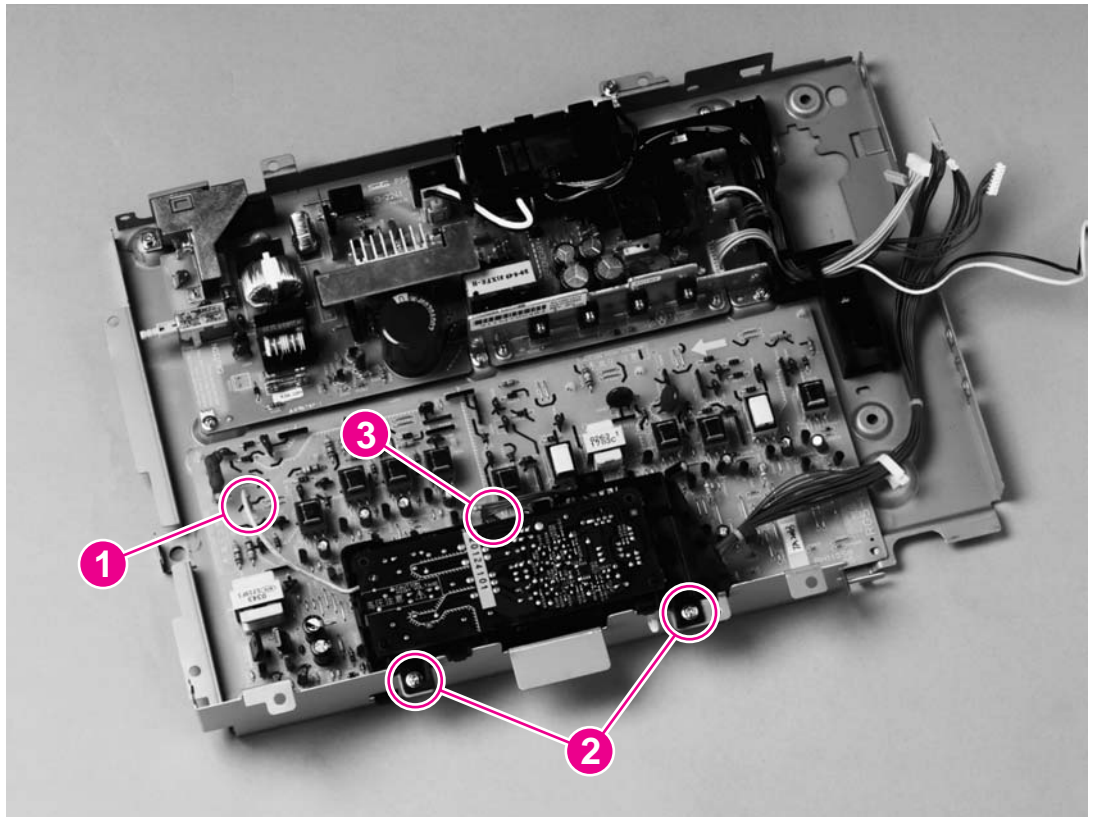

Figure 5-57. Removing the sub-high-voltage transformer PCA

High-voltage transformer PCA

1. Remove the following covers and assemblies:
 - Right- and left-side covers (see [Right- and left-side covers](#))
 - Interface cover (see [Interface cover](#))
 - Formatter cage (see [Formatter assemblies](#))
 - Optional tray 2 (see [Optional tray 2 \(250-sheet tray\)](#))
 - ECU pan (see [ECU pan](#))
 - sub-high-voltage transformer PCA (see [Sub-high-voltage transformer PCA](#))
2. Release two cable holders (callout 1) and then unplug two connectors (callout 2).
3. Remove two screws (callout 3).
4. Pinch six plastic pins (callout 4) and then lift the high-voltage transformer PCA off of the ECU pan.

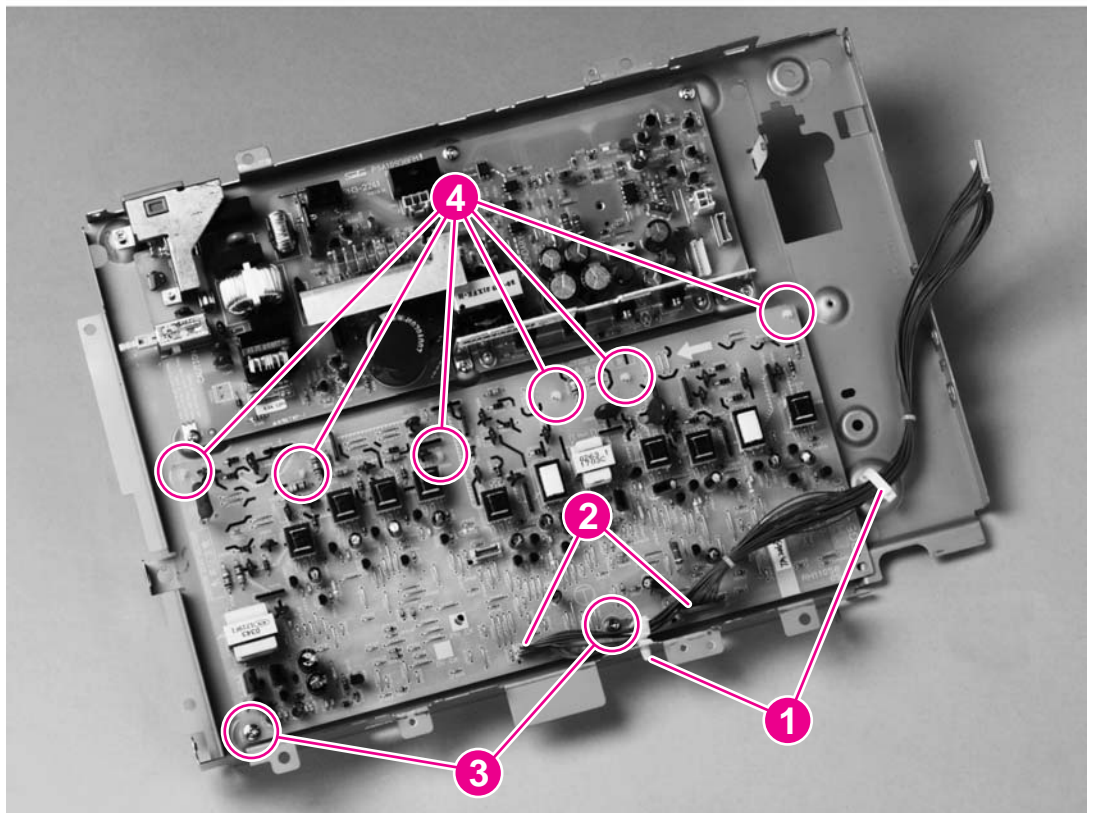

Figure 5-58. Removing the high-voltage transformer PCA

Low-voltage PCA

1. Remove the following covers and assemblies:
 - Right- and left-side covers (see [Right- and left-side covers](#))
 - Interface cover (see [Interface cover](#))
 - Formatter cage (see [Formatter assemblies](#))
 - Optional tray 2 (see [Optional tray 2 \(250-sheet tray\)](#))
 - ECU pan (see [ECU pan](#))
2. Unplug four connectors (callout 1) from the low-voltage PCA.
3. Remove one screw (callout 2) from the grounding wire.
4. Remove two screws (callout 3) from the fuser-connector holder and lift the holder off of the low-voltage PCA.

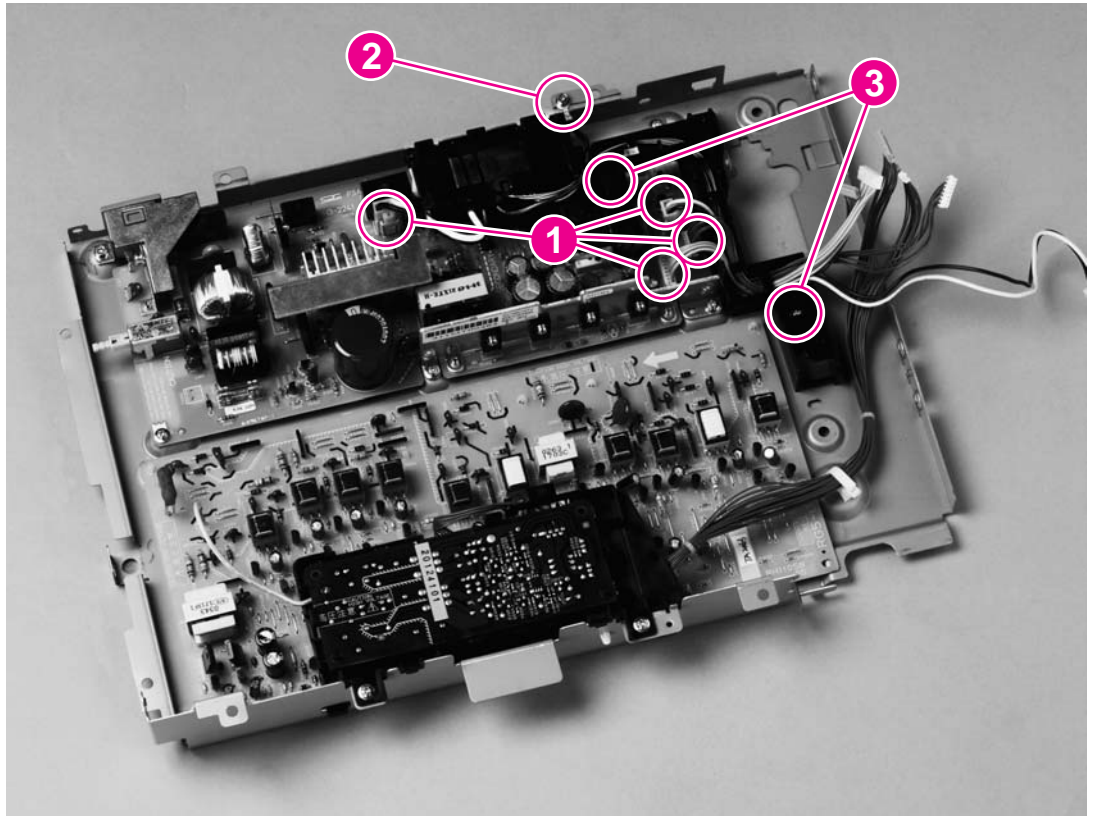

Figure 5-59. Removing the low-voltage PCA (1 of 2)

5. Remove six screws (callout 4) from the low-voltage PCA, and then lift the PCA off of the ECU pan.

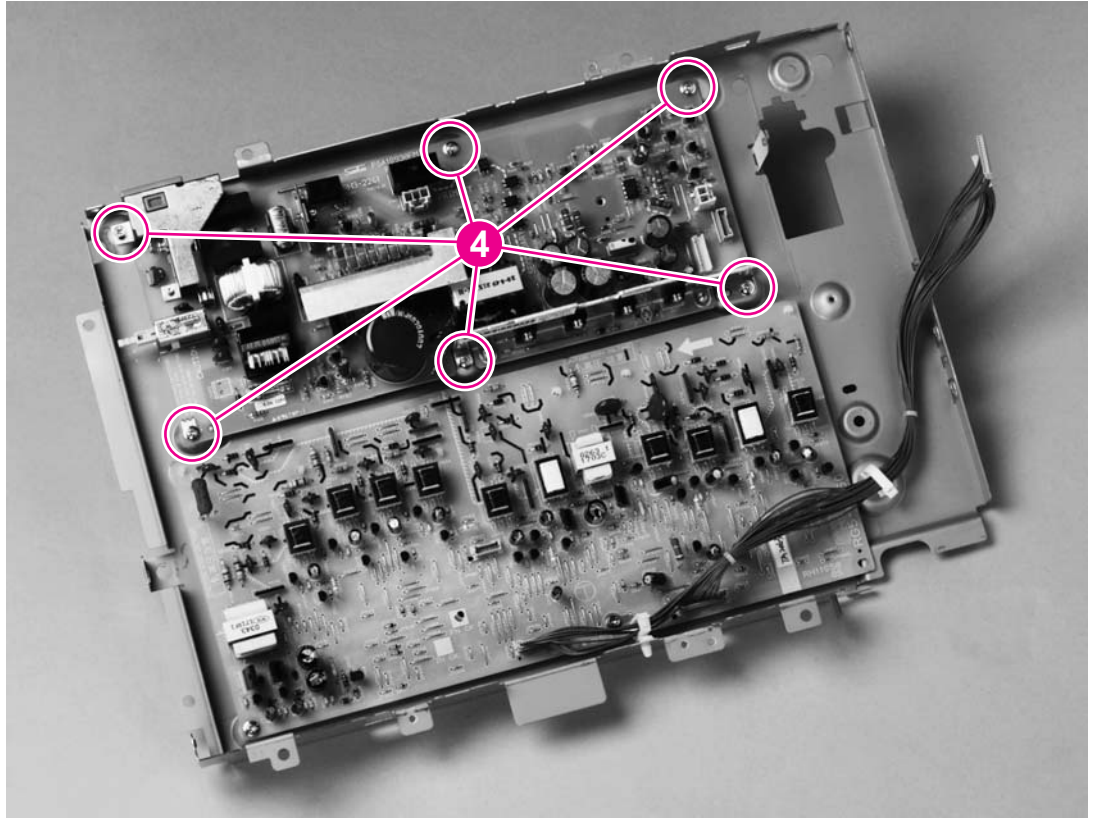

Figure 5-60. Removing the low-voltage PCA (2 of 2)

Paper-top sensor

1. Remove the ECU pan (see [Front cover](#)).
2. Remove one screw (callout 1).
3. Lift the paper-top sensor straight up to remove it from the printer.

4. Unwind the cable from the cable harness, and unplug the cable from the dc controller.

CAUTION

Do not attempt to disconnect the paper-top sensor cable from the paper-top sensor. Doing so can damage the cable.

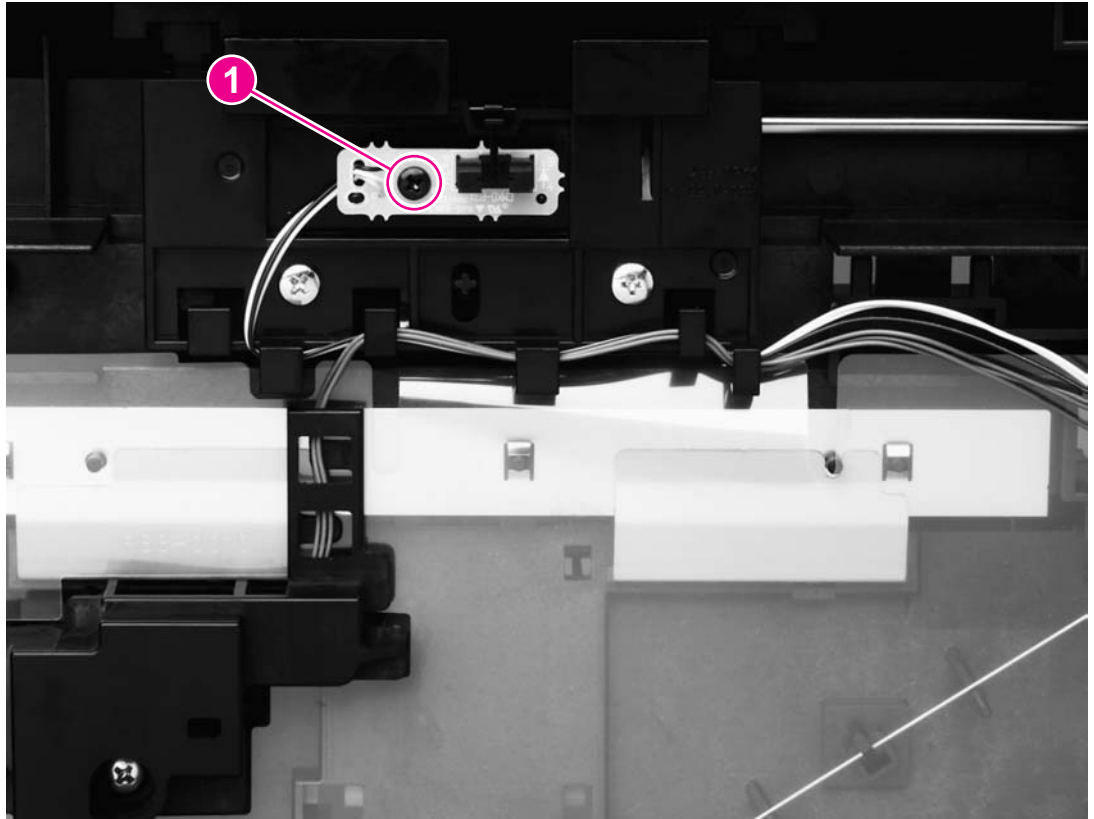

Figure 5-61. Removing the paper-top sensor

Fuser-wrap sensor

1. Remove the ECU pan (see [ECU pan](#)).
2. Remove the fuser-wrap sensor roller (see [Figure 5-53. Removing the feed-drive shaft](#)).
3. Remove one screw (callout 1) from the fuser-wrap sensor.

4. Unwind the cable from the cable harness, and unplug the cable from the dc controller.

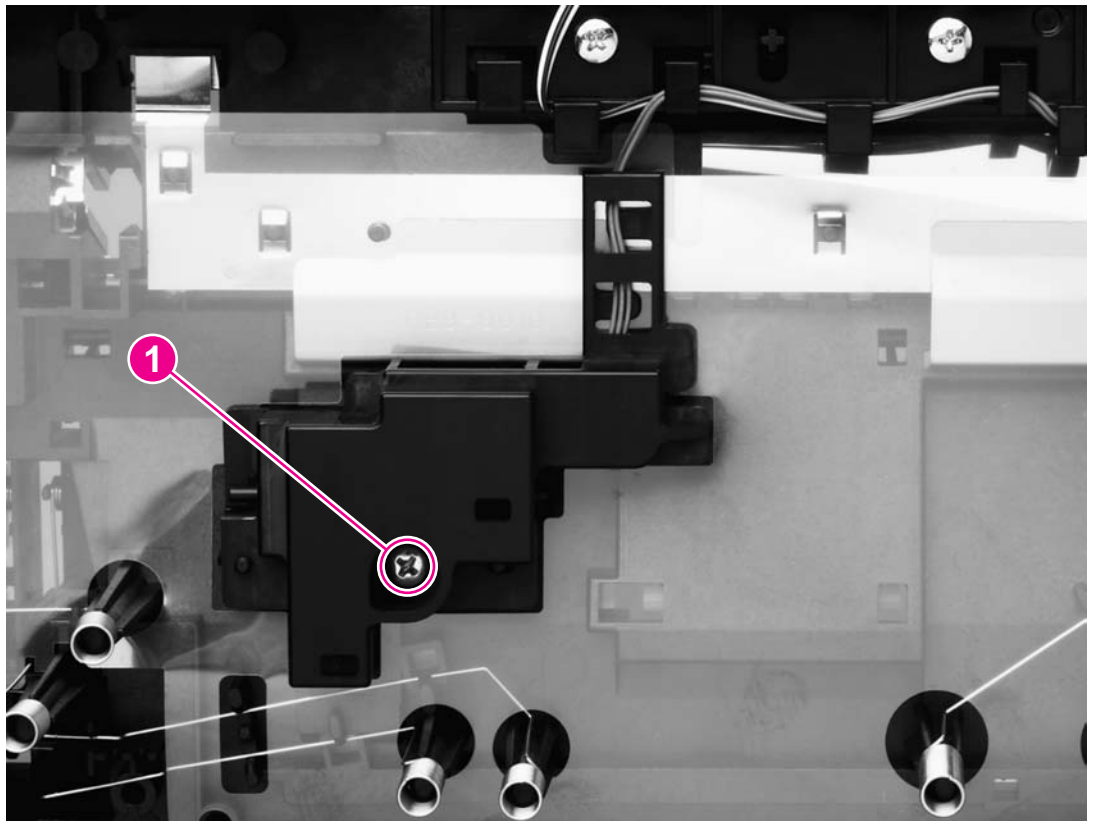

Figure 5-62. Removing the fuser wrap sensor

250-sheet feeder pickup roller

1. Remove all paper from the 250-sheet feeder and then remove the 250-sheet feeder from the printer.
2. Press the lift plate down and then pull the tray out of the feeder.
3. Turn the feeder upside-down.
4. Use a flatblade screwdriver to disengage the white, plastic lever, and then rotate the lever toward the front of the feeder to release the roller.

5. Lift the pickup roller up to remove it.

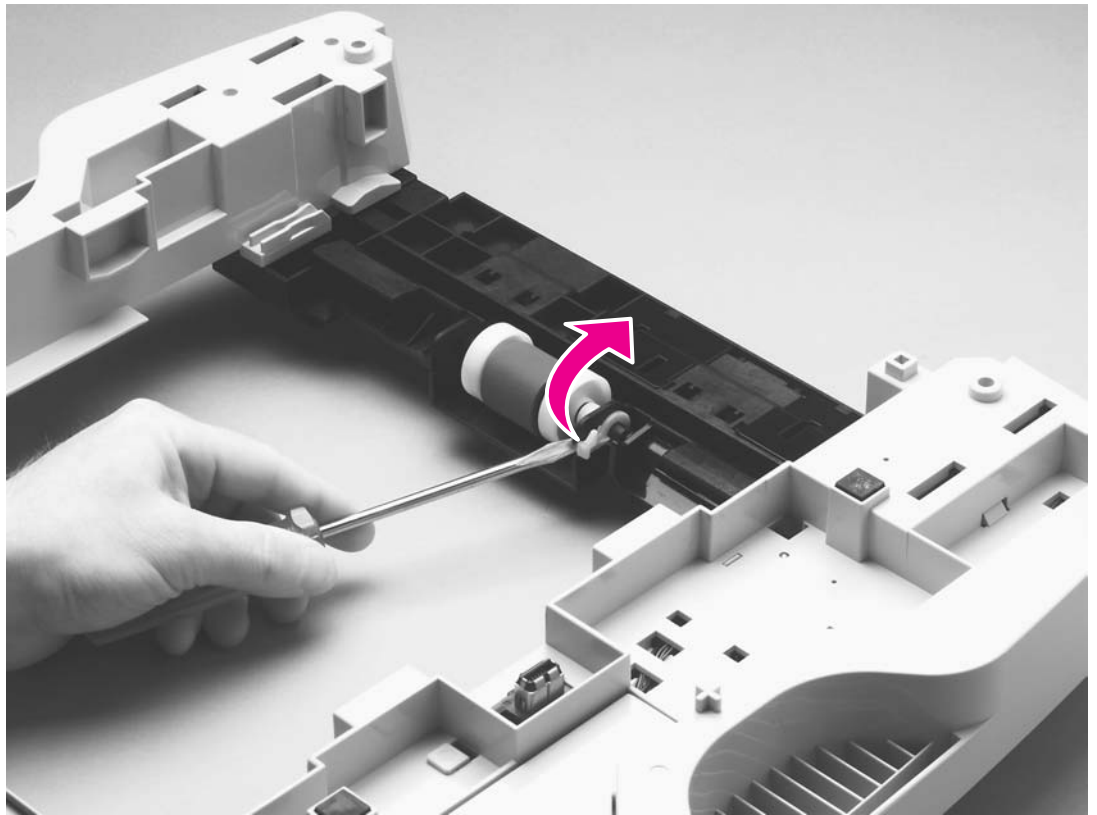

Figure 5-63.

Removing the 250-sheet feeder pickup roller

500-sheet feeder pickup roller

1. Lift the printer off of the 500-sheet feeder.
2. Remove all paper from the 500-sheet feeder.
3. Press the lift plate down and then pull the tray out of the feeder.
4. Turn the feeder so that it rests on its back side.
5. Insert the flatblade screwdriver into the slot (callout 1) on the right roller-shaft cover and then pry the cover off of the feeder.

6. Insert the flatblade screwdriver into the slot (callout 2) on the left roller-shaft cover and then pry the cover off of the feeder.

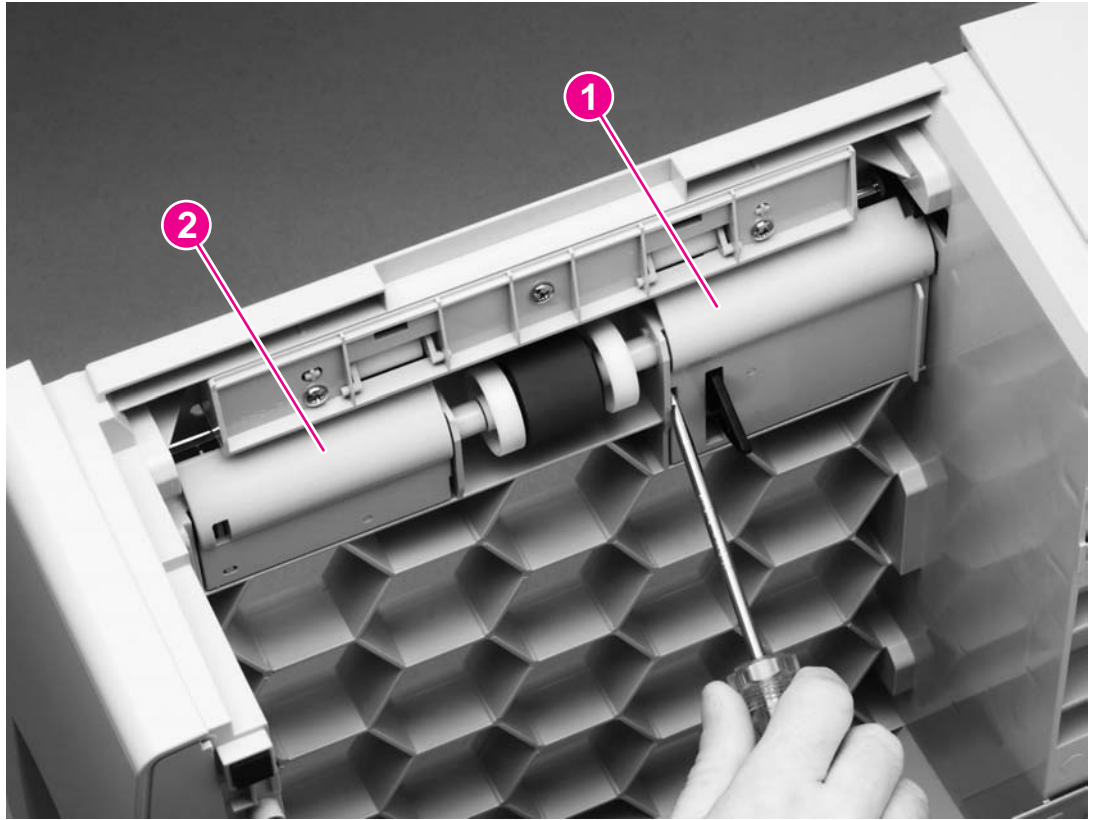

Figure 5-64. Removing the 500-sheet feeder pickup roller (1 of 2)

7. Use the flatblade screwdriver to disengage the white, plastic lever (callout 3), and then rotate the tab toward the front of the tray to release the roller.

- Lift up the pickup roller to remove it.

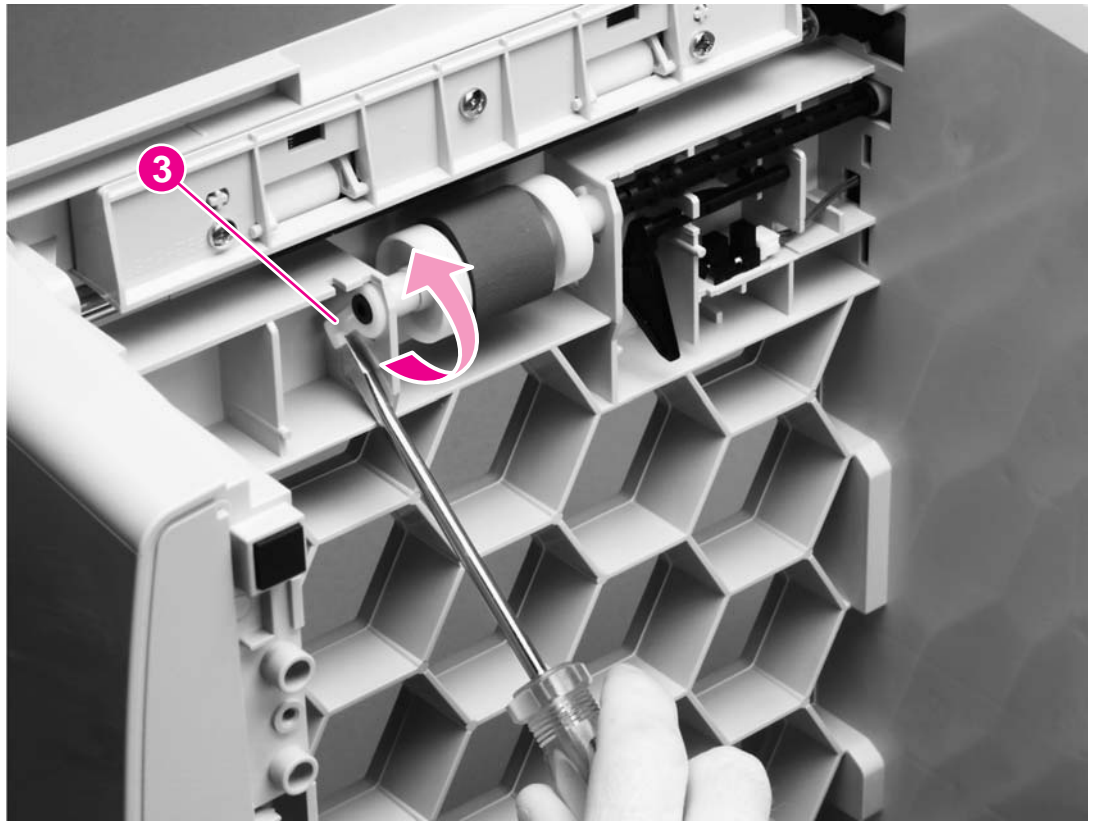

Figure 5-65. Removing the 500-sheet feeder pickup roller (2 of 2)

6

Troubleshooting

Chapter contents

Chapter contents.....	167
Basic troubleshooting	169
Clearing jams	171
Where to look for jams	171
To clear jams from inside the printer	171
To clear jams from input areas	172
To clear jams from output areas	174
Control panel light messages	176
Supplies Status lights	177
Printer Status lights	182
Solving image-quality problems	190
Print-quality checklist	190
Solving image-quality problems (all print jobs)	190
Solving image-quality problems (color print jobs)	200
Resolving problems that generated messages	204
Messages for both Windows and Macintosh	204
Messages for Windows only	204
Resolving problems that did not generate messages	206
Troubleshooting checklist	206
Checking the network	207
Solving general printing problems	207
Solving PostScript (PS) errors	212
Solving common Macintosh problems	213
Manually rotating the print-cartridge carousel	216
Functional checks	218
Engine test	218
High-voltage power-supply check	219
Paper-path check	219
Service mode functions	221
Cold reset	221
NVRAM initializer	221
Error report.....	222
Super NVRAM initialization.....	222
Network card cold reset.....	222
Using PJI commands	223
Troubleshooting tools	225
Demo page	225
Configuration page	225
Supplies Status page	226
Repetitive image defects	227

General timing charts	228
Locations of connectors	230
Dc controller connections	233
Main wiring diagram	234
HP LaserJet Toolbox	236
To view the HP LaserJet Toolbox	236

Basic troubleshooting

Table 6-1. Basic troubleshooting

Does the printer turn on successfully?

When the printer is connected to a grounded power source, the control panel lights should cycle one after another and the cartridge carousel should rotate.

Cause	Solution
No power.	<ol style="list-style-type: none"> 1. Verify that the printer is plugged directly into a wall outlet, and not plugged into a power strip or a UPS. 2. Verify that the power cable is functional and that the power on-off switch is on.
Control panel lights do not cycle.	Verify that the control panel cable is seated into both the control panel and the formatter. If the cable is connected correctly, replace the control panel.

Is the printer ready?

The printer should function without error-indicator light messages appearing on the control panel or error messages appearing on the Printer Status and Alerts screen.

Cause	Solution
Control panel lights, other than the Ready light, are on or blinking.	Consult the lists of control panel light messages (see Control panel light messages) to identify and correct the error.
An error message appears in the Printer Status and Alerts screen.	See Resolving problems that generated messages .
There is a problem, but no control panel lights are on or blinking, and no messages appear on the Printer Status and Alerts screen.	See Resolving problems that did not generate messages .

Do engine tests and information pages print?

Print an engine test (see [Functional checks](#)). The engine test should print without paper-feed problems or print-quality problems. Also print a Demo page or a configuration page (see [Troubleshooting tools](#)).

Cause	Solution
The engine test is not successful.	<p>Make sure that the formatter is connected to a power source.</p> <hr/> <p>Note</p> <p>The formatter must be connected to a power source to perform an engine test.</p> <hr/>

Table 6-1. Basic troubleshooting (continued)

Do engine tests and information pages print?

Print an engine test (see [Functional checks](#)). The engine test should print without paper-feed problems or print-quality problems. Also print a Demo page or a configuration page (see [Troubleshooting tools](#)).

Cause	Solution
The engine test is not successful.	Turn off the printer, turn on the printer, and perform another engine test.
<ul style="list-style-type: none">The engine test produces a blank page.	Make sure that the carousel is seated correctly. Replace the low-voltage power supply.
<ul style="list-style-type: none">The engine test does not produce any pages.	Replace the dc controller.
An error-indicator light message appears on the control panel.	Consult the lists of control panel light messages to identify and correct the error. See Control panel light messages .
Printer Status and Alerts software generates an error message.	See Resolving problems that generated messages .
Poor print quality.	See Hewlett-Packard limited warranty statement .

Is the software installed correctly?

Cause	Solution
Software is not installed or an error occurred during software installation.	Uninstall and then reinstall the printer software. Make sure that you use the correct installation procedure and the correct port setting.

Does the printer print from the computer?

Connect the parallel cable or USB cable to the printer and to the computer. Use a word-processing application to send a print job to the printer.

Cause	Solution
The cable is not connected correctly.	Reconnect the cable.
The cable is not within specifications.	Make sure that the the parallel cable is IEEE-1284B-compliant or that the USB cable is USB 2.0 full speed. Also make sure that the length of cables is less than 3 meters (118 inches).
An incorrect printer driver is selected.	Reset the printer driver. (Check for the correct port setting.)
Other devices are connected to the parallel port.	Disconnect the other devices and try to print again. Also, try connecting directly to the computer or through a powered USB hub.

Clearing jams

Occasionally, paper or other print media can become jammed during a print job. Causes include the following:

- Input trays are loaded improperly or are overfilled.
- Media guides in the input trays are not set correctly.
- Optional tray 2 or optional tray 3 is removed during a print job.
- The top cover is opened during a print job.
- The tabs on the fuser are unlocked or the fuser is not seated correctly.
- Too many sheets have accumulated in an output area or blocked an output area.
- The media being used does not meet HP specifications. See the *HP Color LaserJet 2550 Series Printer User Guide* for information about print-media specifications.
- The environment in which the paper was stored is too humid or too dry. See the *HP Color LaserJet 2550 Series Printer User Guide* for information about print-media specifications.
- Non-HP supplies are installed in the printer.

Where to look for jams

Jams can occur in these locations:

- Inside the printer. See [To clear jams from inside the printer](#).
- In input areas. See [To clear jams from input areas](#).
- In output areas. See [To clear jams from output areas](#).

Find and remove the jam by using the instructions on the following pages. If the location of the jam is not obvious, look first inside the printer.

Loose toner might remain in the printer after a jam. This problem should resolve itself after a few sheets have been printed. See [Loose toner](#).

To clear jams from inside the printer

CAUTION

Jams in this area might result in loose toner on the page. If you get toner on your clothes or hands, wash them in cold water. (Hot water sets toner into fabric.)

1. Open the top cover.

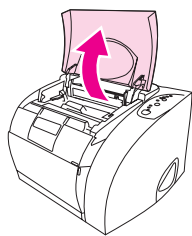

2. Remove the *imaging drum* by pushing it away from you and lifting it out of the printer.

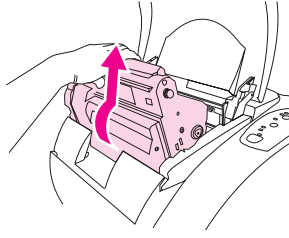

Note

You *cannot* reach jams by removing the print cartridges.

3. Complete one of these steps:
 - If the leading edge or the trailing edge of the print media is visible, *carefully* pull the sheet out of the printer.
 - If the media is too difficult to remove, clear the jam as described in [To clear jams from output areas](#).

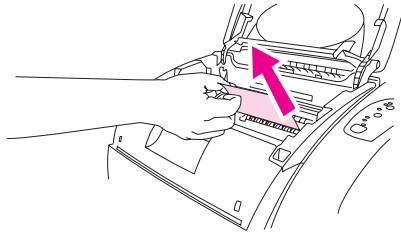

4. After the jam has been removed, replace the imaging drum and close the top cover.

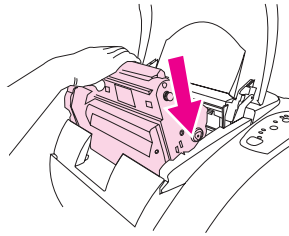

5. Press  (**Go**) if the Go light is blinking. If the Attention light is still blinking, then another jam is present. See [To clear jams from input areas](#) and [To clear jams from output areas](#).

To clear jams from input areas

1. Open optional tray 2 or optional tray 3 to expose the jam.

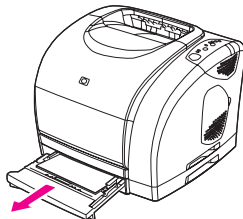

2. Complete one of these steps:

- If the media has already partially entered the printer, see [To clear jams from inside the printer](#).
- If the jam is only in the input tray, remove the jammed media by pulling it out by the visible edge. Realign all of the media in the tray and proceed to step 4.

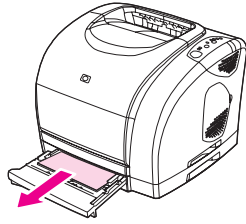

3. If you could not remove the jammed media from inside the printer or by pulling it out of the tray, grasp the sheet from the outside of the printer and carefully pull it free.

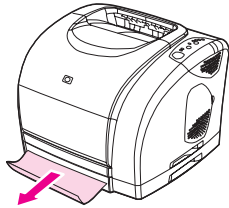

4. Push the paper down to lock the metal lift plate into place and slide the tray back into the printer.

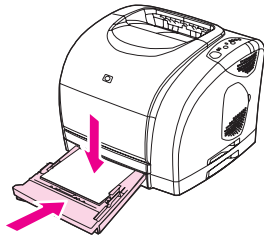

5. Open the top cover, close it again, and then press  (Go) if the Go light is blinking. If the Attention light is still blinking, then another jam is present. See [To clear jams from inside the printer](#) and [To clear jams from output areas](#).

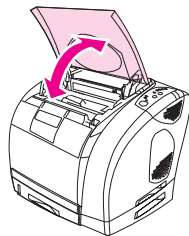

To clear jams from output areas

CAUTION

Jams in these areas might result in loose toner on the page. If you get toner on your clothes or hands, wash them in cold water. (Hot water sets toner into fabric.)

1. Complete one of these steps:

- If the media is not almost completely visible from the top output bin, proceed to step 2.
- If the media is almost completely visible, pull it carefully out of the printer and proceed to step 9.

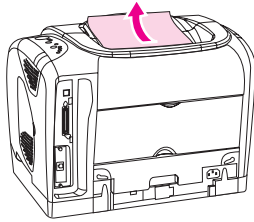

2. Open the rear output door.

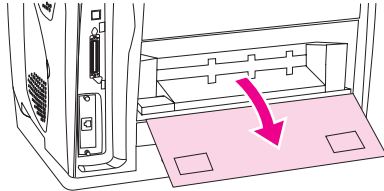

3. If the leading edge of the media is visible from the rear opening, carefully pull it out.

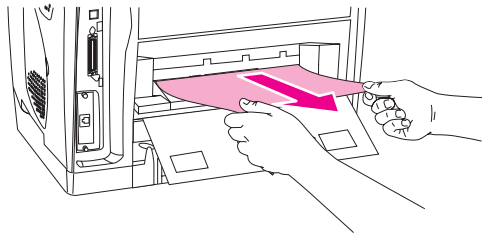

4. If the jam is too far into the printer to remove, turn off the printer and disconnect the power cable.

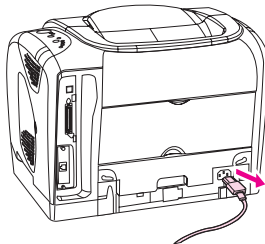

CAUTION

Always turn off the printer and disconnect the power cable before you remove the fuser.

5. Rotate the locks on the fuser to the unlocked position.

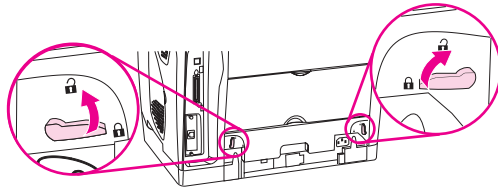

6. Grasp the fuser handles and pull to remove the fuser from the printer.

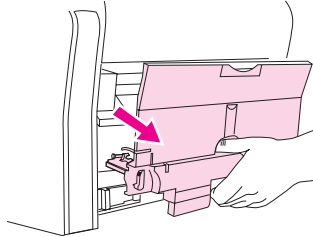

WARNING!

The parts on the internal surface of the fuser are very hot. To avoid burning yourself, do not touch those parts.

7. Press the green fuser-release levers to separate the fuser rollers, and then carefully remove any media from inside the fuser.

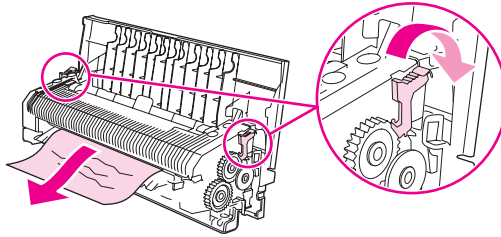

8. Using both hands, slowly and steadily remove any media from inside the printer. Then, carefully reinsert the fuser and secure the locks.

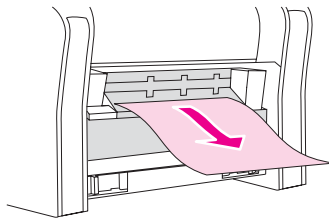

9. Reconnect the power cable and turn on the printer.
10. Open the top cover, close it again, and then press  (Go) if the Go light is flashing. If the Attention light is still blinking, then there is another jam. See [To clear jams from inside the printer](#) and [To clear jams from input areas](#).

Control panel light messages

Note

For non-error status messages, see [Supplies Status lights](#) and [Printer Status lights](#).



Each error message is listed in the following tables along with possible causes and steps to resolve the identified errors. See [Figure 6-1. Control panel lights](#) and [Table 6-2. Control panel lights legend](#) for descriptions of the control panel elements and a legend for understanding the tables.

Use the HP LaserJet Toolbox to view animations of the light patterns and to see their messages.



Figure 6-1. Control panel lights

Table 6-2. Control panel lights legend

Light symbol	Meaning of symbol
	Light off
	Light on
	Light blinking

Supplies Status lights

This section describes the meaning of the patterns for the lights in the Supplies Status area. Information about supplies also appears in the HP LaserJet Toolbox. For more information about how to use and view the HP LaserJet Toolbox, see [HP LaserJet Toolbox](#).

Table 6-3. Supplies Status light messages





Control panel message	Event log error message	Description	Recommended action
 <p>The black-print-cartridge light is on.</p>		The black print cartridge is low.	<ol style="list-style-type: none"> 1. The printer continues to print without any action required until the print cartridge is empty. 2. Order a new print cartridge.
 <p>The cyan-print-cartridge light is on.</p>		The cyan print cartridge is low.	<ol style="list-style-type: none"> 1. The printer continues to print without any action required until the print cartridge is empty. 2. Order a new print cartridge.
 <p>The magenta-print-cartridge light is on.</p>		The magenta print cartridge is low.	<ol style="list-style-type: none"> 1. The printer continues to print without any action required until the print cartridge is empty. 2. Order a new print cartridge.
 <p>The yellow-print-cartridge light is on.</p>		The yellow print cartridge is low.	<ol style="list-style-type: none"> 1. The printer continues to print without any action required until the print cartridge is empty. 2. Order a new print cartridge.

Table 6-3. Supplies Status light messages (continued)

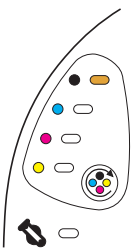

Control panel message	Event log error message	Description	Recommended action
 <p>The imaging-drum light is on.</p>		<p>The imaging drum is low.</p>	<ol style="list-style-type: none"> 1. The printer continues to print without any action required until the imaging drum fails. 2. Order a new imaging drum.
 <p>The black-print-cartridge light is blinking, and the printer stops printing.</p>	<p>10000 40208</p>	<p>The print cartridge is empty or missing (40208) or the E-label reader is faulty (10000).</p> <p>The printer cannot detect the print cartridge correctly.</p>	<ol style="list-style-type: none"> 1. Reinsert or replace the print cartridge. 2. If the print-cartridge light is still blinking but the Attention light is not on, turn the printer off and then back on. 3. If the problem persists, repeat steps 1 and 2 with black print cartridges until the error is resolved. 4. If the problem persists, replace the print-cartridge E-label reader, which is located on the pressure assembly of the print-cartridge carousel.
 <p>The cyan-print-cartridge light is blinking, and the printer stops printing.</p>	<p>10001 40207</p>	<p>The print cartridge is empty or missing (40207) or the E-label reader is faulty (10001).</p> <p>The printer cannot detect the print cartridge correctly.</p>	<ol style="list-style-type: none"> 1. Reinsert or replace the print cartridge. 2. If the print-cartridge light is still blinking but the Attention light is not on, turn the printer off and then back on. 3. If the problem persists, repeat steps 1 and 2 with cyan print cartridges until the error is resolved. 4. If the problem persists, replace the print-cartridge E-label reader, which is located on the pressure assembly of the print-cartridge carousel.

Table 6-3. Supplies Status light messages (continued)

Control panel message	Event log error message	Description	Recommended action
 <p>The magenta-print-cartridge light is blinking, and the printer stops printing.</p>	<p>10002 40206</p>	<p>The print cartridge is empty or missing (40206) or the E-label reader is faulty (10002).</p> <p>The printer cannot detect the print cartridge correctly.</p>	<ol style="list-style-type: none"> 1. Reinsert or replace the print cartridge. 2. If the print-cartridge light is still blinking but the Attention light is not on, turn the printer off and then back on. 3. If the problem persists, repeat steps 1 and 2 with magenta print cartridges until the error is resolved. 4. If the problem persists, replace the print-cartridge E-label reader, which is located on the pressure assembly of the print-cartridge carousel.
 <p>The yellow-print-cartridge light is blinking, and the printer stops printing.</p>	<p>10003 40205</p>	<p>The print cartridge is empty or missing (40205) or the E-label reader is faulty (10003).</p> <p>The printer cannot detect the print cartridge correctly.</p>	<ol style="list-style-type: none"> 1. Reinsert or replace the print cartridge. 2. If the print-cartridge light is still blinking but the Attention light is not on, turn the printer off and then back on. 3. If the problem persists, repeat steps 1 and 2 with yellow print cartridges until the error is resolved. 4. If the problem persists, replace the print-cartridge E-label reader, which is located on the pressure assembly of the print-cartridge carousel.
 <p>The four print-cartridge lights are blinking, and the printer stops printing.</p>		<p>The print cartridges are empty or missing.</p> <p>The printer cannot detect the print cartridges correctly. The E-label reader might be faulty.</p>	<ol style="list-style-type: none"> 1. Replace any non-HP print cartridges with HP print cartridges. 2. Reinsert or replace the print cartridges. 3. If the print-cartridge lights are still blinking but the Attention light is not on, turn the printer off and then back on. 4. If the problem persists, repeat steps 1 through 3 with sets of print cartridges until the error is resolved. 5. If the problem persists, replace the print-cartridge E-label reader, which is located on the pressure assembly of the print-cartridge carousel.

Table 6-3. Supplies Status light messages (continued)

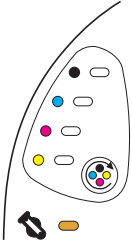

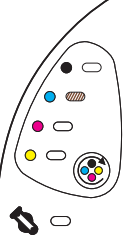



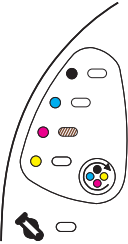
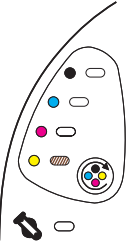
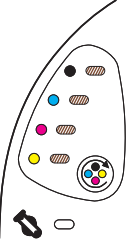

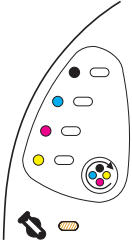
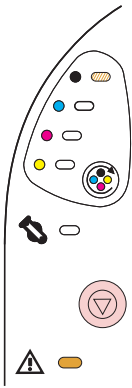

Control panel message	Event log error message	Description	Recommended action
 <p>The imaging-drum light is blinking, and the printer stops printing.</p>	10004	<p>The imaging drum is empty or missing or the E-label reader is faulty.</p> <p>The printer cannot detect the imaging drum correctly.</p>	<ol style="list-style-type: none"> 1. Reinsert or replace the imaging drum. 2. If the imaging-drum light is still blinking but the Attention light is not on, turn the printer off and then back on. 3. If the problem persists, repeat steps 1 and 2 with imaging drums until the error is resolved. 4. If the problem persists, replace the imaging-drum E-label reader (see E-label reader (for imaging-drum E-labels)).
 <p>The black-print-cartridge light is blinking and the Attention light is on. The printer stops printing.</p>	10300 10310 10320	<p>The black print cartridge is either non-HP (00), cloned (10), or unauthorized (20).</p> <p>Note</p> <p>Although HP supports customer choice, HP cannot guarantee the quality or reliability of non-HP supplies. Service or repairs required as a result of using a non-HP supply are not covered under the printer warranty.</p>	<p>If you want to use this non-HP print cartridge, press  (Cancel Job) to continue printing.</p> <p>To ensure full availability and/or accuracy of printing features (such as remaining supply status), use genuine HP supplies. If you believe you purchased a genuine HP supply, go to www.hp.com/go/anticounterfeit.</p>
 <p>The cyan-print-cartridge light is blinking and the Attention light is on. The printer stops printing.</p>	10301 10311 10321	<p>The cyan print cartridge is either non-HP (01), cloned (11), or unauthorized (21).</p> <p>Note</p> <p>Although HP supports customer choice, HP cannot guarantee the quality or reliability of non-HP supplies. Service or repairs required as a result of using a non-HP supply are not covered under the printer warranty.</p>	<p>If you want to use this non-HP print cartridge, press  (Cancel Job) to continue printing.</p> <p>To ensure full availability and/or accuracy of printing features (such as remaining supply status), use genuine HP supplies. If you believe you purchased a genuine HP supply, go to www.hp.com/go/anticounterfeit.</p>

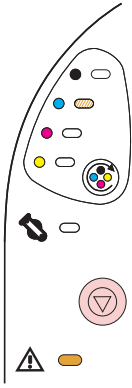
Table 6-3. Supplies Status light messages (continued)

Control panel message	Event log error message	Description	Recommended action
 <p>The magenta-print-cartridge light is blinking and the Attention light is on. The printer stops printing.</p>	<p>10302 10312 10322</p>	<p>The magenta print cartridge is either non-HP (02), cloned (12), or unauthorized (22).</p> <p>Note</p> <p>Although HP supports customer choice, HP cannot guarantee the quality or reliability of non-HP supplies. Service or repairs required as a result of using a non-HP supply are not covered under the printer warranty.</p>	<p>If you want to use this non-HP print cartridge, press  (Cancel Job) to continue printing.</p> <p>To ensure full availability and/or accuracy of printing features (such as remaining supply status), use genuine HP supplies. If you believe you purchased a genuine HP supply, go to www.hp.com/go/anticounterfeit.</p>
 <p>The yellow-print-cartridge light is blinking and the Attention light is on. The printer stops printing.</p>	<p>10303 10313 10323</p>	<p>The yellow print cartridge is either non-HP (03), cloned (13), or unauthorized (23).</p> <p>Note</p> <p>Although HP supports customer choice, HP cannot guarantee the quality or reliability of non-HP supplies. Service or repairs required as a result of using a non-HP supply are not covered under the printer warranty.</p>	<p>If you want to use this non-HP print cartridge, press  (Cancel Job) to continue printing.</p> <p>To ensure full availability and/or accuracy of printing features (such as remaining supply status), use genuine HP supplies. If you believe you purchased a genuine HP supply, go to www.hp.com/go/anticounterfeit.</p>
 <p>The imaging-drum light is blinking and the Attention light is on. The printer stops printing.</p>	<p>10304 10314</p>	<p>The imaging drum is either non-HP (04) or cloned (14).</p> <p>Note</p> <p>Although HP supports customer choice, HP cannot guarantee the quality or reliability of non-HP supplies. Service or repairs required as a result of using a non-HP supply are not covered under the printer warranty.</p>	<p>If you want to use this non-HP imaging drum, press  (Cancel Job) to continue printing.</p> <p>To ensure full availability and/or accuracy of printing features (such as remaining supply status), use genuine HP supplies. If you believe you purchased a genuine HP supply, go to www.hp.com/go/anticounterfeit.</p>

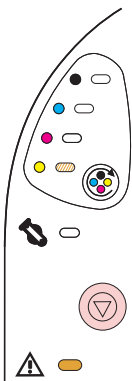
Printer Status lights

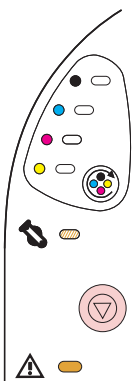
The following section describes the meaning of the light patterns in the Printer Status area.

- Printer status (see [Table 6-4. Printer-status light messages](#))
- Attention with the ability to continue errors (see [Table 6-5. Attention light messages, unnumbered](#))
- Accessory errors (see [Table 6-7. Accessory error light messages](#))
- Service errors (see [Table 6-8. Service error light messages](#))

Table 6-4. Printer-status light messages







Control panel message	Event log error message	Description	Recommended action
All control panel lights cycle.		The printer is in startup state.	Pressing buttons has no effect until the printer is in the Ready state.
 <p>The Ready (green) light is on and the printer is ready to print.</p>		The printer is in Ready state.	<ul style="list-style-type: none"> • No action is needed. • Pressing  (Go) prints a Demo page. • Pressing  (Go) and  (Cancel Job) simultaneously prints a Configuration page and a Supplies Status page, and also prints an HP Jetdirect page, if the printer is network-enabled.
 <p>The Ready (green) light is blinking.</p>		The printer is receiving or processing data.	Pressing  (Cancel Job) cancels the current job. One or two pages might print as the printer clears the print job. The printer returns to the Ready state after the job has been cancelled.

Table 6-4. Printer-status light messages (continued)

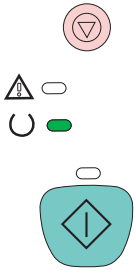

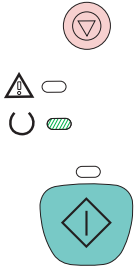

Control panel message	Event log error message	Description	Recommended action
 <p>The Attention (amber) light is blinking.</p>	40022	Attention error. The top cover is open.	Close the top cover.
	40119	Attention error. The printer is out of media.	Load media.
	50014	Attention error. The printer has a jam (40022).	Clear the jam (see Clearing jams). If the location of the jam is not apparent, check the HP LaserJet Toolbox to find the jam location. <ul style="list-style-type: none"> • If the jam is under the imaging drum, toggle the registration sensor to check its movement and replace the registration sensor if it does not move freely. • If the jam is in the fuser area, toggle the fuser exit sensor to check its movement and replace the fuser exit sensor if it does not move freely.
		Attention error. The printer has misfed media (40119).	1. Make sure that the media is loaded correctly in the input tray. 2. Open and then close the top cover.
 <p>The Go (green) light is blinking.</p>		The top cover has been opened and then closed. -Or- You pressed  (Rotate Carousel).	<ul style="list-style-type: none"> • Pressing  (Go) returns the printer to the Ready state. If you do not press  (Go), the printer automatically returns to the Ready state after approximately 10 seconds. • Pressing  (Rotate Carousel) brings another print cartridge to the top position.
		The fuser is missing or is not installed correctly (50014).	Replace the fuser.

Table 6-5. Attention light messages, unnumbered



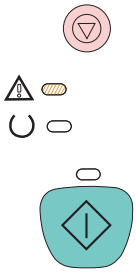
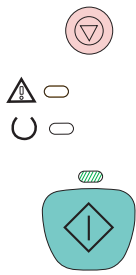





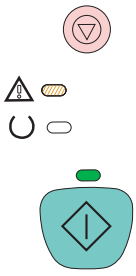

Control panel message	Event log error message	Description	Recommended action
 <p>The Attention light is blinking and the Go light is on. The printer stops printing.</p>	41103	<p>A manual-feed job was sent to the printer, and the printer is waiting for the special media (41103).</p>	<ol style="list-style-type: none"> 1. Load media into tray 1. 2. If the printer does not begin printing after the media has been reloaded, press  (Go). Or, press  (Go) to try to print from another tray if another tray is installed. <p>Note</p> <p>Single-page print jobs are not printed when  (Go) is pressed. After loading media into tray 1, reprint the page.</p> <p>After loading media into tray 1 and pressing  (Go), multiple-page print jobs continue to print, but the page that was to be printed when the printer stopped printing does not print. Reprint the page after the current print job is complete.</p>
		<p>The printer has finished printing the first side of a manual-duplex job, and the printer is waiting for the pages to be reloaded so it can print the second side.</p>	<ol style="list-style-type: none"> 1. Reload the pages. 2. If the printer does not begin printing after the pages have been reloaded, press  (Go).
		<p>Someone is trying to print by Source (tray) and there is no media in the selected tray.</p>	<ol style="list-style-type: none"> 1. Add media to the selected tray to print from it. 2. Press  (Go) to try to print from another tray.
		<p>The print image is larger than the size of media in the tray.</p>	<p>Load the correct-size media and then press  (Go).</p>
		<p>The printer has an Attention with Ability to Continue error.</p>	<ol style="list-style-type: none"> 1. Press  (Go) for the printer to attempt to recover from the error and print whatever data it can. If successful, the printer completes the job while the Ready light blinks. 2. If unsuccessful, the Attention with Ability to Continue message continues to appear. Press  (Cancel Job) to cancel the print job. If the problem has been resolved, the printer returns to the Ready state (Ready light on).

Table 6-6. Attention light messages, numbered





Control panel message	Event log error message	Description	Recommended action
 <p>The Attention light is blinking and the Go light is on. The printer stops printing.</p>	30016 30033 35031 50012	30016, memory out	<ol style="list-style-type: none"> 1. Make sure that the formatter cable is connected. 2. Press  (Go) to resume printing. If you lose some data, try to free some printer memory by removing fonts, macros, or any data currently in printer memory. If you continue to lose data, you might have to add more printer memory. For a temporary solution, simplify the image.
		30033, unexpected size	<ol style="list-style-type: none"> 1. Load the correct size of media and then press  (Go). 2. If printing does not resume, open the top cover, remove the imaging drum, and check for a jam inside the printer. 3. Turn the printer off and then back on.
		35031, invalid personality	<p>The print job was canceled, either because the printer language (personality) is not supported or because the carousel is not positioned correctly.</p> <ol style="list-style-type: none"> 1. Make sure that the carousel is positioned correctly. 2. Press  (Go) to clear the message. 3. If you printed the job using one of the PCL drivers, try printing using the PS driver, or vice versa. 4. Turn the printer off and remove or replace the language font DIMM. <hr/> <p>CAUTION</p> <p>Inserting or removing DIMMs while power is supplied to the printer can damage the DIMMs.</p>
		50012, beam detect malfunction	<ol style="list-style-type: none"> 1. Turn the printer off and then back on. 2. If the problem persists, replace the laser/scanner (see Laser/scanner assembly).

Table 6-7. Accessory error light messages

Control panel message	Event log error message	Description	Recommended action
 <p>The Attention light, Ready light, and Go light are blinking. The printer stops printing, and pressing any button has no effect.</p>		<p>Accessory error. An error has occurred in the DIMM slot.</p>	<ol style="list-style-type: none"> 1. Turn the printer off. <hr/> <p>CAUTION</p> <p>Inserting or removing DIMMs while power is supplied to the printer can damage the DIMMs.</p> <hr/> <ol style="list-style-type: none"> 2. Remove the DIMM and reinstall it to make sure that it is correctly installed. 3. Make sure that you are using a supported DIMM. See Accessories. 4. Move the DIMM to a different DIMM slot. If the DIMM works in a different slot, then DIMM slot 1 is malfunctioning. 5. To continue printing, remove the DIMM from DIMM slot 1.

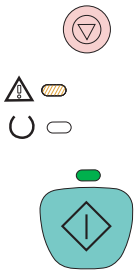
Table 6-8. Service error light messages



Control panel message	Event log error message	Description	Recommended action
 <p>The Attention light, Ready light, and Go light are on.</p>	(many)	<p>The printer has a service error.</p>	<p>Press and hold  (Go) to see a secondary error light message, and then see the secondary error light messages in this table to identify the service error. You can also use the simulator in the printer driver or the event log messages to identify the service error.</p>

Table 6-8. Service error light messages (continued)

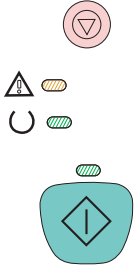
Control panel message	Event log error message	Description	Recommended action
<p>Secondary message:</p>  <p>The Ready light is on.</p>	50005	Scanner error.	<ol style="list-style-type: none"> 1. Turn the printer off and then back on. 2. Turn the printer off, and then reseal the laser/scanner cable. 3. Replace the laser/scanner (see Laser/scanner assembly).
<p>Secondary message:</p>  <p>The Attention light is blinking.</p>	50006	Fan motor error.	<ol style="list-style-type: none"> 1. Turn the printer off. 2. Check cable connections to the fan. 3. Turn the printer back on. 4. If the error persists, replace the fan (see Air duct and fan).
<p>Secondary message:</p>  <p>The Attention light is on.</p>	50007 50021	<p>Engine communication error.</p> <p>Dc controller memory error.</p> <p>The formatter is not communicating with the printer engine (50007).</p> <p>The dc controller is faulty (50021).</p>	<ol style="list-style-type: none"> 1. Turn the printer off and then back on. 2. Check the connections to the formatter and the dc controller. 3. Replace the formatter (see Formatter assemblies). 4. Replace the dc controller (see Dc controller). 5. Replace the laser/scanner (see Laser/scanner assembly).
<p>Secondary message:</p>  <p>The Ready and Go lights are on.</p>	50008 50009 50010 50015	<p>Low fuser-temperature error</p> <p>Slow fuser error</p> <p>High fuser-temperature error</p> <p>Fuser drive-circuit error</p>	<ol style="list-style-type: none"> 1. Turn the printer off for approximately 20 to 30 minutes. 2. If the printer is plugged into a power-strip or a UPS, unplug it and plug the printer power cord directly into a wall socket. 3. Turn the printer back on. 4. If the error persists, replace the fuser (see Fuser cover (and fuser)).

Table 6-8. Service error light messages (continued)

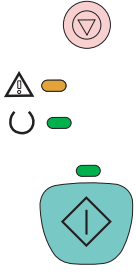
Control panel message	Event log error message	Description	Recommended action
<p>Secondary message:</p>  <p>The Ready light and Go light are blinking.</p>	<p>50019 50023 50024</p>	<p>Fuser motor error Developer motor error Main motor error</p>	<ol style="list-style-type: none"> 1. Turn the printer off and then back on. 2. If the error persists, replace the motor that causes the error.
<p>Secondary message:</p>  <p>The Ready light is blinking.</p>	<p>50020 50031</p>	<p>Bad top-of-page sensor Top-of-page sensor error</p>	<ol style="list-style-type: none"> 1. Clean the top-of-page sensor. 2. Replace the imaging drum. 3. If the error persists, replace the top-of-page sensor (see Density sensor and top-of-page sensor).
<p>Secondary message:</p>  <p>The Attention and Go lights are on.</p>	<p>50022</p>	<p>T2 clutch error.</p>	<ol style="list-style-type: none"> 1. Turn the printer off and then back on. 2. If the error persists, replace the clutch (see Gear assembly).

Table 6-8. Service error light messages (continued)

Control panel message	Event log error message	Description	Recommended action
Secondary message:  The Attention and Ready lights are on.	50025	Carousel motor error	<ol style="list-style-type: none"> 1. Turn the printer off and then back on. 2. If the error persists, replace the motor (see Rotary-drive assembly).

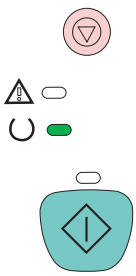
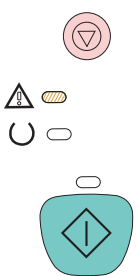
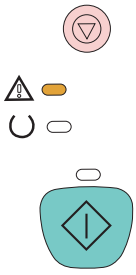
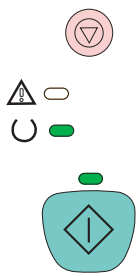
Table 6-9. Additional error messages

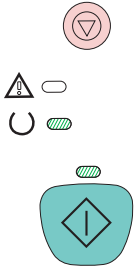
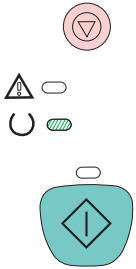
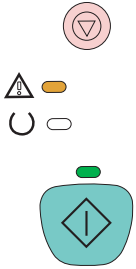

Control panel message	Event log error message	Description	Recommended action
(No light pattern.)	50026	Yellow density out-of-range	<ol style="list-style-type: none"> 1. Turn the printer off and then back on. 2. If the problem persists, replace the appropriate sensor.
	50027	Magenta density out-of-range	
	50028	Cyan density out-of-range	
	50029	Black density out-of-range	
	50030	Density sensor error	
	50031	Top-of-page sensor error	

Solving image-quality problems

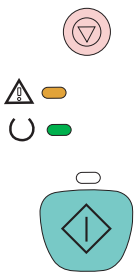
If your document is printing but the quality is not what you expected, start by using the print-quality checklist.

Print-quality checklist

Use the following checklist to solve general print-quality problems:

1. Check the printer driver to make sure that you are using the best available print-quality option, or return to the default settings. See the *HP Color LaserJet 2550 Series Printer User Guide* for more information about print-quality options.
2. Make sure that the paper or print media you are using meets specifications. See the *HP Color LaserJet 2550 Series Printer User Guide* for more information. Generally, smoother paper provides better results.
3. If you are using a special print media such as labels, transparencies, or letterhead, make sure that you selected the correct media type (see the **Paper** tab in the printer driver). See the *HP Color LaserJet 2550 Series Printer User Guide* for information about HP print-media specifications. Also see the *HP LaserJet Printer Family Print Media Guide* (<http://www.hp.com/support/ljpaperguide>).
4. Print a Configuration page and Supplies Status page at the printer by pressing  (**Go**) and  (**Cancel Job**) simultaneously. If the pages do not print, then the problem is in the hardware rather than in the software.
 - Check printer status messages on the Configuration page.
 - Check the Supplies Status page to see if any supplies are low or empty. Note that no information is provided for non-HP print cartridges. Replace non-HP print cartridges with HP print cartridges.
5. Use the HP LaserJet Toolbox to print a Demo page. If the page prints correctly, there might be a problem with the printing software. Uninstall the printing software and then reinstall it (see the *HP Color LaserJet 2550 Series Printer Getting Started Guide*).
6. Try printing from one of the other printer drivers. For example, if you are using the PCL 6 printer driver, print from the PS printer driver.
7. Try printing from a different program. If the page prints correctly, the problem might be in the program from which you were printing.
8. Restart the computer and the printer and try printing again. If the problem is not resolved, choose one of these options:
 - If the problem is affecting all printed pages, see [Solving image-quality problems \(all print jobs\)](#).
 - If the problem is affecting only pages that are printed in color, see [Solving image-quality problems \(color print jobs\)](#).

Solving image-quality problems (all print jobs)

The following examples depict letter-size paper that has passed through the printer short-edge first. These examples illustrate problems that would affect all pages you print, whether you print in color or in black only. The topics that follow list the typical cause and solution for each of these examples.

Light print or fade	Toner specks	Dropouts	Vertical lines
Gray background	Toner smear	Loose toner	Repetitive defects on the front
Repetitive defects on the back	Misformed characters	Curl or wave	Page skew
Wrinkles or creases	Toner scatter outline	Random image repetition	Random image repetition

Light print or fade

A vertical streak or an incorrect or faded color area appears on the page.

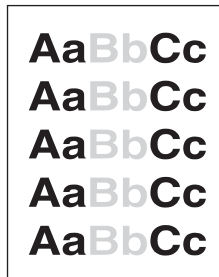

- The paper might not meet HP's paper specifications (for example, the paper is too moist or too rough). See the *HP Color LaserJet 2550 Series Printer User Guide* for information about print-media specifications.
- One or more print cartridges are low. If you are using non-HP print cartridges, no messages appear on the printer control panel or in the HP LaserJet Toolbox.
- The imaging drum might be low or empty. Print the Supplies Status page to check remaining life. Replace the imaging drum if it is low or empty.
- If none of the print cartridges or the imaging drum is low or empty, remove the print cartridges one at a time and inspect the toner roller in each to see if the roller is damaged. If so, replace the print cartridge.
- Inspect the imaging drum for toner dust, oil, or fingerprints.
- If the problem is not resolved, see [If the problem is not resolved](#).

Toner specks

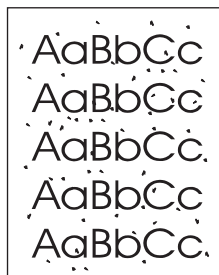

- The paper might not meet specifications. For example, the paper is too moist or too rough. See the *HP Color LaserJet 2550 Series Printer User Guide* for information about print-media specifications.
- The paper path might need to be cleaned. See [To use a cleaning page](#) for details.
- If using a cleaning page did not solve the problem, then check the fuser for contamination and replace the fuser, if necessary.
- If the problem is not resolved, see [If the problem is not resolved](#).

Dropouts

Faded areas, generally rounded, occur randomly on the page.

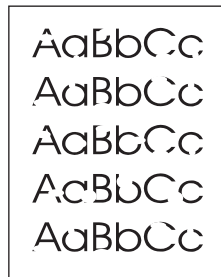

- A single sheet of paper might be defective. Try reprinting the job.
- The paper path might need to be cleaned. Open the HP LaserJet Toolbox to use the cleaning page. See [To use a cleaning page](#) for details.
- The moisture content of the paper is uneven or the paper has moist spots on its surface. Try different paper, such as high-quality paper designed for laser printers. See the *HP Color LaserJet 2550 Series Printer User Guide* for information about print-media specifications.
- The paper lot is flawed. The manufacturing processes can cause some areas to reject toner. Try a different brand of paper, such as high-quality paper designed for laser printers. See the *HP Color LaserJet 2550 Series Printer User Guide* for information about print-media specifications.
- The imaging drum might be defective. See .
- If the problem is not resolved, see [If the problem is not resolved](#).

Vertical lines

Vertical streaks or bands appear on the page.

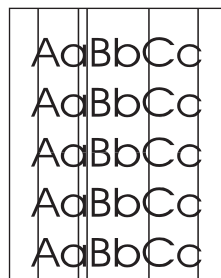

- One or more print cartridges are low or defective. Print the Supplies Status page to check remaining life. If you are using non-HP print cartridges, no messages appear on the printer control panel or in the HP LaserJet Toolbox.
- Clean the printer using a cleaning page. Open the HP LaserJet Toolbox to use the cleaning page. See [To use a cleaning page](#) for details.
- Use the tools on the **Troubleshooting** tab of the HP LaserJet Toolbox to correct the problem.
- Inspect the imaging drum for toner dust, oil, or fingerprints.
- Check the jam-access door.
- If the problem is not resolved, see [If the problem is not resolved](#).

Gray background

The amount of background toner shading is unacceptable.



- Clean the density sensor and perform a calibration. See [To use a cleaning page](#).
- Use a different paper with a lighter basis weight. See the *HP Color LaserJet 2550 Series Printer User Guide* for information about print-media specifications.
- Check the printer environment. Very dry (low humidity) conditions can increase the amount of background shading.
- One or more print cartridges are low. If you are using non-HP print cartridges, no messages appear on the printer control panel or in the HP LaserJet Toolbox.
- The imaging drum might be low or empty. Print the Supplies Status page to check remaining life. Replace the imaging drum if it is low or empty.
- If the problem is not resolved, see [If the problem is not resolved](#).

Toner smear

Toner smear appears on the leading edge.



- Check the paper type and quality. Use a different paper, such as high-quality paper designed for laser printers. See the *HP Color LaserJet 2550 Series Printer User Guide* for information about print-media specifications.
- The paper guides is dirty, or debris is in the print path. Open the HP LaserJet Toolbox to use the cleaning page. See [To use a cleaning page](#) for details.
- The imaging drum might be low or empty. Check the status of the imaging drum at the printer control panel or in the HP LaserJet Toolbox and replace the imaging drum if it is low or empty.
- The fuser might not be heating correctly. If the printer is plugged into a surge protector, plug it directly into the wall.
- If the problem is not resolved, see [If the problem is not resolved](#).

Loose toner

Toner smears easily when touched.

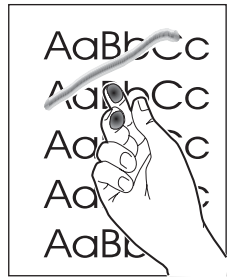

- In the printer driver, select the **Paper** tab and set **Type is** to match the type of paper on which you are printing. Print speed might be slower if you are using heavy paper.
- Check the paper type and quality. Use a different paper, such as high-quality paper designed for laser printers. See the *HP Color LaserJet 2550 Series Printer User Guide* for information about print-media specifications.
- Clean the inside of the printer. Open the HP LaserJet Toolbox to use the cleaning page. See [To use a cleaning page](#) for details.
- The fuser or imaging drum might be damaged.
- If the problem is not resolved, see [If the problem is not resolved](#).

Repetitive defects on the front

Marks repeatedly appear on the printed side of the page at even intervals.

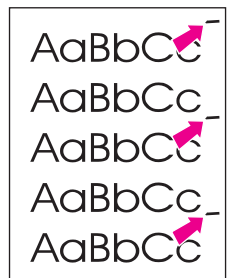

- In the printer driver, select the **Paper** tab and set **Type is** to match the type of paper on which you are printing. Print speed might be slower if you are using heavy paper.
- Clean the printer. Open the HP LaserJet Toolbox to use the cleaning page. See [To use a cleaning page](#) for details.
- Use the tools on the **Troubleshooting** tab of the HP LaserJet Toolbox to correct the problem.
- The imaging drum might be defective. Replace the imaging drum.
- The fuser or imaging drum might be damaged.
- One of the print cartridges might be defective. Examine the print cartridges and replace as needed.
- If the problem is not resolved, see [If the problem is not resolved](#).

Repetitive defects on the back

Marks repeatedly appear on the unprinted side of the page at even intervals.

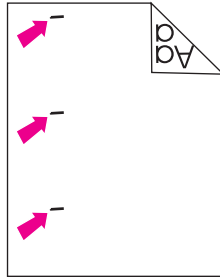

- Internal parts might have toner on them. The problem will likely correct itself after a few more pages.
- Clean the printer. Open the HP LaserJet Toolbox to use the cleaning page. See [To use a cleaning page](#) for details.
- The fuser or imaging drum might be damaged.
- If the problem is not resolved, see [If the problem is not resolved](#).

Misformed characters

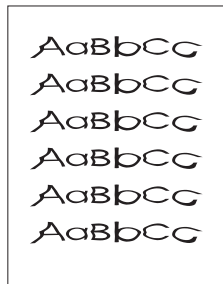

- If characters are improperly formed so that they produce hollow images, the paper might be too slick (for example, photo, glossy, or coated paper). Use a different paper, such as high-quality paper designed for laser printers. See the *HP Color LaserJet 2550 Series Printer User Guide* for information about print-media specifications.
- If characters are improperly formed so that they produce a wavy effect, the laser/scanner might need service. Verify that the problem also occurs on the Configuration page. If so, replace the laser/scanner.
- If the problem is not resolved, see [If the problem is not resolved](#).

Curl or wave

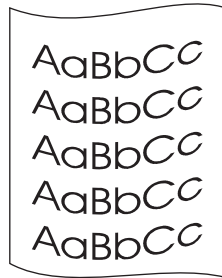

- Make sure that the printer has adequate ventilation by verifying that the fan is not blocked.
- Plug the printer directly into a wall outlet. Do not use a power-strip or a UPS.
- Turn over the stack of paper in the tray. Also try rotating the paper 180 degrees in the input tray.
- Set the correct type in the printer driver. Heavier paper might take longer to print.
- Open the rear output door to print to the straight-through paper path.
- Check the paper type and quality. Both high temperature and humidity will cause paper curl. Try a new, unopened ream of paper or try using a different paper, such as high-quality paper designed for laser printers. See the *HP Color LaserJet 2550 Series Printer User Guide* for information about print-media specifications.
- If the problem is not resolved, see [If the problem is not resolved](#).

Page skew

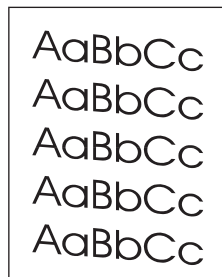

- Make sure that the paper or other print media is loaded correctly and that the guides are not too tight or too loose against the stack. See [Loading media](#).
- Check the paper type and quality. Use a different paper, such as high-quality paper designed for laser printers. See the *HP Color LaserJet 2550 Series Printer User Guide* for information about print-media specifications.
- Clean the printer (see [Cleaning the printer](#)).
- Calibrate the printer (see [Calibrating the printer](#)).
- If the problem is not resolved, see [If the problem is not resolved](#).

Wrinkles or creases

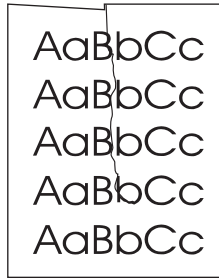

- Make sure that paper is loaded properly.
- Turn over the stack of paper in the input tray, or try rotating the paper 180 degrees in the input tray.
- Open the rear output door to print to the straight-through paper path.
- Check the paper type and quality. Use a different paper, such as high-quality paper designed for laser printers. See the *HP Color LaserJet 2550 Series Printer User Guide* for information about print-media specifications.
- Reseat the fuser.
- If the problem is not resolved, see [If the problem is not resolved](#).

Toner scatter outline

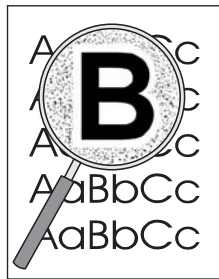

- Turn over the stack of paper in the tray.
- Clean the density sensor and perform a calibration. See [To use a cleaning page](#).
- Small amounts of toner scatter are normal for laser printing.
- If large amounts of toner have scattered around the characters, the paper might have high resistivity. Use a different paper, such as high-quality paper designed for laser printers. See the *HP Color LaserJet 2550 Series Printer User Guide* for information about print-media specifications.
- Change the print mode in the HP LaserJet Toolbox to dry-media mode.
- If the problem is not resolved, see [If the problem is not resolved](#).

Random image repetition

If an image that appears at the top of the page (in solid black) repeats farther down the page (in a gray field), the toner might not have been completely erased from the last print job. The repeated image might be lighter or darker than the field in which it appears.

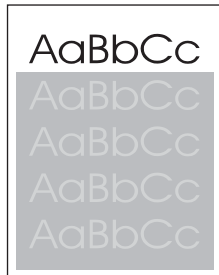

- Clean the printer. Open the HP LaserJet Toolbox to use the cleaning page. See [To use a cleaning page](#) for details.
- In your program, change the tone (darkness) of the field in which the repeated image appears.
- In your program, rotate the whole page 180 degrees to print the lighter image first.
- Change the order in which the images are printed. For example, have the lighter image at the top of the page, and the darker image farther down the page.
- If the defect occurs later in a print job, turn the printer off for 10 minutes, and then turn the printer on to restart the print job.
- Replace the imaging drum.
- Replace the fuser.
- If the problem is not resolved, see [If the problem is not resolved](#).

If the problem is not resolved

If the problem is not resolved, try these steps:

1. Perform a cleaning and calibration. See [Calibrating the printer](#).
2. Print the Configuration page and Supplies Status page again.
 - If the pages print correctly, then the problem is in the program, the computer, or the printer driver.
 - If the pages do not print correctly, then the problem is in the printer hardware. The problem might be the fuser or the imaging drum.
3. Change the **Type** setting in the printer driver, or change the print mode. If this step does not help, proceed to the next step.

4. If the problem persists, check the paper type and quality. (See the *HP Color LaserJet 2550 Series Printer User Guide* for information about print-media specifications.) Use a different paper, such as high-quality paper designed for laser printers.
5. Print to a different printer.
 - If the page prints correctly, then the problem might be in the printer driver. Uninstall the printer driver and reinstall it.
 - If the page does not print correctly, the problem is in the program or the computer. See the documentation for the program or the computer.

Solving image-quality problems (color print jobs)

This section describes issues that can occur when you print in color.

Note

Whenever you experience color-related issues, calibrate the printer before trying any other steps. See [Calibrating the printer](#).

Only black prints

Only black is printing when the document should be printing in color.

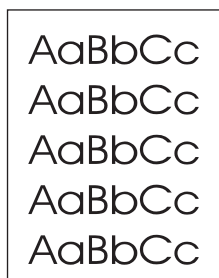

- Color mode is not selected in your program or printer driver. Select color mode instead of grayscale mode.
- The correct printer driver is not selected in the program. Select the correct printer driver.
- The printer is not properly configured. Check the printer configuration by printing a Configuration page. If no color appears on the Configuration page, replace the imaging drum.

Missing or incorrect color

One or more colors are not printing, or are inaccurate.

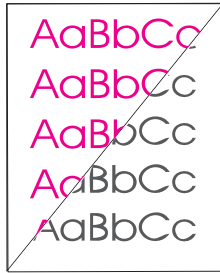

- You have changed the color settings manually. Return the color setting to Automatic.
 - Windows: On the **Color** tab of the printer driver, click **Automatic**.
 - Mac OS: In the **Print** dialog box, select the **Color Options** tab, and then select **Automatic**.
- Turn the printer off and then on again.
- Your print media does not meet the specifications for this printer. Use a different paper, such as a high-quality paper designed for laser printers. See the *HP Color LaserJet 2550 Series Printer User Guide* for information about print-media specifications.
- You are operating the printer in excessively humid or dry conditions. Verify that the printer environment is within humidity specifications.
- A print cartridge might be low on toner. Check the printer control panel, print a Supplies Status page, or view the HP LaserJet Toolbox to see supplies status. (If you are using a non-HP cartridge, none of these sources will provide information about a low or empty print cartridge.) If a cartridge is low on toner, replace the print cartridge.
- Clean the sensors and perform a calibration. See [To use a cleaning page](#).

Color prints inconsistently

A color is printing inconsistently after you load a new print cartridge.

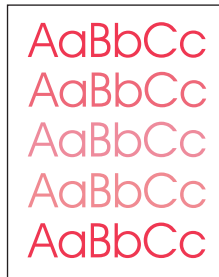

- Another print cartridge might be low on toner. Check the supplies status lights or the HP LaserJet Toolbox to see if a print cartridge is low, and replace it if necessary. If you are using a non-HP print cartridge, it might be low or empty but you will receive no indication.
- Print cartridges might be improperly installed. Remove the print cartridge for the color that is printing inconsistently and reinstall it.
- Your print media does not meet the specifications for this printer. Use a different paper, such as a high-quality paper designed for laser printers. See the *HP Color LaserJet 2550 Series Printer User Guide* for information about print-media specifications.

Colors do not match

The colors on the printed page do not match the colors as they appear on the screen.

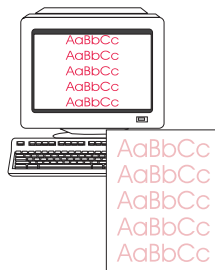

- Your print media does not meet the specifications for this printer. Use a different paper, such as a high-quality paper designed for laser printers. See the *HP Color LaserJet 2550 Series Printer User Guide* for information about print-media specifications.
- The colors on your computer monitor differ from the printer output. Try selecting **Automatic** on the **Color** tab of the printer driver.
- Print the Configuration and Supplies Status pages to make sure that they print correctly. If not, the problem is with the printer.
- Try printing from a different program or from one of the other printer drivers. For example, if you are using the PCL 6 printer driver, try the PS printer driver.
- Extremely light colors or extremely dark colors on screen are not printing. Your program might interpret extremely light colors as white or extremely dark colors as black. If so, avoid using extremely light or extremely dark colors.
- Clean the sensors and perform a calibration. See [Calibrating the printer](#).

Color pages have inconsistent finish

The finish on the printed color page is inconsistent.



- Use a smooth paper or print media, such as a high-quality paper designed for laser printers. Generally, the smoother the paper, the better the results. See the *HP Color LaserJet 2550 Series Printer User Guide* for information about print-media specifications.

Resolving problems that generated messages

This section helps resolve problems that generated messages on the computer.

Messages for both Windows and Macintosh

This section lists some common errors that only provide a simple message but no information for resolving the error. Errors that you see in the HP LaserJet Toolbox provide their own instructions for resolving the error. For other errors generated by your operating system, see the documentation for the operating system or computer.

Limit Check Error

Cause	Solution
The print job is too complex.	<ul style="list-style-type: none">• Reduce the complexity of the page. For example, try using fewer fonts.• Use one of the other printer drivers.• Send the print job in smaller pieces or with a fewer number of pages.

Messages for Windows only



Cause	Solution
"Error Writing to LPTx" in Windows 98 or Me	<ul style="list-style-type: none">• Make sure that the tray contains print media.• Make sure that the cables are connected correctly, the printer is on, and the Ready light is on.• Print a Demo page from the HP LaserJet Toolbox to make sure that the computer can communicate with the printer.• On the Start menu, point to Settings and then click Printers. Right-click the HP color LaserJet 2550 driver and select Properties. Click Details and then click Port Settings. Clear the Check Port State before Printing check box and then click OK. Click Spool Settings, select Print Directly to Printer, and then click OK.• Try again to print.

Cause	Solution
"General Protection Fault" "Exception OE" "Spool32" "Illegal Operation"	<ul style="list-style-type: none"> ● Restart the computer and try again. ● Clear the contents of the computer Temp folder, which is generally located in C:\Windows (95, 98, and Me) or C:\Winnt (NT 4.0, 2000, and XP). ● Change the graphics mode in the driver from raster to vector, or from vector to raster.
Other Windows messages	For more information, see Microsoft Windows documentation that came with the operating system or computer.

Resolving problems that did not generate messages

Troubleshooting checklist

If the printer is not responding properly, complete the steps in the following checklist, in order. If the printer does not pass a step, follow the corresponding troubleshooting suggestions. If a step resolves the problem, you can stop without performing the rest of the steps on the checklist.

1. Make sure that the printer Ready light is on. If no lights are on, complete the following steps:
 - a. Check the power cable connections.
 - b. Make sure that the power switch is on.
 - c. Check the power source by plugging the printer directly into the wall or into a different outlet.
 - d. If none of these measures restores power, replace the low-voltage power supply.
 - e. If replacing the low-voltage power supply does not restore power, replace the dc controller.
2. Check the cabling.
 - a. Check the cable connection between the printer and the computer or network port. Make sure that the connection is secure.
 - b. Make sure that the cable itself is not faulty by using a different cable, if possible.
 - c. Check the network connection. See [Checking the network](#).
3. Make sure that the print media you are using meets specifications. See the *HP Color LaserJet 2550 Series Printer User Guide* for information about print-media specifications.
4. Press  (**Go**) and  (**Cancel Job**) simultaneously to print a Configuration page and a Supplies Status page. If the printer is network-enabled, an HP Jetdirect page also prints.
 - If the Configuration and Supplies Status pages do not print, check the following items:
 - a. Check that there is paper in at least one of the printer input trays.
 - b. If the page jams in the printer, see [Clearing jams](#).
 - c. Try again to print the Configuration and Supplies Status pages.
 - If the Configuration and Supplies Status pages print, check the following items:
 - a. If the pages print correctly, then the printer hardware is working. The problem is in the computer you are using, the printer driver, or the program.
 - b. If the pages do not print correctly, calibrate the printer. See [Calibrating the printer](#).
 - c. Print the pages again. If the pages still do not print correctly, the problem is in the printer hardware.
5. At the computer, check the print queue or print spooler (Print Monitor or Print Center Queue for Mac OSs) to see if the printer is paused or set to print offline.
6. Verify that you have installed the HP color LaserJet 2550 series printer driver. Check the program to make sure that you are using the HP color LaserJet 2550 series printer driver.
7. Print a page from the HP LaserJet Toolbox, if available.

- a. If the page prints, then the problem is in the printer driver. For Windows, try using the other printer driver. Or, for Windows or Macintosh, uninstall the printer driver (see the *HP Color LaserJet 2550 Series Printer User Guide* for information about uninstalling the printing software) and reinstall it (see the *HP Color LaserJet 2550 Series Printer Getting Started Guide*).
 - b. If the page does not print, then the problem is in the computer or the program.
8. Print a short document by using a different program that has worked in the past. If this solution works, then the problem is in the program you are using. If this solution does not work (the document does not print) complete these steps:
- a. Try printing the job from another computer that has the printer software installed.
 - b. If you connected the printer to the network, connect the printer directly to a computer by using a parallel cable or USB cable. Redirect the printer to the correct port, or reinstall the software and select the new connection type you are using.
9. If the problem is still not resolved, see [Solving general printing problems](#).

Checking the network

It is recommended that you use the HP color LaserJet 2550 series printer CD-ROM to install and set up the printer on a network.

Follow these steps to see if the problem is caused by the network.

- When the Configuration page printed, an HP Jetdirect configuration page should have printed if the printer is network-enabled. (If these pages do not print in your language, see [Troubleshooting tools](#).) Verify that all network settings are correctly configured.
- Contact the network administrator for assistance.

Solving general printing problems

In addition to the problems listed in this section, see [Solving common Macintosh problems](#) if you are using a Macintosh computer, and see [Solving PostScript \(PS\) errors](#) if you are using several printer languages.

Table 6-10. Solving general printing problems

The print job is extremely slow.

Cause	Solution
The job might be very complex (for example, if it contains graphics).	<ul style="list-style-type: none"> • Wait for the job to print. • Reduce the complexity of the page or try adjusting the print-quality settings. If this problem occurs frequently, add memory to the printer.
The maximum speed is 16 ppm in black and 4 ppm in color and cannot be exceeded even when more memory is added.	Wait for the print job to finish.
Printing speeds might be automatically reduced when printing special-size media.	Wait for the print job to finish.

Table 6-10. Solving general printing problems (continued)

The print job is extremely slow.

Cause	Solution
<p>In the printer driver, the Type or Size is set incorrectly for the media in the printer.</p>	<ul style="list-style-type: none"> • If you are printing on heavy paper, the Type or Size should be set to a heavy paper setting. The printer prints more slowly to provide better quality. Wait for the job to print. • If you are not printing on heavy paper, set Type or Size in the printer driver to plain paper. • In the default settings for this printer, click the Paper tab and make sure that Type is set to plain paper. You can override this setting from the printer driver when you print on heavy paper.
<p>An issue might exist with the driver.</p>	<ul style="list-style-type: none"> • If you are printing using a PCL driver, print using the PS driver, or vice versa.

The printer pulls paper or print media from the wrong tray.

Cause	Solution
<p>The Source (tray) selection might be incorrect.</p>	<ul style="list-style-type: none"> • For Windows, make sure that the Source is selected from the Print dialog box (which is part of the program) if possible or in the printer driver. If you select the Source in the printer driver and then select a different Source in the Print dialog box, the Source setting in the printer driver changes to match the Source setting in the Print dialog box. • For Macintosh, set the Source in the Print dialog box. • Remove any media from other trays to make the printer select from the tray you want, and then press  (Go).
<p>The Type or Size setting does not match the size of paper or print media loaded in the tray.</p>	<p>Using the HP LaserJet Toolbox, change the Type or Size setting for the tray to match the size of print media that is loaded.</p>
<p>Media is loaded in tray 1.</p>	<p>Remove any media from tray 1. The printer pulls from tray 1 if you did not specify a tray that had a compatible size or type loaded and tray 1 is unconfigured.</p>

Printer does not pull paper from optional tray 2 or optional tray 3.

Cause	Solution
<p>The rear paper length guide (optional tray 2) or the rear paper stop (optional tray 3) is set incorrectly.</p>	<p>To set the rear guides properly, see Loading optional tray 2 or Loading optional tray 3.</p>

Table 6-10. Solving general printing problems (continued)**Printer does not pull paper from optional tray 2 or optional tray 3.**

Cause	Solution
The tray is not recognized in the printer software.	Configure the printer software to recognize the tray.
If the printer does not pull paper from either tray, the problem might be the paper.	<ul style="list-style-type: none"> • Try a different type or brand of paper. • Make sure that you are using a high-quality paper made for laser printers. See the <i>HP Color LaserJet 2550 Series Printer User Guide</i> for information about print-media specifications or to order media.
The separation pad and the pick-up rollers might be worn out.	Replace the separation pad and pick-up rollers. See Table 3-1. Life expectancies of supplies for ordering information.

The printer does not respond when the Print command is selected in the software.

Cause	Solution
The printer experienced an error.	Check the control panel lights on the printer to determine if an error exists.
If no control panel lights are on, the printer is not receiving power.	<ol style="list-style-type: none"> 1. Check the power cable connection between the printer and the power source. 2. Check that the power switch is on. 3. Check that the power source (the wall outlet) is receiving power. 4. If the problem persists, replace the high-voltage power supply. 5. If, after replacing the high-voltage power supply, the problem persists, replace the dc controller.
The printer might be in Manual Feed mode (the Attention light is blinking and Go is light on).	Add media to tray 1 if it is empty. If media is already in the tray, press  (Go).
The wrong printer was selected in the software.	<ul style="list-style-type: none"> • In the Print or Printer Setup dialog box, make sure that the HP color LaserJet 2550 series printer is selected as the printer.
A jam might be present.	Clear any jams. See Clearing jams .
The printer is on a network and is not receiving a signal.	<ul style="list-style-type: none"> • Disconnect the printer from the network and attach it directly to a computer using a parallel or USB cable. • Clear any stopped jobs from the print queue. • Print a job that you know works. • Reinstall the printing software.
The interface cable between the computer (or network) and the printer is not connected properly.	Disconnect and reconnect the interface cable.

Table 6-10. Solving general printing problems (continued)**The printer does not respond when the Print command is selected in the software.**

Cause	Solution
The interface cable is defective.	<ul style="list-style-type: none"> • If possible, connect the interface cable to another computer (or network port) and print a job that you know works. • Try using a different cable.
If the printer is connected to a computer, the software for the printer is not configured for the printer port.	<ul style="list-style-type: none"> • Check the printer selection menu in the software to make sure it is using the correct port. If the computer has more than one port, make sure that the printer is associated with the correct one. • Remove all shared or third-party devices.

Pages print, but all colors do not print or the pages are completely blank.

Cause	Solution
One of the print cartridges might be low or empty.	Run an engine test (see Functional checks) to make sure that all four colors print. If not all colors print, replace one or more of the print cartridges. If the engine test is successful, replace the formatter.
If the printed pages are completely blank, the file might have blank pages.	Check the file to make sure that it does not contain blank pages.
A print cartridge might be low or empty.	Check the printer control panel for a Supplies Status message, or print a Supplies Status page, to see the levels remaining in the print cartridges. Replace any print cartridges that are low or empty. Messages are not created for non-HP print cartridges.
If you are using non-HP print cartridges, one or more print cartridges are low or empty. The control panel lights do not indicate low or empty for non-HP print cartridges.	Replace one or more of the print cartridges.
Font DIMM might be selected but the font DIMM is not physically installed in the printer. (This issue applies only when using an Asian-language font DIMM.)	In the settings for this printer, clear the Font DIMM check box on the Configure tab if no font DIMM is installed in the printer. Select the Font DIMM check box only if the font DIMM is physically installed in the printer. If you think that the font DIMM is installed, make sure that it is installed correctly.

The paper curls when exiting the top output bin.

Cause	Solution
The paper needs to print to the straight-through paper path.	Open the rear output door to print to the straight-through paper path. Remove each sheet as it exits the printer.

Table 6-10. Solving general printing problems (continued)**The paper curls when exiting the top output bin.**

Cause	Solution
The stack was slightly curled when it was placed in the tray.	Turn the stack over in the tray.
The paper does not meet specifications.	See the <i>HP Color LaserJet 2550 Series Printer User Guide</i> for information about print-media specifications.
If you are printing on light media, the Type setting might not be correct.	Select Light in the Type field in the printer driver.

The printer prints, but the text is wrong, garbled, or incomplete.

Cause	Solution
Not enough power is supplied to the printer because the printer is plugged into a power strip or a UPS.	Plug the printer power cord directly into a wall outlet.
The interface cable is loose or defective.	Disconnect the printer cable and reconnect it. Try a print job that you know works. If possible, attach the cable and printer to another computer and try a print job that you know works. Finally, try a new cable.
The printer is on a network or sharing device and is not receiving a clear signal.	Disconnect the printer from the network or shared drivers and attach it directly to a computer using a parallel cable or USB cable. Print a job that you know works.
The wrong driver was selected in the software.	In the Print or Printer Setup dialog box, make sure that the HP color LaserJet 2550 series printer is selected as the printer and that the appropriate port is selected.
The printer driver is malfunctioning.	Print a page from the HP LaserJet Toolbox. If the page prints, then the problem is in the printer driver. Uninstall and reinstall the printer driver.
The program is malfunctioning.	Try printing a job from another program.

Table 6-10. Solving general printing problems (continued)

The printer prints, but the text is wrong, garbled, or incomplete.

Cause	Solution
If the printer is connected to a computer, the operating system is malfunctioning.	<p>Check the operating system.</p> <hr/> <p>Note</p> <p>This method works only with Windows 98, NT 4.0, and 2000 operating systems, and the computer must be connected to a parallel cable. If you do not know how to use this method, see the documentation that came with the computer.</p> <p>Restart the computer. When it beeps during startup, press F5 and select Command Prompt Only. At the C:\ prompt on the computer, type <code>Dir<LPT1</code> and then press Enter. (This assumes that the printer is connected to LPT1.) If the Go light comes on at the printer, press  (Go) to print and eject the page. If the page prints correctly, then the operating system is malfunctioning.</p>
Font DIMM might be selected but the font DIMM might not be physically installed in the printer. (This issue only applies when an Asian-language font DIMM is installed.)	In the settings for this printer, clear the Font DIMM check box on the Configure tab if no font DIMM is installed in the printer. Select the Font DIMM check box only if the font DIMM is physically installed in the printer. If you think that the font DIMM is installed, make sure that it is installed correctly.

Solving PostScript (PS) errors

The following situations are specific to the PS language and might occur when several printer languages are being used.

Note

To receive a printed or an onscreen message when PS errors occur, select this option in the PS printer driver or the HP LaserJet Toolbox.

The job prints in Courier (the printer default typeface) instead of the typeface you requested.

Cause	Solution
The requested typeface is not downloaded. A personality switch might have been performed to print a PCL job just before the PS printing job was received.	Download the font you want to use and send the print job again. Verify the type and location of the font. Download the font to the printer, if applicable. See the software documentation.

A PS error page prints.

Cause	Solution
The print job might not be a PS job.	Make sure the print job is a PS job. Check to see whether the program expected a setup or PS header file to be sent to the printer.

VM Error

Cause	Solution
This is a PS font error that occurs when you are using several fonts.	<ul style="list-style-type: none">• Select Unlimited Downloadable Fonts in the printer driver.

Range Check

Cause	Solution
The tray settings are incorrect.	<ul style="list-style-type: none">• Try printing from a different tray.• Select Unlimited Downloadable Fonts in the printer driver.

Limit Check

Cause	Solution
The printer is out of memory.	<ul style="list-style-type: none">• Reduce the complexity of the page.• Use one of the other printer drivers.• Send the print job in smaller pieces with a fewer number of pages.• Install more memory.

Solving common Macintosh problems



In addition to the problems listed in [Solving general printing problems](#), this section lists problems that can happen only when using the Mac OS, versions 9.1, 9.2, 9.3, and OS X, v. 10.1 and later.

Table 6-11. Problems in the Chooser

The printer driver icon does not appear in the Chooser (when using Mac OS, version OS X).

Cause	Solution
The software was not installed correctly.	The LaserWriter driver should be present as a part of the Mac OS. Make sure that the LaserWriter driver is in the Extensions folder within the systems folder. If not, install the LaserWriter driver from your Mac OS CD-ROM.
The interface cable might not be of high quality.	Make sure that you are using a high-quality interface cable.
An incorrect network might be selected.	Make sure that the printer is on the correct network. Select Network under Control Panels in the Apple menu and then select the correct network.

Table 6-11. Problems in the Chooser (continued)**The printer name does not appear in the Select a PostScript Printer box in the Chooser.**

Cause	Solution
The printer might not be ready.	Make sure that the cables are connected correctly, the printer is on, and the Ready light is on.
The correct printer driver might not be selected.	Make sure that the correct printer driver has been selected in the Chooser (for example, LaserWriter).
An incorrect zone might be selected.	If the printer resides on a network that has multiple zones, make sure that the correct zone is selected.
The PS driver might not be installed.	Verify that the PS driver is installed.
The printer might not be selected in the Chooser.	Print a Configuration page to make sure that the printer has been selected in the Chooser. [Simultaneously press  (Go) and  (Cancel Job) on the printer.]

The printer driver does not automatically set up the selected printer even though you clicked Auto Setup in the Chooser.

Cause	Solution
The software was not installed correctly.	Reinstall the printer software. See the <i>HP Color LaserJet 2550 Series Printer Getting Started Guide</i> .

Table 6-12. Printing Errors**A print job was not sent to the printer that you wanted.**

Cause	Solution
Another printer with the same or similar name might have received your print job.	<ul style="list-style-type: none"> • Check the name of the printer that appears on the Configuration page. • Make sure that the cables are connected correctly, the printer is on, and the Ready light is on.

You cannot use the computer while the printer is printing.

Cause	Solution
Background Printing has not been selected.	For LaserWriter 8.6 and later: Turn Background Printing on by selecting Print Desktop on the File menu and then clicking Background Printing .

Table 6-12. Printing Errors (continued)

An encapsulated PostScript (EPS) file does not print with the correct fonts.

Cause	Solution
This problem occurs with some programs.	<ul style="list-style-type: none">• Try downloading the fonts contained in the EPS file to the printer before printing.• Send the file in ASCII format instead of a binary encoding.

Your document is not printing with New York, Geneva, or Monaco fonts.

Cause	Solution
The printer might be substituting fonts.	Select Options in the Page Setup dialog box to clear the substituted fonts.

Table 6-13. USB Problems

You are unable to print from a third-party USB card.

Cause	Solution
This error occurs when the software for USB printers is not installed.	When adding a third-party USB card, you might need the Apple USB Adapter Card Support software. The most current version of this software is available from the Apple Web site.

Table 6-13. USB Problems (continued)

When connected using a USB cable, the printer does not appear in the Macintosh Chooser after the driver is selected.

Cause	Solution
This problem is caused by either a software or hardware component.	<p data-bbox="928 262 1321 296">Software troubleshooting</p> <ul data-bbox="928 315 1449 520" style="list-style-type: none">• Make sure that your Macintosh supports USB.• Verify that your Macintosh has Mac OS 9.1, 9.2, 9.3, or OS X, v. 10.1 or later.• Make sure that your Macintosh has the appropriate USB software from Apple. <hr/> <p data-bbox="928 546 986 571">Note</p> <p data-bbox="928 590 1441 674">The iMac and Blue G3 desktop Macintosh systems meet all of the requirements to connect to a USB device.</p> <hr/> <p data-bbox="928 737 1331 770">Hardware troubleshooting</p> <ul data-bbox="928 789 1453 1287" style="list-style-type: none">• Make sure that the printer is turned on.• Make sure that the USB cable is properly connected.• Make sure that you are using the appropriate high-speed USB cable.• Make sure that not too many USB devices are drawing power from the chain. Disconnect all devices from the chain and connect the cable directly to the USB port on the host computer.• Check to see if more than two non-powered USB hubs are connected in a row on the chain. Disconnect all devices from the chain and connect the cable directly to the USB port on the host computer. <hr/> <p data-bbox="928 1312 986 1337">Note</p> <p data-bbox="928 1356 1441 1381">The iMac keyboard is a non-powered USB hub.</p>

Manually rotating the print-cartridge carousel

CAUTION

Before working on the carousel, turn off the printer.

Under normal conditions, pressing  (**Rotate Carousel**) brings another print cartridge to the top position. However, if the carousel does not rotate, then rotate the print-cartridge carousel manually.

Note

All models of the HP color LaserJet 2550 printer contain a guide that is designed for access to the carousel brake.

To manually rotate the print-cartridge carousel

CAUTION

Manually rotating the print-cartridge carousel when power is supplied to the printer can damage the printer. Turn the printer off and disconnect the power cord before performing this procedure.

1. Open the top cover.
2. Press the end of a paper clip into the guide (callout 1) to lift up the carousel brake.
3. Rotate the carousel manually.

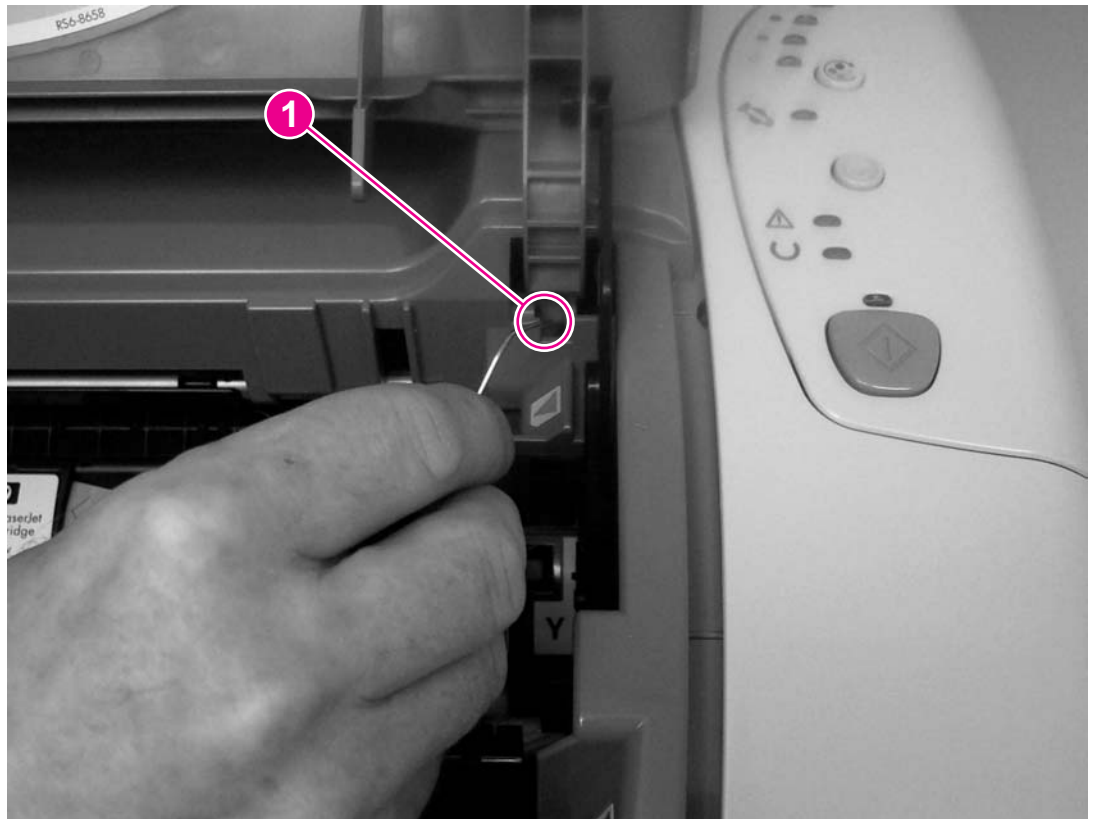

Figure 6-2. Manually rotating the print-cartridge carousel

Functional checks

An engine test can help to identify printing problems, and a paper-path check can help to identify problems in the paper path.

Engine test

The engine test is used to verify that the print engine is functioning correctly. The formatter is bypassed during an engine test, so the engine test is useful for isolating printer problems. Because the engine test prints horizontal lines along the entire printable area of a page, it is also useful for checking and adjusting registration.

Note

The type of engine test and the input tray depend on the last print job. During the engine test, the printer pulls media from the input tray that was used for the last print job. The last print job also defines the type of engine test. If the last print job was a color print job, then a color engine test is performed. If the last print job was a black-only print job, then a black-only engine test is performed.

Printing an engine test

The engine test switch is inside tray 1, on the left side, just below the front cover.

To print an engine test:

1. Turn off the printer.
2. Turn on the printer.
3. Open tray 1 and load paper.
4. Press the engine-test switch (shown below).

Note

The formatter must be connected to the ECU to perform an engine test. Otherwise, the printer does not print the engine test.

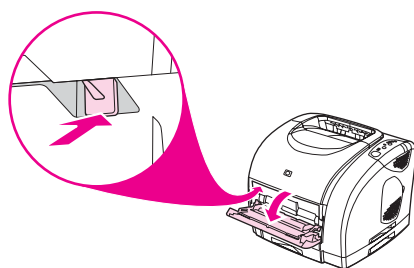



Figure 6-3. Location of the engine-test switch

Performing a continuous self-test

1. Turn the printer off.
2. Press and hold  (Go).

3. Turn the printer on and continue to hold  (**Go**) for at least 20 seconds, but fewer than 30 seconds.

Note

The Attention and Ready lights turn on during the continuous self-test.

4. Release  (**Go**). The device lights begin cycling from front to back. The self-test process runs until the printer is in the Ready state.

Note

This test is similar to the NVRAM initializer; for more information see [NVRAM initializer](#).

5. To terminate the continuous self-test, press  (**Cancel Job**).

High-voltage power-supply check

The high-voltage power-supply PCA provides the necessary voltages for the electrophotographic processes.

To check the print cartridge connection points

1. Turn the print cartridge over and visually inspect the two connection points on the ends of the print cartridge. If they are dirty or corroded, clean the connections. If they are damaged, replace the print cartridge.

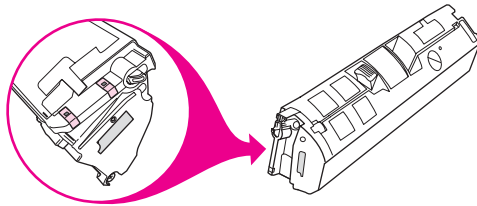

Figure 6-4.

Print cartridge high-voltage connection points

2. If the connection points are dirty or corroded, then clean the connections. If they are damaged, then replace the print cartridge.

Note

Use only isopropyl alcohol to clean the connections.

Paper-path check

If media is not being picked up or is not moving through the paper path, you might want to observe all of the paper-motion activities. Override the door interlock (SW301) and the laser/scanner switch to observe the following actions:

- Motor rotation
- Solenoid action
- Pickup-roller motion
- Drive-roller, transfer-roller, fuser-roller and gear, and delivery-roller motion

To override SW301

1. Push a piece of heavy paper into the slot in the top cover (callout 1) to override SW301.

To override the laser/scanner switch

1. Use a small flatblade screwdriver to override the laser/scanner switch (callout 2).

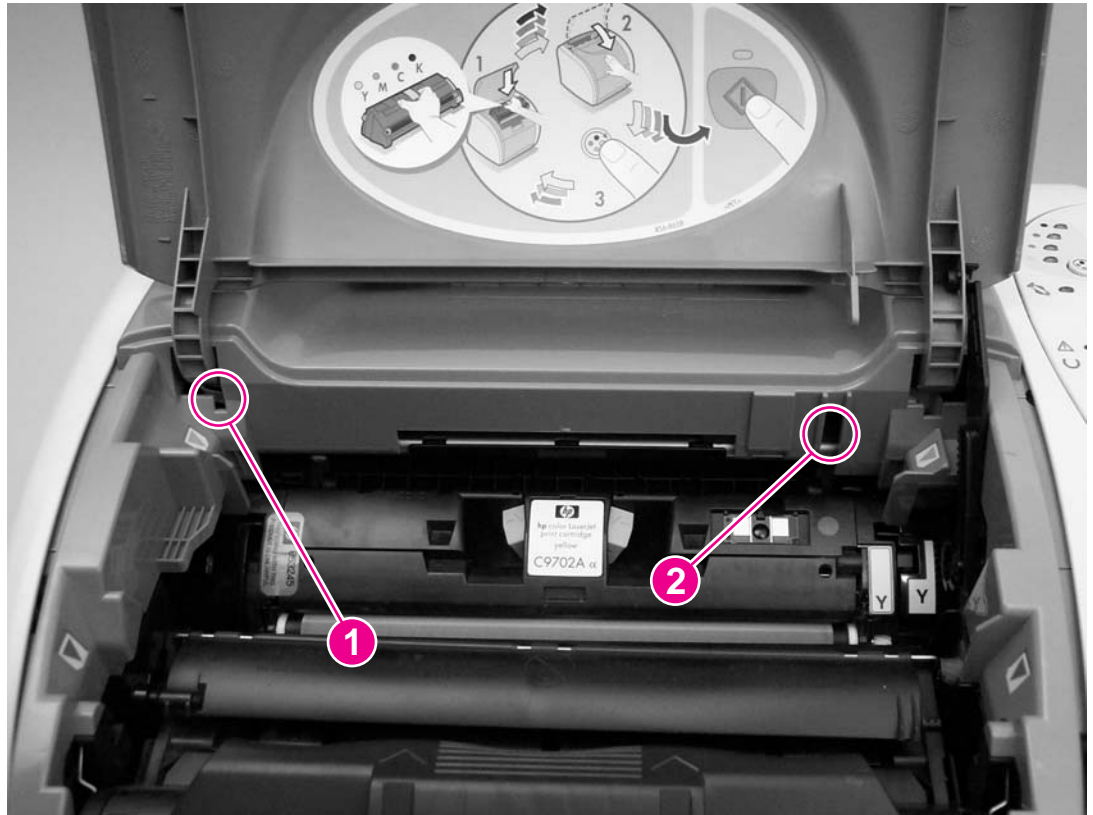

Figure 6-5. Overriding SW301 and the laser/scanner switch



Service mode functions

Service mode functions that appear in this section should be performed by trained service personnel.

Cold reset

A cold reset sets most, but not all, default variables stored in NVRAM back to factory default values. It typically does not reset the page count, paper tray sizes, localization language, or formatter number. To reset all variables, see [NVRAM initializer](#).

To perform a cold reset

1. Turn the printer off.
2. Press and hold  (**Go**).
3. Turn the printer on and continue to hold  (**Go**) for at least 10 seconds, but for fewer than 20 seconds.

Note

The Attention light turns on during a cold reset.

4. Release  (**Go**).

Note

If either the Go or Ready light turned off or no lights turned off before releasing  (**Go**), then repeat steps 1 through 5.

5. The printer lights begin cycling from front to back. The cold-reset process runs until the printer is in the Ready state.

NVRAM initializer

NVRAM initializer sets all default variables stored in NVRAM back to factory default values or to a default ROM value, depending on the variable. It also performs a system reset.

NVRAM initializer resets the following:

- All menu settings to factory default values
- Factory settings such as formatter number, page counts, and factory paper settings

Note



Jetdirect NVRAM is *not* reset by performing an NVRAM initialization.

To perform an NVRAM initialization

Note

If possible, print a Configuration page before performing an NVRAM initialization. The Configuration page contains the information needed to restore the printer data.

1. Turn the printer off.
2. Press and hold  (**Go**).

3. Turn the printer on and continue to hold  (**Go**) for at least 30 seconds, but fewer than 40 seconds.
4. Release  (**Go**).

Note

The Attention, Ready, and Go lights are on during an NVRAM initialization.

5. The device lights will begin cycling from front to back. The NVRAM-initialization process runs until the printer is in the Ready state.



Note

This process is similar to a continuous self-test. For more information, see [Functional checks](#).

After the initialization is complete, you can use PJL commands to restore some of your printer settings (see [Using PJL commands](#)).

Error report

Use the following steps to print an error report:

1. Turn the printer off.
2. Press and hold  (**Go**).
3. Turn the printer on and continue to hold  (**Go**) for at least 40 seconds, but fewer than 50 seconds.
4. Release  (**Go**).



Note

The Attention light turns off during the error report process.

The printer prints an error report.

Super NVRAM initialization

Use the following steps to perform a super NVRAM initialization:



1. Turn off the printer.
2. Press and hold  (**Go**).
3. Turn the printer on and continue to hold  (**Go**) for at least 50 seconds.
4. Release  (**Go**).

Note

The Ready light turns on during a super NVRAM initialization.

Network card cold reset

Use the following steps to perform a network card cold reset.

1. Make sure that the printer is in the Ready state.
2. Press  (**Rotate Carousel**) and  (**Cancel Job**) simultaneously.

Note

There is no visual feedback from a network card cold reset.

Using PJL commands

PJL commands are useful when you have performed an NVRAM initialization or replaced the formatter. After you perform an NVRAM initialization, restore the serial number, page counts, color page counts, and formatter number.

Use the MS-DOS Editor to create a file (or files) to send directly to the printer to restore printer data.

Note

To send PJL commands directly to the printer, the printer must be directly connected to the computer using an IEEE-1284-compliant parallel cable. PJL commands cannot be sent to the printer by using a USB or a network connection.

Use the following PJL commands to restore the printer information to the new formatter:

```
ESC%-12345X@PJL SET SERVICEMODE=HPBOISEID
@PJL DEFAULT SERIALNUMBER=XXXXXXXXXXXX
@PJL DEFAULT PAGES=XXX
@PJL DEFAULT COLORPAGES=XXX
@PJL SET SERVICEMODE=EXIT
ESC%-12345X
```

The X's in the serial number, formatter number, pages, and color pages fields are variables that you must replace with your printer information. The Configuration page contains the actual information for your printer.

Using the MS-DOS command prompt and the MS-DOS Editor

To enter the PJL commands, you must use the MS-DOS Command Prompt and MS-DOS Editor.

To open an MS-DOS command prompt window in Windows 2000 and Windows XP:

1. Click **Start** and then click **Run**.
2. Type `cmd` and then click **OK**.
An MS-DOS command prompt window opens.
3. At the command prompt, type `cd\` and then press **Enter**.

To open an MS-DOS command prompt window in Windows ME

1. Click **Start**, click **Programs**, click **Accessories**, and then click **MS-DOS Prompt**.
An MS-DOS command prompt window opens.
2. At the command prompt, type `cd\`, and then press **Enter**.

To open an MS-DOS command prompt window in Windows 98

1. Click **Start**, click **Programs**, and then click **MS-DOS Prompt**.
An MS-DOS command prompt window opens.
2. At the command prompt, type `cd\`, and then press **Enter**.

To open a file in the MS-DOS Editor:

1. At the command prompt (C:\>), type `EDIT PJJREST` and then press **Enter**.

The MS-DOS Prompt Edit file window opens.

To create the escape (Esc) sequence in the MS-DOS Editor:

1. Press **Ctrl+P** and then release the keys.
2. Press and release the **Esc** key. The editor inserts an arrow symbol pointing to the left, which indicates to the printer that the text following the symbol is a command, not text that should be printed.

Note

A left-arrow symbol should appear, which indicates to the printer that the text following the symbol is a command. If the left-arrow symbol does not appear, or if another symbol appears, then delete any characters or spaces and repeat steps 1 and 2 until the left-arrow symbol appears.

3. Type, in uppercase letters, the remainder of the command after the symbol.

Hint

Following is an example of the MS-DOS Editor window, when restoring the serial number.

```
[left-arrow]%-12345X@PJL SET SERVICEMODE=HPBOISEID
@PJL DEFAULT SERIALNUMBER=XXXXXXXXXX
@PJL DEFAULT SERVICEMODE=EXIT
[left-arrow]%-12345X
```

To save the PJJREST file:

1. Press **Alt+F** to open the **File** drop-down menu.
2. Use the cursor-down key to highlight **Exit**, and then press **Enter**.
3. If Save-File reads "C:\PJJREST," and a flashing cursor highlights **Yes**, then press **Enter**.
After pressing **Enter**, the command prompt (C:\>) appears.

To send the file to the printer:

1. Make sure that the printer is in the Ready state.
2. At the command prompt (C:\>), type `copy PJJREST [printer port]`. For example, `copy PJJREST LPT1`.
3. Press **Enter**.
The data light on the printer should flash. When complete, the printer returns to Ready and the MS-DOS window displays the command prompt.
4. To return to Windows, type `exit` and then press **Enter**.
5. Print a Configuration page to verify that the printer information is restored.

Troubleshooting tools

Information pages, repetitive defect measurements, timing charts, and cable connection diagrams are useful tools in solving printer problems.



Demo page

To print the Demo page, press  (**Go**) when the printer is Ready (Ready light on) and is not printing. You can also view this page from the HP LaserJet Toolbox.

Configuration page

The Configuration page lists current settings and properties of the printer. You can print a Configuration page at the printer control panel or from the HP LaserJet Toolbox.

To print a configuration page

To print the Configuration page from the printer, press  (**Go**) and  (**Cancel Job**) simultaneously. The Supplies Status page also prints. If you have an HP Jetdirect print server card installed, the HP Jetdirect page listing the HP Jetdirect information also prints.

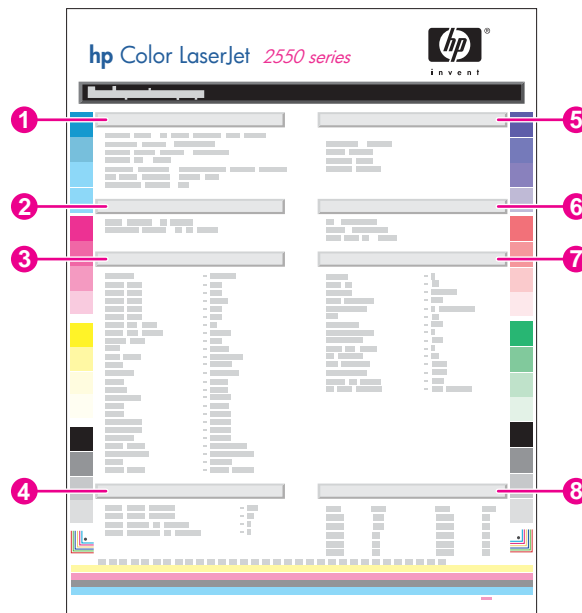



1. **Product Information.** This section contains basic information about the printer, such as the product name and serial number.
2. **Memory.** This section lists memory-related information, such as the total memory that is installed.
3. **Paper Settings.** This section lists information about the media type for each tray and about the type settings for all of the media that the printer supports.
4. **Page Counts.** This section lists the total number of pages printed, the number of color pages printed, and information about jams.

5. **Product Settings.** This section lists information that is gathered during software installation, including the language and the company name.
6. **Installed personalities and options.** This section contains information about optional items that might be installed, such as DIMMs or an HP Jetdirect print server.
7. **Print Settings.** This section contains information about printer settings that are configured in the printer driver or in the HP LaserJet Toolbox.
8. **Status Log.** This section contains information about printer errors.

Supplies Status page

The Supplies Status page lists the remaining life of HP print cartridges and HP imaging drums. It also lists the estimated number of pages remaining, number of pages printed, and other supplies information. You can print a Supplies Status page at the printer control panel or from the HP LaserJet Toolbox.

To print at the printer, press  (**Go**) and  (**Cancel Job**) simultaneously. (The Configuration page also prints, and, if you have an HP Jetdirect print server installed, the HP Jetdirect page that lists the HP Jetdirect information also prints.)

Note

Supplies information is also available through the HP LaserJet Toolbox.

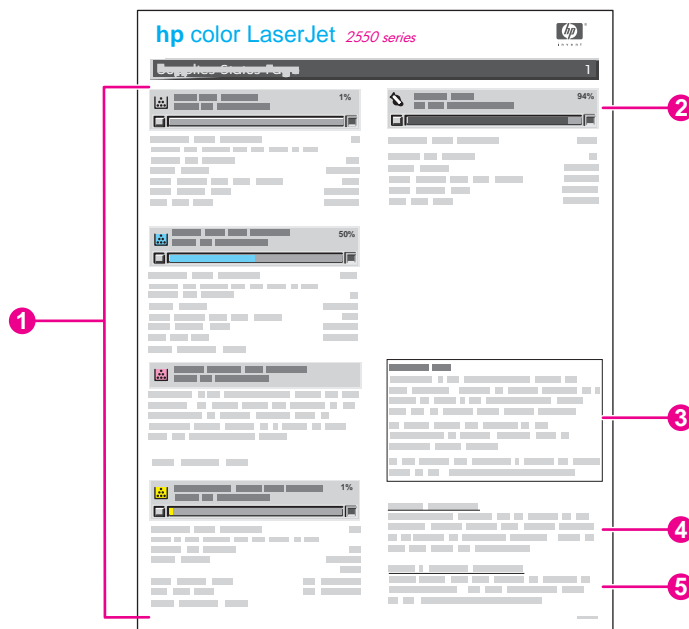

1. **Print-cartridge area.** This area contains a section for each of the print cartridges and provides information about HP print cartridges. This information includes the part number for each print cartridge, whether each print cartridge is low, and the life remaining for each print cartridge expressed as a percentage, as a graphic, and as the estimated number of pages remaining. This information is provided only for HP supplies. If a non-HP supply is installed, you see an alert message instead.
2. **Imaging-drum area.** This area contains the same information for the imaging drum that the print-cartridge area provides for the print cartridges.

3. **Warranty Note.** This section contains information about how the printer warranty is affected when you use non-HP supplies. It also requests that you call the HP fraud hotline if a supply that is being detected as a non-HP supply was sold to you as a genuine HP supply. (See the *HP Color LaserJet 2550 Series Printer User Guide* for information about the HP fraud hotline.)
4. **Ordering Information.** This section contains basic information about how to order new HP supplies.
5. **Recycling Information.** This section contains information about the Web site you can visit for information about recycling.

Repetitive image defects

Use a ruler to measure occurrences of repetitive image defects to help solve image quality problems. Place the ruler next to the first occurrence of the defect on the page. Find the distance between identical defects and see [Table 6-14. Repetitive image defects](#) to identify the component that is causing the defect.

Table 6-14. Repetitive image defects

Measurement	Component
22.1 mm (.87 inch)	Pre-ICL roller
33.9 mm (1.33 inches)	Developer sleeve
37.9 mm (1.49 inches)	ICL roller
38.1 mm (1.50 inches)	Charge roller
41.9 mm (1.65 inches)	RS roller
44.3 mm (1.74 inches)	T1 transfer
56.9 mm (2.24 inches)	T2 transfer
66.6 mm (2.62 inches)	Pressure roller
75.6 mm (2.98 inches)	Fuser film
89.0 mm (3.50 inches)	Transfer belt drive roller
90.0 mm (3.54 inches)	Transfer belt tension roller
148.3 mm (5.84 inches)	Cartridge drum

General timing charts



Figure 6-6. General timing chart--WAIT period

- Timing chart for printing on one normal paper in the mono color mode (normal speed)

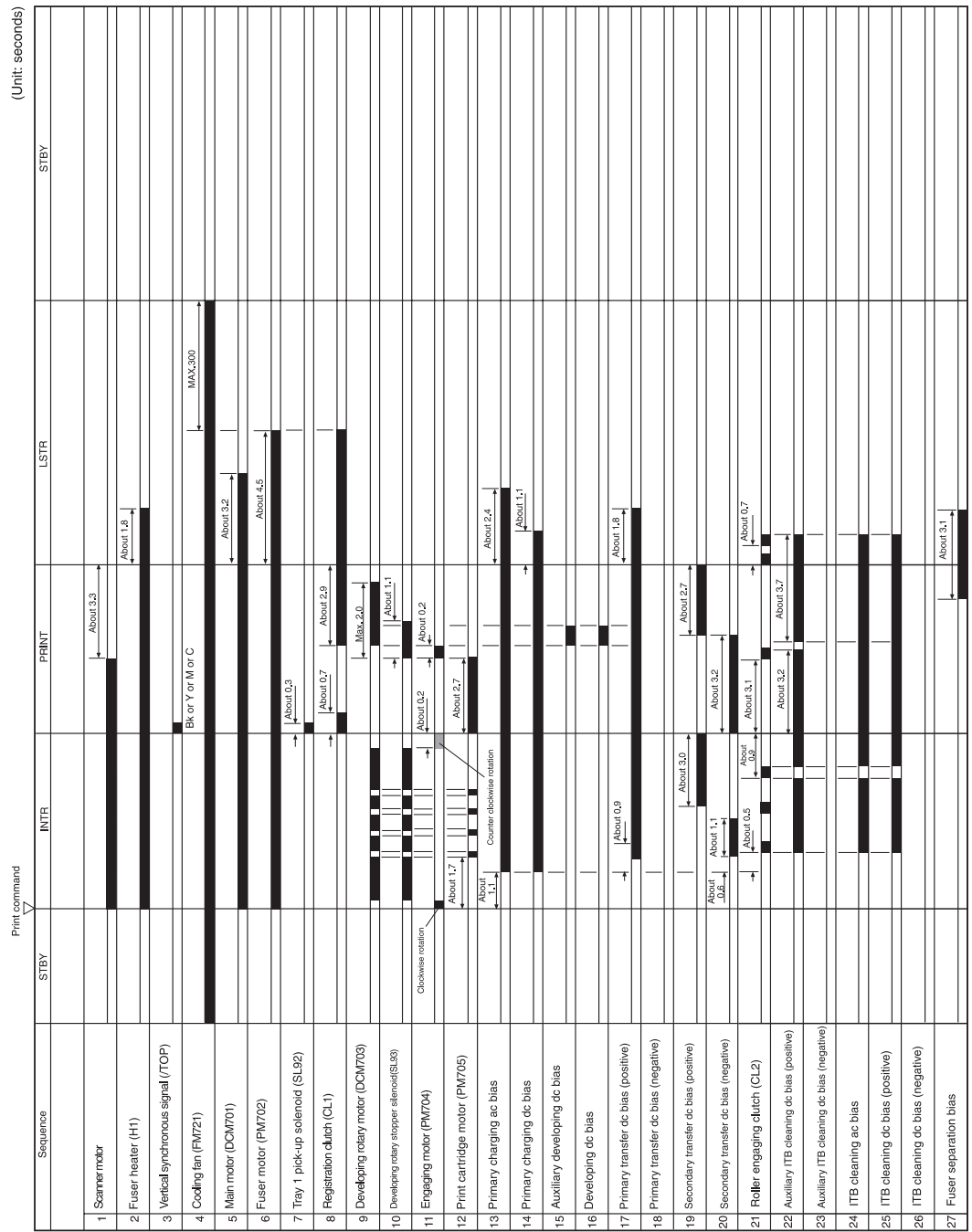

Figure 6-7. General timing chart--one page, full-color, normal speed

Locations of connectors

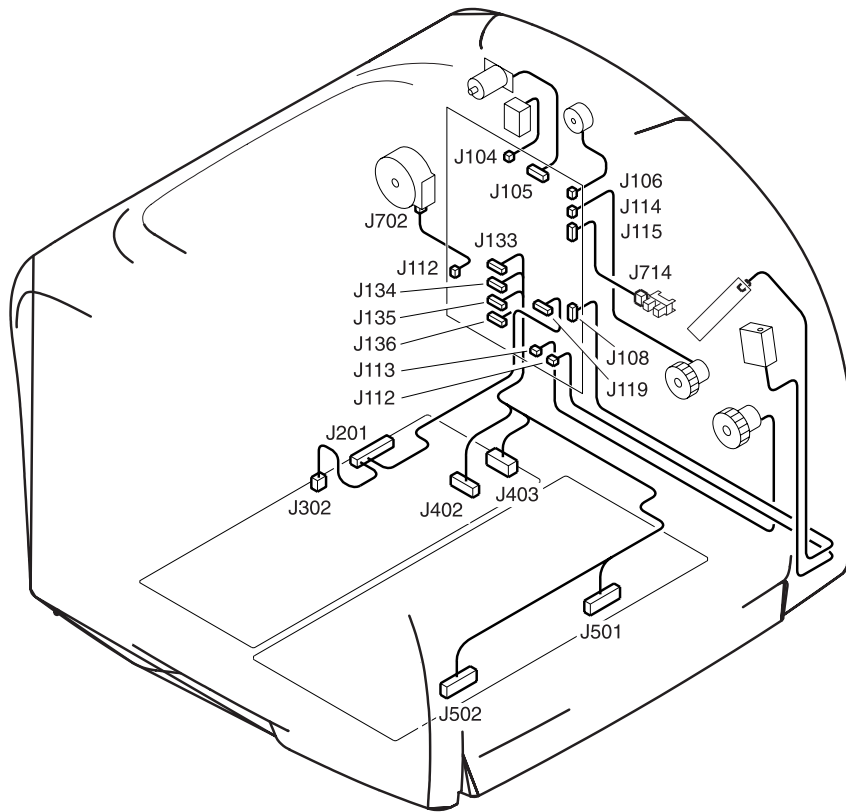

Figure 6-8. Locations of printer connectors (1 of 3)

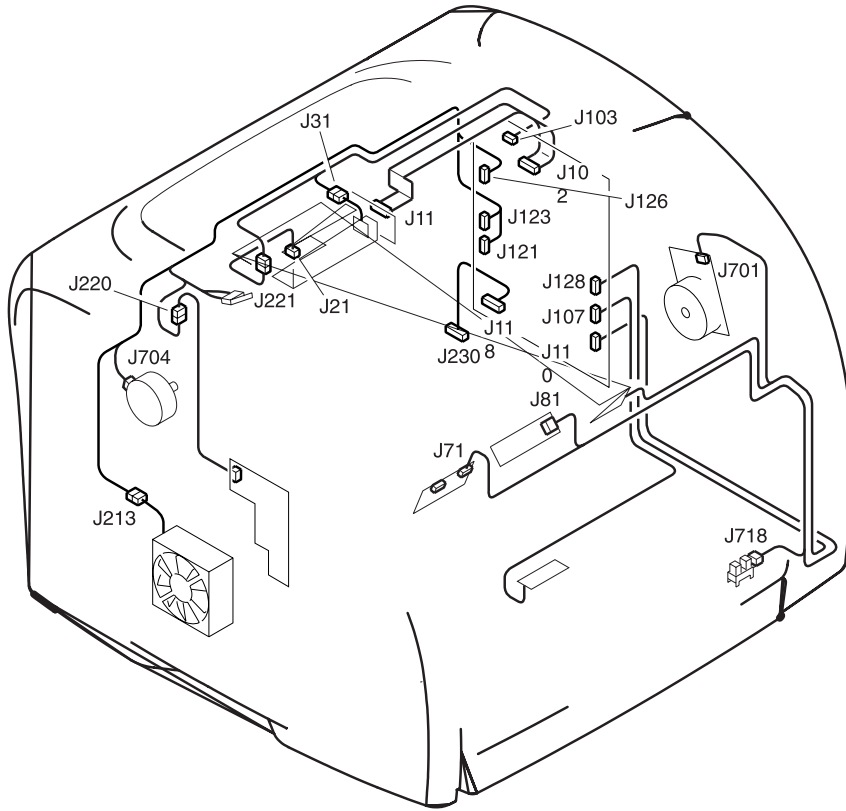

Figure 6-9. Locations of printer connectors (2 of 3)

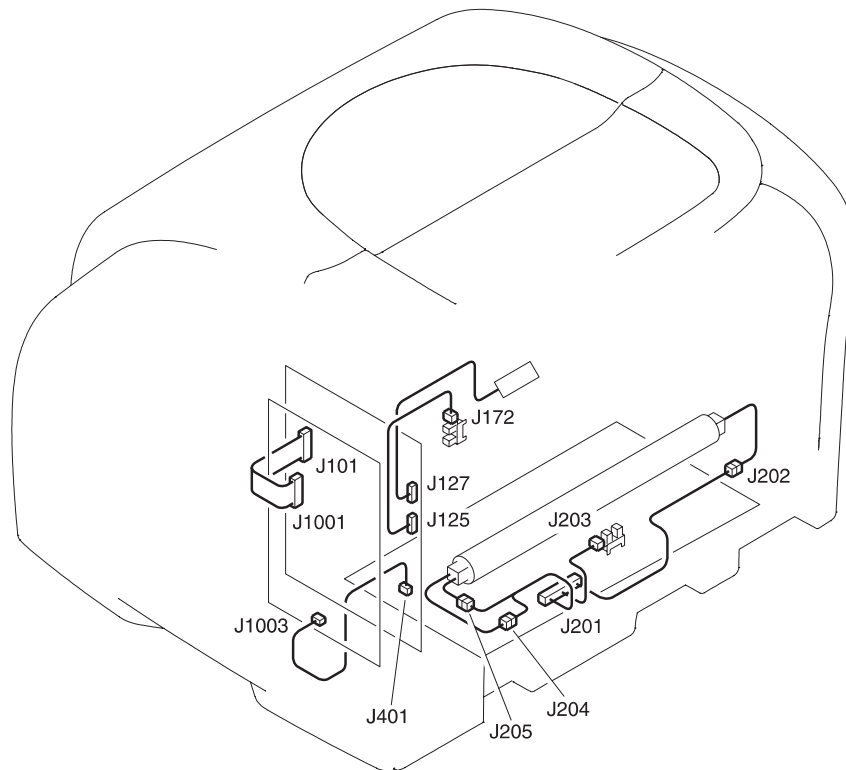

Figure 6-10. Locations of printer connectors (3 of 3)

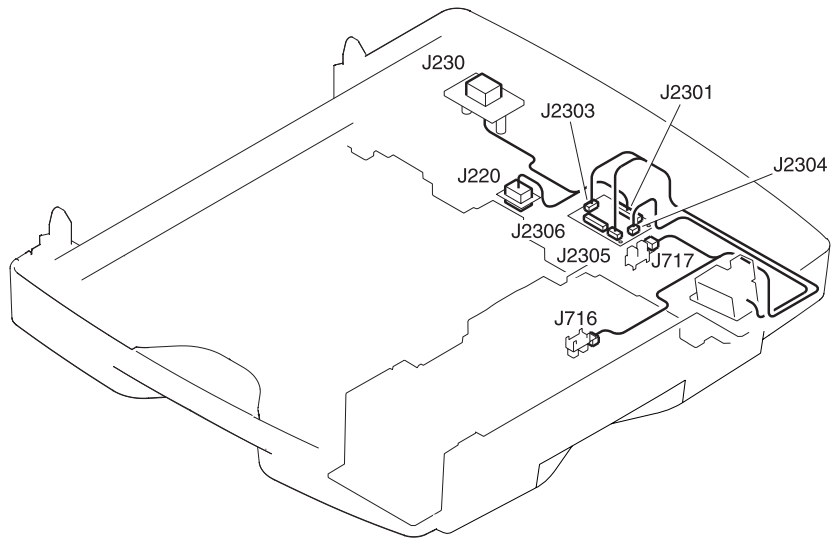

Figure 6-11. Locations of 250-sheet tray connectors

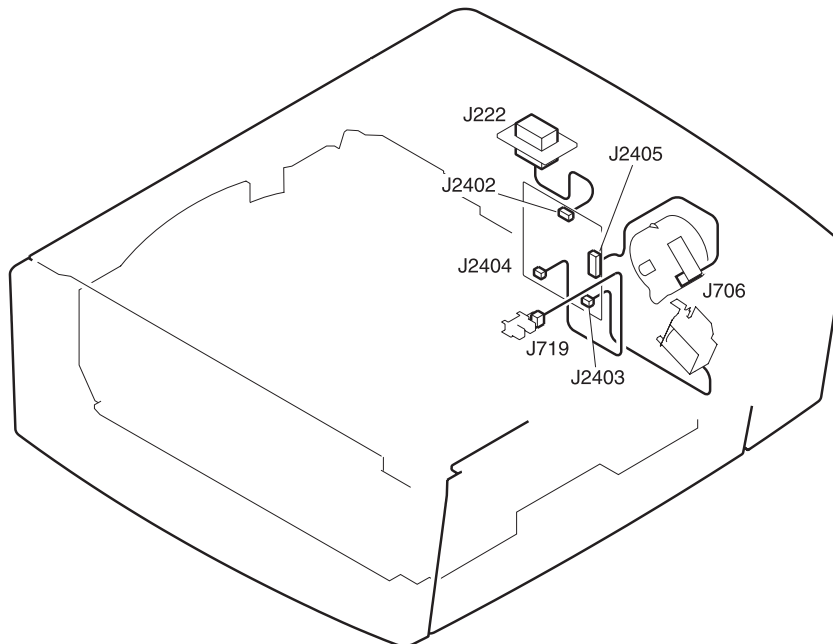

Figure 6-12. Locations of 500-sheet tray connectors

Dc controller connections

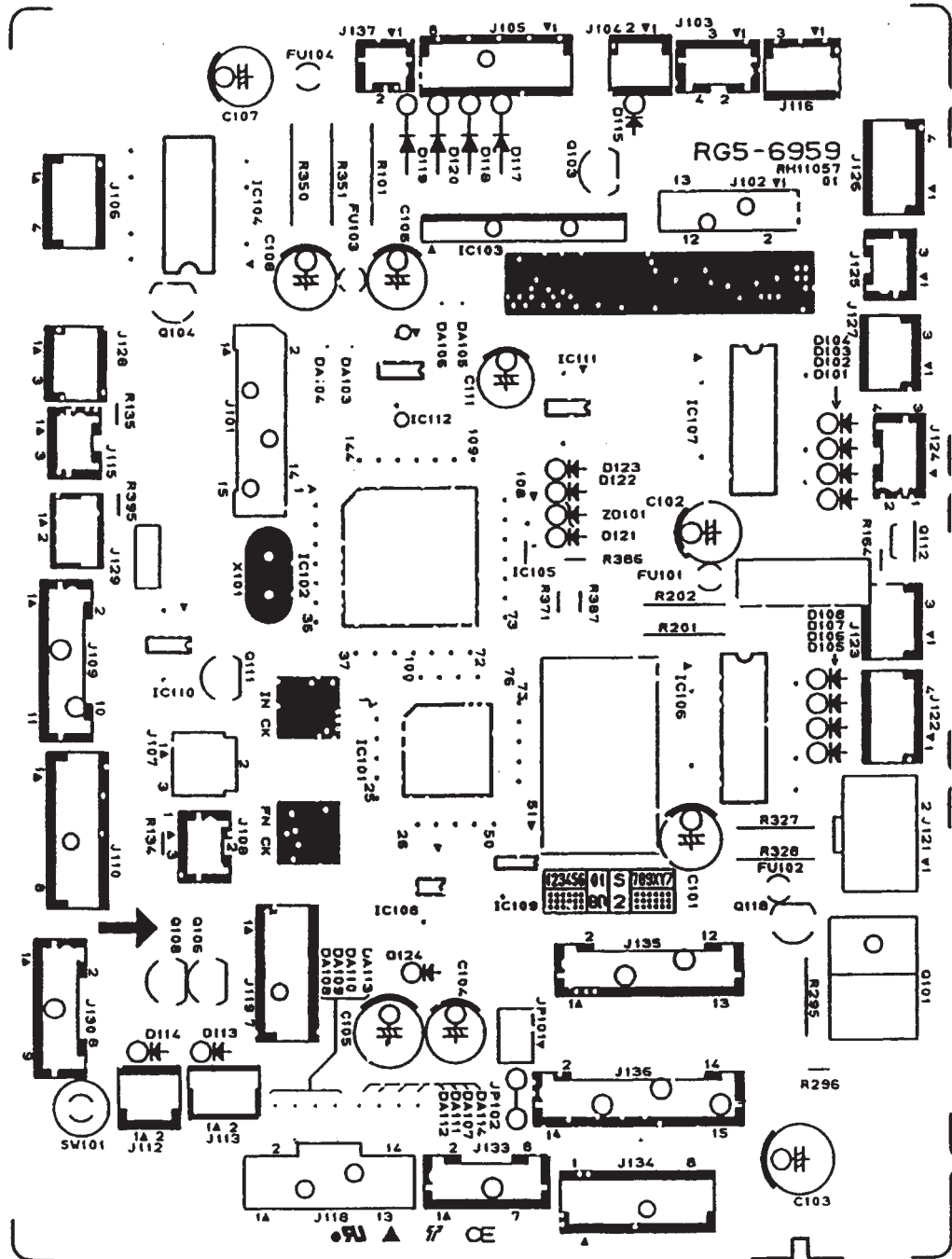

Figure 6-13.

Dc controller connections

Main wiring diagram

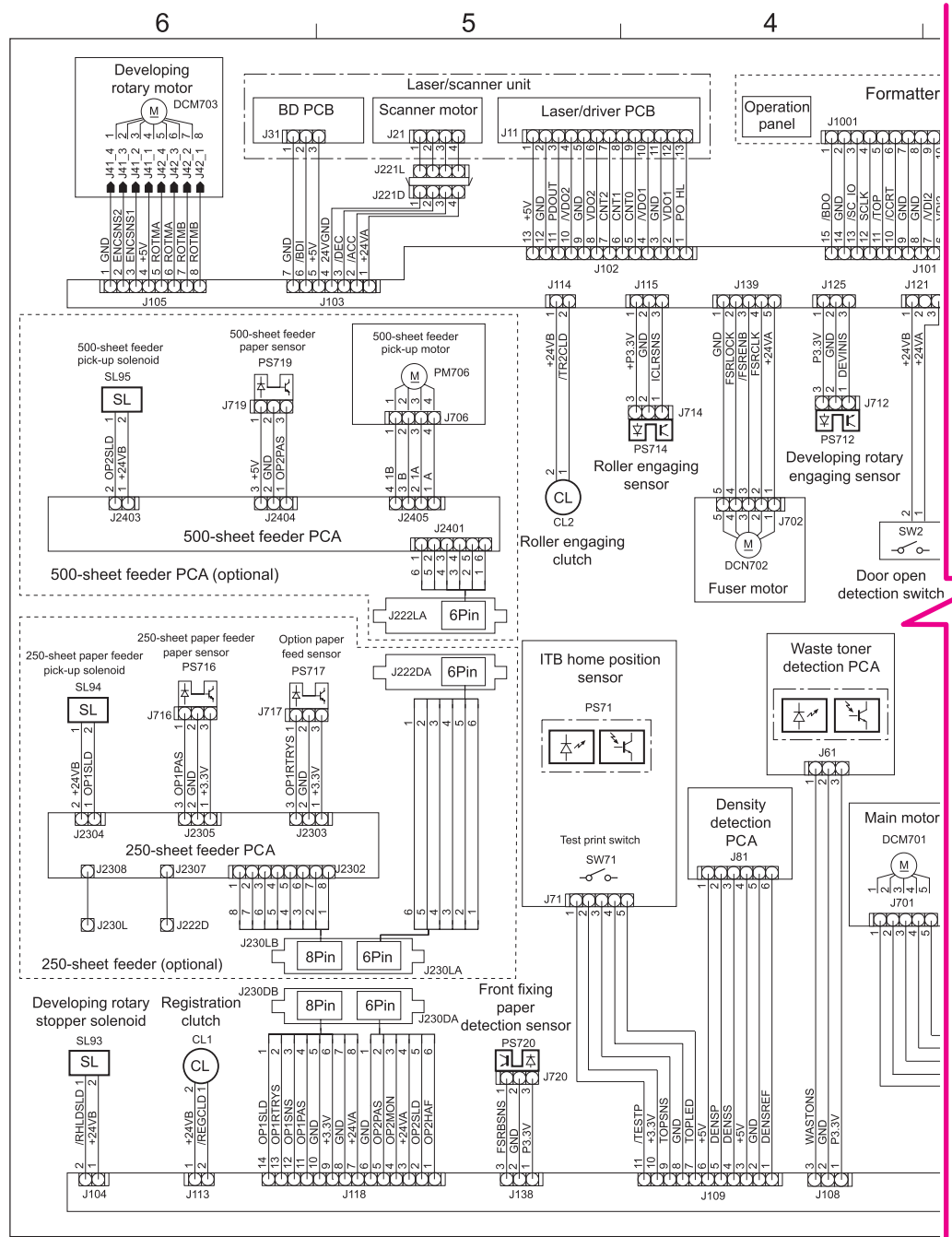

Figure 6-14. Main wiring (1 of 2)

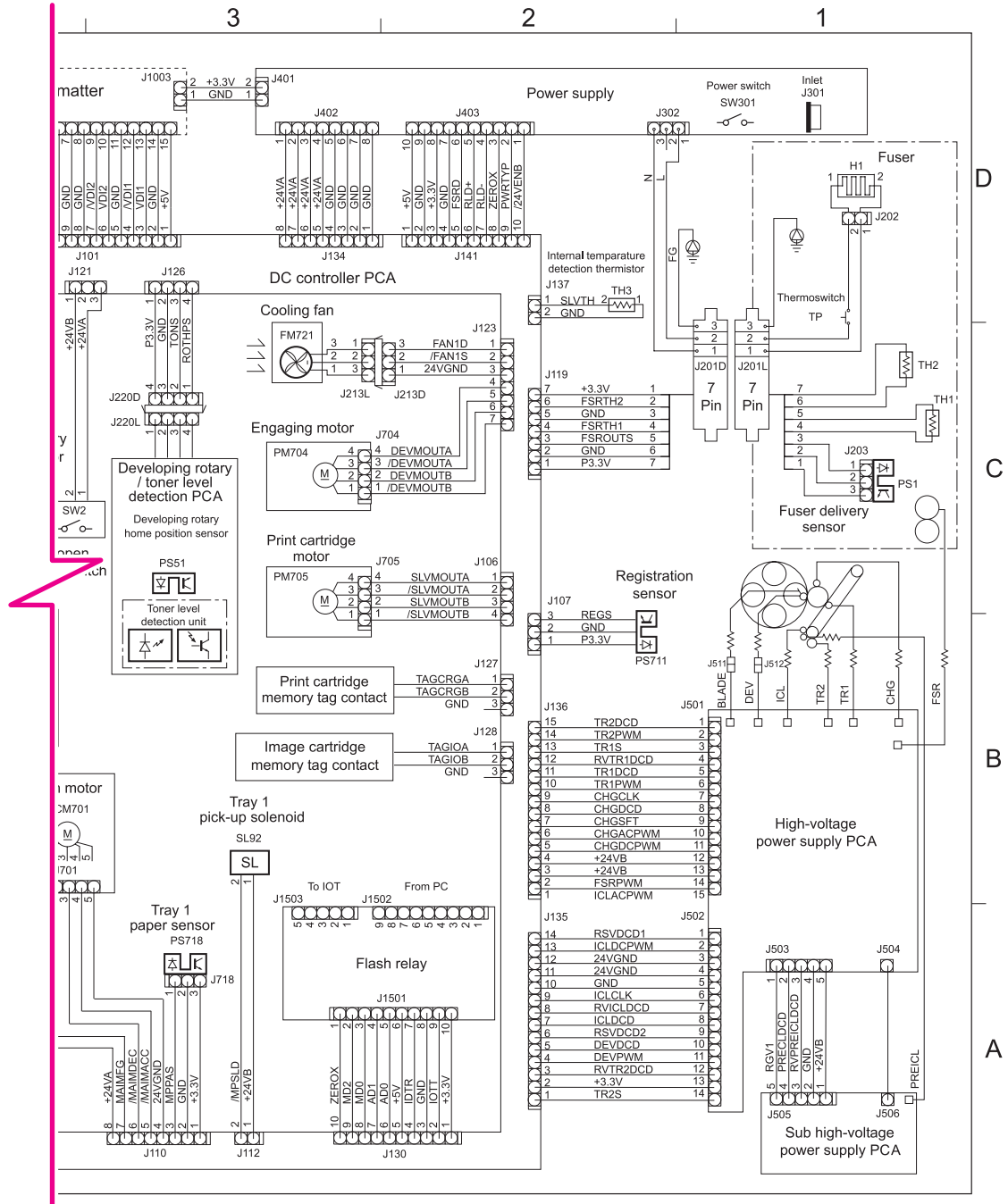

Figure 6-15.

Main wiring (2 of 2)

HP LaserJet Toolbox

The HP LaserJet Toolbox is only supported for Windows 98, Me, 2000, and XP and in Mac OS X, v. 10.2 or later. You must have performed a complete software installation to use the HP LaserJet Toolbox.

You can view the HP LaserJet Toolbox when the printer is directly connected to your computer or connected to the network. The HP LaserJet Toolbox is a Web page that opens in a Web browser and provides access to the embedded Web server, printer documentation, and printer management and troubleshooting tools.

You do not have to have Internet access to open and use the HP LaserJet Toolbox. However, if you click a link in the **Other Links** area, you must have Internet access in order to view the site associated with the link.

To use the HP LaserJet Toolbox, you must have one of the following browsers:

- For Windows: Microsoft Internet Explorer 5.5 or later, Netscape Navigator 6.2 or later, or Opera Software ASA Opera 7 or later.
- For Macintosh (OS X only): Microsoft Internet Explorer 5.1 or later, Netscape Navigator 6.23 or later, or Safari 1.0.

All pages can be printed from the browser.

To view the HP LaserJet Toolbox

1. Open the HP LaserJet Toolbox in one of these ways:
 - On the Windows desktop, double-click the **HP LaserJet Toolbox** icon.
 - On the Windows **Start** menu, point to **Programs**, and then click the **HP LaserJet Toolbox**.
 - For Macintosh OS X, on the hard drive, click **Applications**, and then click the **Utilities** folder. Double-click the **HP LaserJet Toolbox** icon.

Note

Once you open the URL, you can bookmark it so that you can return to it quickly in the future.

2. The HP LaserJet Toolbox opens in a Web browser. The HP LaserJet Toolbox software contains the following sections:
 - **Status tab.** View printer status information and supplies status information, and print a configuration page.
 - **Troubleshooting tab.** Contains a control-panel lights simulator, troubleshooting tools, such as the cleaning page and calibration, and maintenance and jam information.
 - **Alerts tab.** Set up the printer to automatically notify you of printer alerts.
 - **Documentation tab.** Contains the *HP Color LaserJet 2550 Series Printer User Guide* and Late-Breaking Readme files.
 - **Device Settings window.** Contains information about printer and supplies status, printer configuration, and network.
 - **HP LaserJet Toolbox links.** View other HP LaserJet Toolbox-enabled devices.
 - **Other links.** Connects to the Internet, if Internet access is available, for product registration and support.

7

Parts and diagrams

Chapter contents

Chapter contents	237
Ordering parts and supplies	238
Parts	238
Related documentation and software	238
Supplies	238
Accessories	239
Assembly locations (1 of 2).....	241
Assembly locations (2 of 2).....	242
Covers.....	244
Internal assemblies.....	246
PCA assemblies.....	268

Ordering parts and supplies

Parts

Order replacement parts from the following Web sites:

h30074.www3.hp.com/csn-aux/srvcdlvry/epdo/default/ePDOLogin.asp (technicians)

h20141.www2.hp.com/hpparts (customers)

Related documentation and software

Order documentation and software from the companies listed in the following table; some documentation and software is available at the following Web sites.

Table 7-1. Technical support Web sites

HP Customer Care Online Software drivers, support documentation, and answers to frequently asked questions	www.hp.com/support
HP Technical Training (North America) Classes and schedules	education.itrc.hp.com/TrainerII/en-US/index.jsp

Supplies

Printer supplies are listed in [Table 3-1. Life expectancies of supplies](#). Consumables are available directly from HP at the following numbers.

- US: 800-538-8787
- Canada: 800-387-3154 (in Toronto: 416-671-8383)
- United Kingdom: 0734-441212
- Germany: 0130-3322

Contact your local HP Parts Coordinator for other local phone numbers.

Accessories

Table 7-2. Accessories

Product name	Description	Product number	Part number	Exchange number
Print cartridges				
Print cartridge	Black print cartridge	Q3960A	Q3960-67901 Q3960-67902 (EMEA)	n/a
Print cartridge	Yellow print cartridge, 2k	Q3972A	Q3972-67901 Q3972-67902 (EMEA)	n/a
Print cartridge	Yellow print cartridge, 4k	Q3962A	Q3962-67901 Q3962-67902 (EMEA)	n/a
Print cartridge	Magenta print cartridge, 2k	Q3973A	Q3973-67901 Q3973-67902 (EMEA)	n/a
Print cartridge	Magenta print cartridge, 4k	Q3963A	Q3963-67901 Q3963-67902 (EMEA)	n/a
Print cartridge	Cyan print cartridge, 2k	Q3971A	Q3971-67901 Q3971-67902 (EMEA)	n/a
Print cartridge	Cyan print cartridge, 4k	Q3961A	Q3961-67901 Q3961-67902 (EMEA)	n/a
Imaging drums				
Imaging drum	Imaging drum	Q3964A	Q3964-67901	n/a
Trays and tray accessories				
Optional 250-sheet tray	1 optional 250-sheet tray	Q3709A	Q3709-67901	n/a
Optional 500-sheet tray	1 optional 500-sheet tray	Q3710A	Q3710-67901	n/a
Tray 1 kit	1 pickup roller and 1 separation pad	C9706-67901	C9706-67901	n/a
Tray 1 kit with extra separation pads	1 pickup roller and 3 separation pads	C9706-67902	C9706-67902	n/a

Table 7-2. Accessories (continued)

Product name	Description	Product number	Part number	Exchange number
Memory				
SDRAM DIMM	128 MB SDRAM DIMM	C9121A	C9121A	n/a
SDRAM DIMM	64 MB SDRAM DIMM	Q1887A	Q1887A	n/a
SDRAM DIMM	32 MB SDRAM DIMM	C7845A	C7845A	n/a
Cables				
Parallel cable	IEEE-1284 cable (a-b), 2-meter	C2950A	C2950A	n/a
Parallel cable	IEEE-1284 cable (a-b), 3-meter	C2951A	C2951A	n/a
USB cable	USB cable (a-b), 2-meter	C6518A	C6518A	n/a
External print servers				
External print server	HP Jetdirect 170x Ethernet, parallel connection	J3258B	J3258B	n/a
External print server	HP Jetdirect 175x Ethernet/Fast Ethernet, USB connection	J6035C	J6035C	n/a
External print server	HP Jetdirect 300x Ethernet/Fast Ethernet, parallel connection	J3263A	J3263A	n/a
External print server	HP Jetdirect 500x Ethernet/Fast Ethernet, parallel connection	J3265A	J3265A	n/a
External print server	HP Jetdirect en3700 Fast Ethernet, Hi-Speed USB 2.0 connection	J7942A	J7942A	n/a
External print server	HP Jetdirect 380 x 802.11b wireless, USB connection	J6061A	J6061A	n/a

Assembly locations (1 of 2)

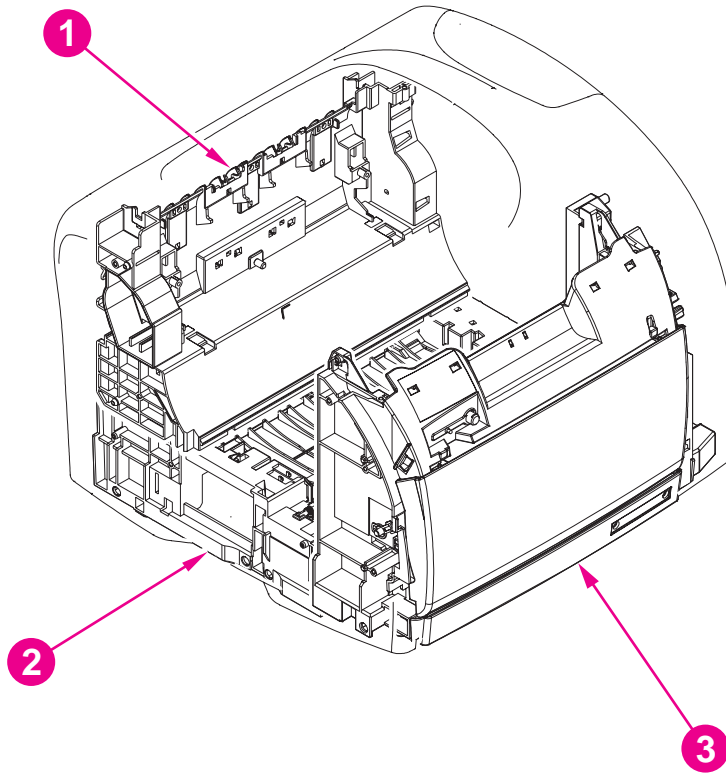

Ref.	Description	Part number
1	Rear frame assembly	See Table 7-3. Covers
2	Middle frame assembly	See Table 7-9. Middle frame assembly
3	Front frame assembly	See Table 7-4. Front frame assembly

Assembly locations (2 of 2)

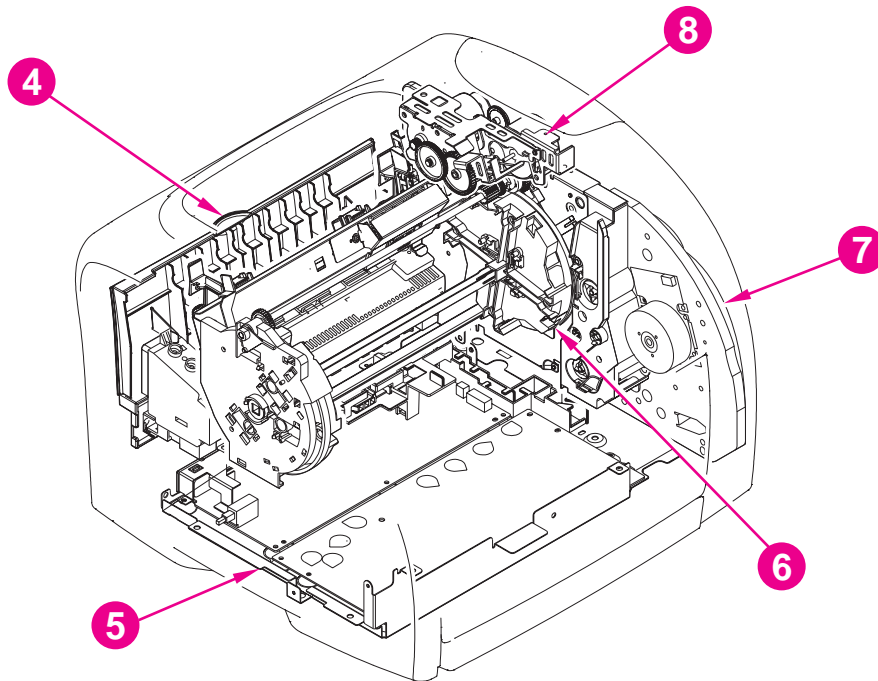

Ref.	Description	Part number
4	Fuser, 110-127 V	RG5-7572-000CN
4	Fuser, 220-240 V	RG4-7573-000CN
5	Power-supply base assembly	See Table 7-11. Power-supply base assembly
6	Rotary assembly	RG5-7587-000CN
7	Main drive assembly	RG5-7579-000CN
8	Rotary drive assembly	RG5-7592-000CN

Covers

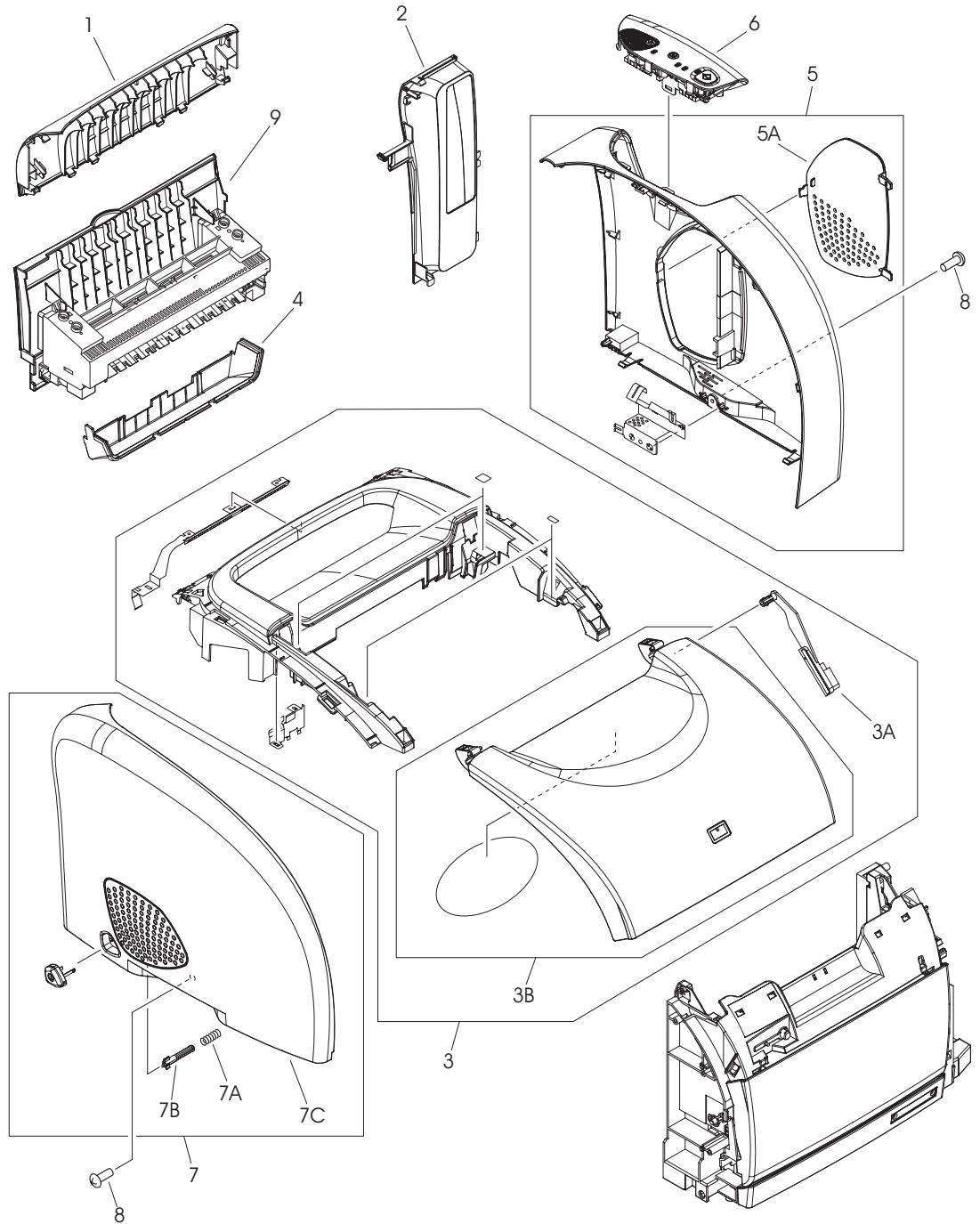

Figure 7-1. Covers

Table 7-3. Covers

Ref	Description	Part number	Qty
1	Cover, rear	RB9-0880-000CN	1
2	Cover, interface	RB3-1112-000CN	1
3	Cover, top (assembly)	RG5-7567-000CN	1
3A	Cover, rack	RB3-0089-000CN	1
3B	Top door	RF5-4069-000CN	1
4	Cover, top output bin	RB9-0881-000CN	1
5	Cover, right side (assembly)	RG5-7569-000CN	1
5A	DIMM door	RB9-0884-000CN	1
6	Control panel assembly	RG5-7570-000CN	1
7	Cover, left side (assembly)	RG5-7571-000CN	1
7A	Spring, on/off switch	RS6-2759-000CN	1
7B	Rod, on/off switch	RB3-0037-000CN	1
7C	Cover, left	RB9-0886-000CN	1
8	Screw, RS, M3x8	XA9-1291-000CN	3
9	Fuser, 110-127 V	RG5-7572-000CN	1
9	Fuser, 220-240 V	RG5-7573-000CN	1

Internal assemblies

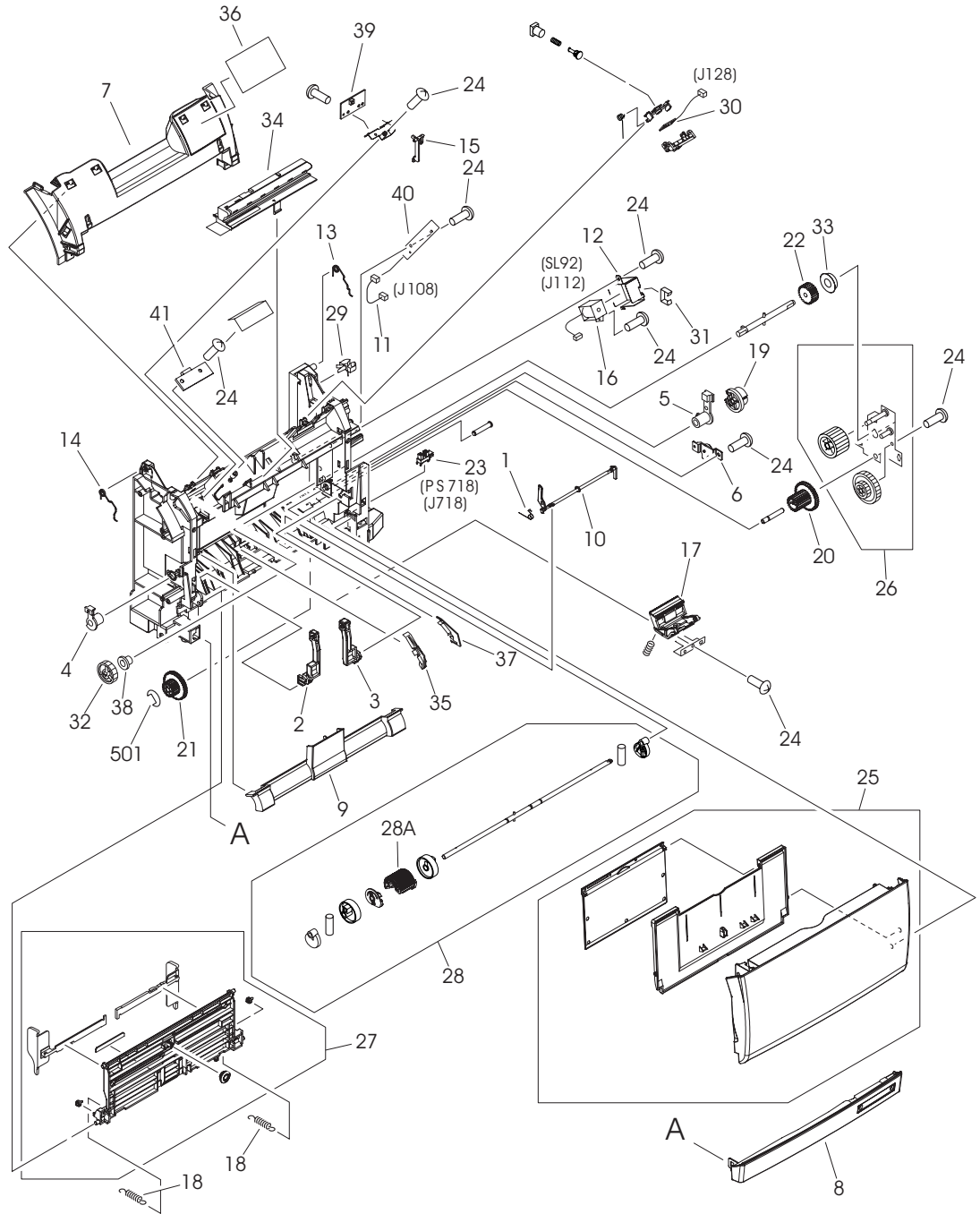

Figure 7-2. Front frame assembly

Table 7-4. Front frame assembly

Ref	Description	Part number	Qty
1	Spring, tray 1 flag	RB2-9952-000CN	1
2	Hinge, left, tray 1	RB9-0889-000CN	1
3	Hinge, right, tray 1	RB9-0890-000CN	1
4	Bushing, left	RB2-3043-000CN	1
5	Bushing, right	RB2-3044-000CN	1
6	Damper	RB2-6248-000CN	1
7	Front cover	RB3-1108-000CN	1
8	Front lower cover	RB9-0897-000CN	1
9	Roller cover	RB3-0104-000CN	1
10	Flag, tray 1 sensor	RB3-0111-000CN	1
11	Cable, waste toner sensor	RG5-7624-000CN	1
12	Cover, solenoid (SL92)	RB3-0120-000CN	1
13	Spring, right	RB3-0121-000CN	1
14	Spring, left	RB3-0122-000CN	1
15	Flag, switch	RB3-0135-000CN	1
16	Solenoid (SL92)	RH7-5338-000CN	1
17	Separation pad assembly	RF5-4012-000CN	1
18	Spring, tray 1 guide	RS6-2030-000CN	2
19	Gear, 26T	RS7-0418-000CN	1
20	Gear, 20T/40T	RS7-0424-000CN	1
21	Gear, 26T/50T	RS7-0426-000CN	1
22	Gear, 26T	RS7-0429-000CN	1
23	Sensor (PS718)	WG8-5382-000CN	1
24	Screw, M4x10	XA9-1262-000CN	11
25	Tray 1 assembly	RG5-7585-000CN	1
26	Gear assembly	RG5-6938-000CN	1
27	Tray 1 guide assembly	RG5-7584-000CN	1
28	Tray 1 pickup assembly	RG5-6952-000CN	1
28A	Pickup roller, tray 1	RB3-0160-000CN	1
29	Clamp, cable	WT2-5700-000CN	2
30	E-label reader PCA	RG5-6956-000CN	1
31	Clip, cable	WT2-5056-000CN	1

Table 7-4. Front frame assembly (continued)

Ref	Description	Part number	Qty
32	Gear, 30T	RS7-0425-000CN	1
33	Bushing, gear assembly	RS5-1635-000CN	1
34	Pad, light-blocking	RF5-4047-000CN	1
35	Guide, left, paper feed	RB2-9954-000CN	1
36	Label, image cartridge	RS6-8662-000CN	1
37	Guide, right, paper feed	RB2-9955-000CN	1
38	Bushing	RS5-1638-000CN	1
39	Sensor, top-of-page	RG5-6966-000CN	1
40	Sensor, waste toner	RG5-7607-000CN	1
41	Sensor, density	RH7-7146-000CN	1
501	E-ring	XD2-1100-502CN	2

Table 7-5. Internal components (1 of 2)

Ref	Description	Part number	Qty
1	Toner-catch tray	RB3-0019-000CN	1
2	RFI shield	RB2-9932-000CN	1
3	Air duct	RB9-0901-000CN	1
4	Gear, 18T	RB3-0091-000CN	1
5	Gear, 15T	RB3-0092-000CN	1
6	Screw, M3x8	XA9-1355-000CN	1
7	Screw, M4x10	XA9-1262-000CN	31
8	Plate, swing shaft, grounding	RB3-1113-000CN	1
9	Fan (FM712)	RH7-1537-000CN	1
10	Clutch (CL1)	RH7-5366-000CN	1
11	Screw, M3x10	XA9-1328-000CN	4
12	Thermistor (TH3)	RH7-7149-000CN	1
13	Cable, upper	RG5-7622-000CN	1
14	Cable, front	RG5-7145-000CN	1
15	Roller assembly, upper, top output bin	RG5-6897-000CN	1
16	Cable, fuser motor	RG5-7620-000CN	1
17	Motor, dc, 24 V	RH7-1613-000CN	1
18	Gear, 32T/37T	RS7-0435-000CN	1
19	Gear, 37T/43T	RS7-0436-000CN	1
20	Gear, 51T	RS7-0437-000CN	1
21	Spring, torsion	RB2-9905-000CN	2
22	Roller, small, top output bin	RF5-4068-000CN	1
23	Label, caution	RS6-8668-000CN	1
24	Screw, RS, M3x6	XA9-0849-000CN	5
25	Main drive assembly	RG5-7579-000CN	1
501	E-ring	XD2-1100-322CN	1

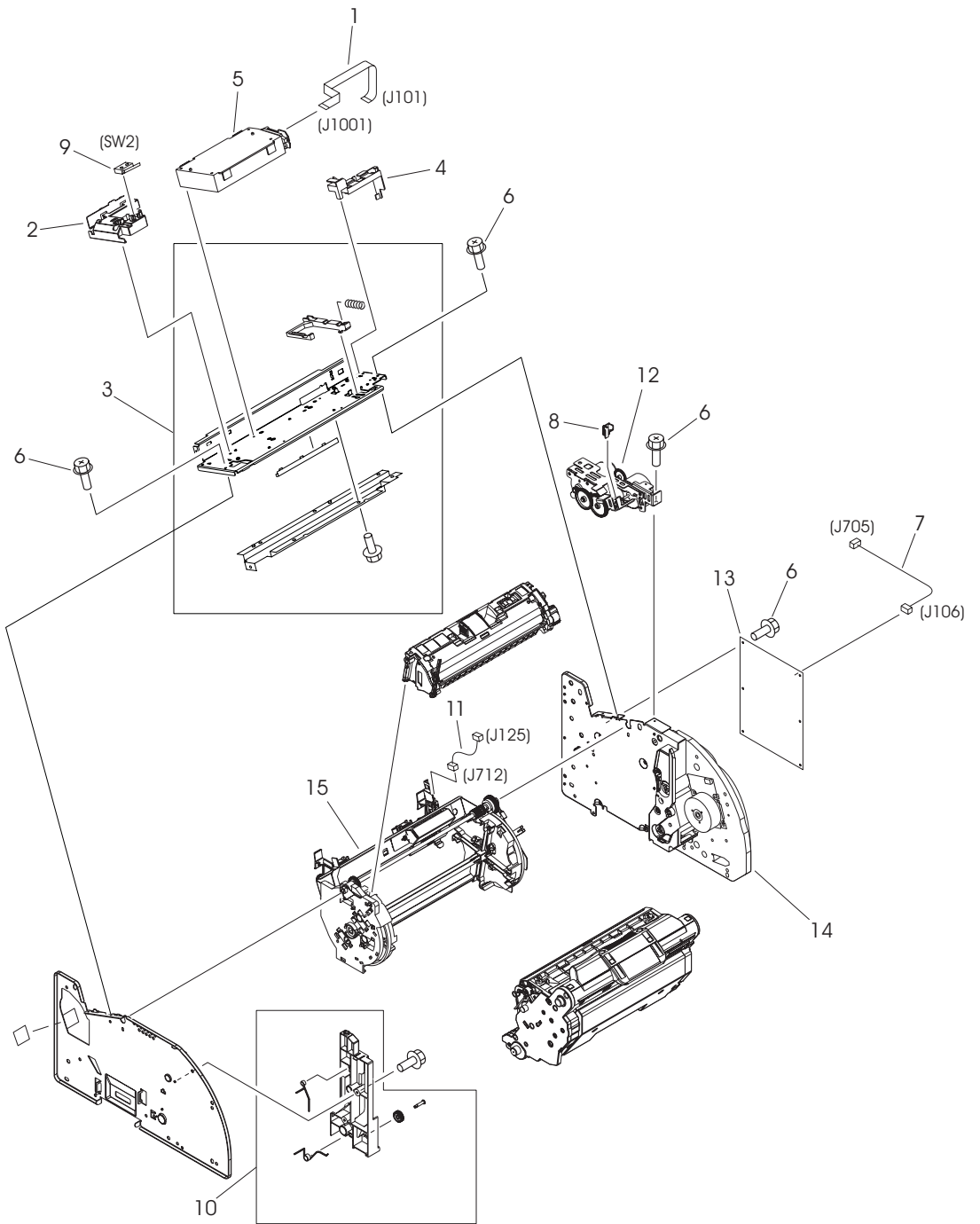

Figure 7-4. Internal components (2 of 2)

Table 7-6. Internal components (2 of 2)

Ref	Description	Part number	Qty
1	Cable, flat, flexible, laser/scanner	RH2-5524-000CN	1
2	Holder, interlock switch	RB3-0023-000CN	1
3	Top plate	RG5-6907-000CN	1
4	Cable guide	RB2-9903-000CN	1
5	Laser/scanner	RG5-6880-000CN	1
6	Screw, M3x6	XA9-0849-000CN	18
7	Cable, motor	RG5-7114-000CN	1
8	Guide, rotary release	RB2-9852-000CN	1
9	Switch, interlock	RH7-6051-000CN	1
10	Cartridge guide assembly	RG5-6935-000CN	1
11	Cable, sensor	RG5-7117-000CN	1
12	Rotary drive assembly	RG5-7592-000CN	1
13	Dc Controller	RG5-7605-000CN	1
14	Main drive assembly	RG5-7579-000CN	1
15	Rotary assembly	RG5-7587-000CN	1

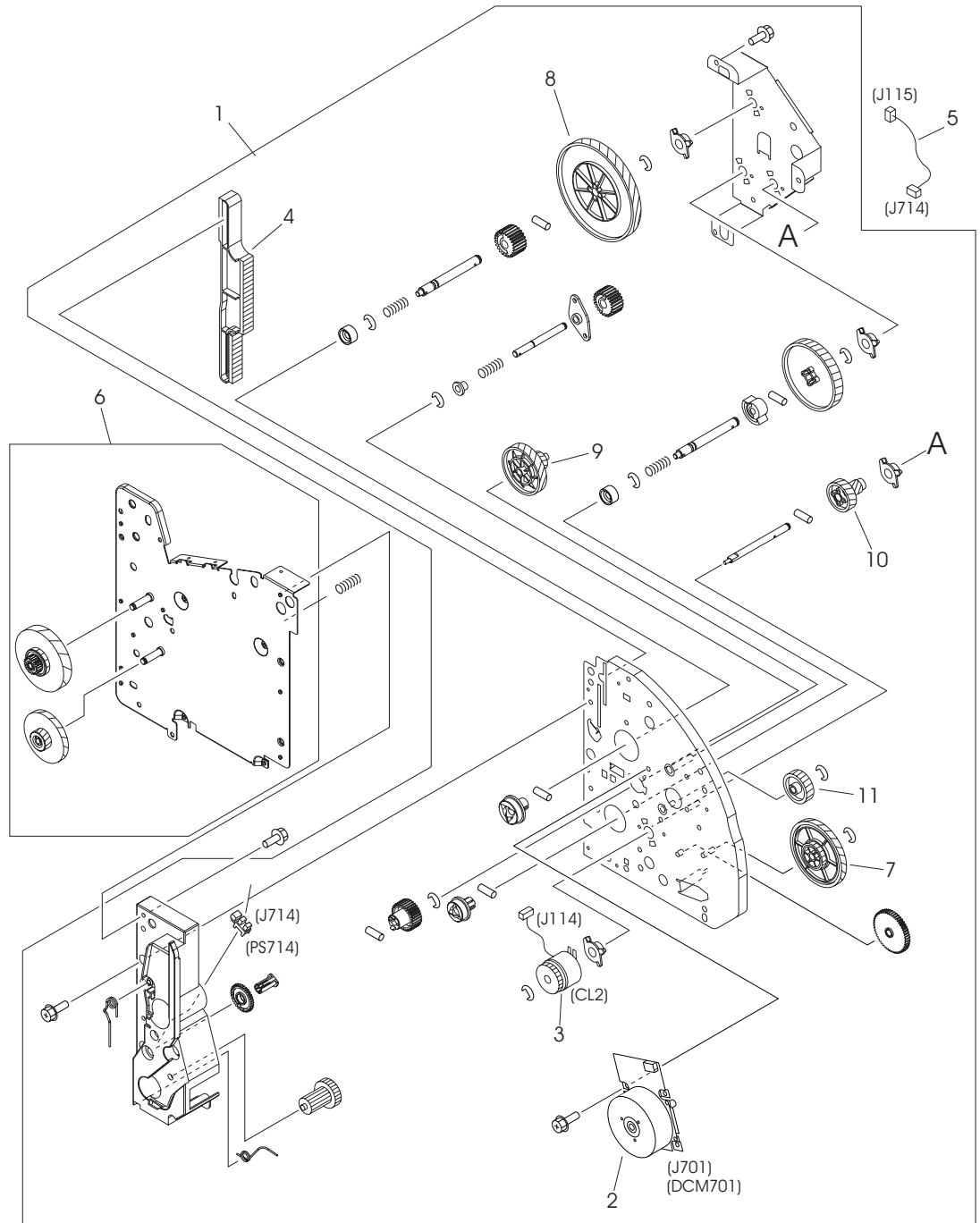

Figure 7-5. Main drive assembly

Table 7-7. Main drive assembly

Ref	Description	Part number	Qty
	Main drive assembly	RG5-7579-000CN	1
1	Right side plate front assembly	RG5-7581-000CN	1
2	Gear train motor	RF5-4063-000CN	1
3	Clutch, main gear train (CL2)	RH7-5335-000CN	1
4	Rack	RB3-0090-000CN	1
5	Cable, transfer sensor (2nd)	RG5-7115-000CN	1
6	Right side plate rear assembly	RG5-7580-000CN	1
7	Gear, 32T/123T	RS7-0574-000CN	1
8	Gear, 186T	RS7-0573-000CN	1
9	Gear, 31T/90T	RS7-0572-000CN	1
10	Gear, 23T/54T	RS7-0571-000CN	1
11	Gear, 81T	RS7-0570-000CN	1

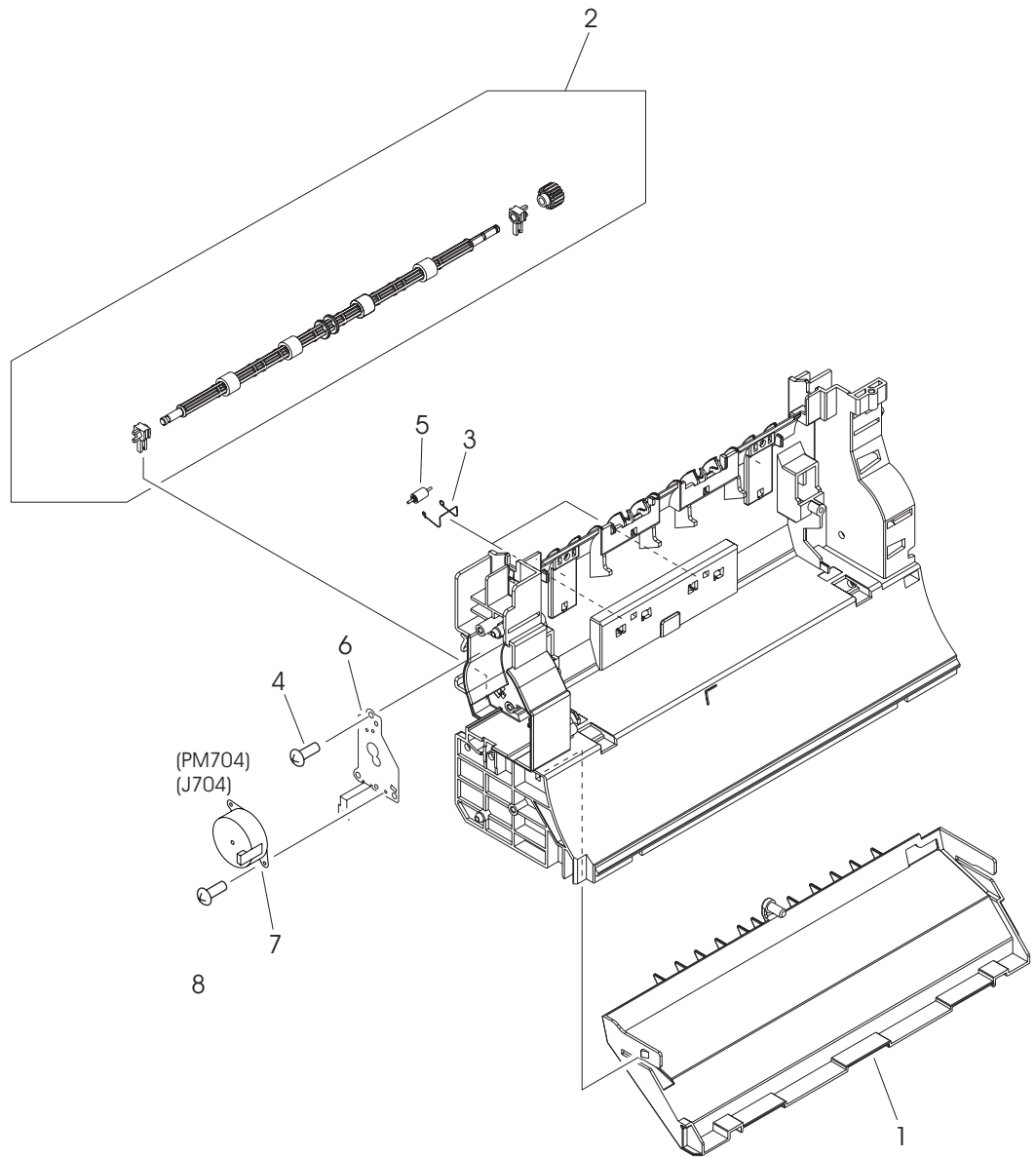

Figure 7-6. Rear frame assembly

Table 7-8. Rear frame assembly

Ref	Description	Part number	Qty
1	Fuser duct	RB2-9904-000CN	1
2	Roller, lower, top output bin	RG5-7595-000CN	1
3	Spring, left	RB3-1065-000CN	2
4	Screw, M4x10	XA9-1262-000CN	3
5	Roller, lower, top output bin, small	RB2-9909-000CN	2
6	Cover, fuser motor	RB2-9916-000CN	1
7	Motor, dc, 24 V	RH7-1533-000CN	1
8	Screw, RS, M3x6	XA9-0849-000CN	2

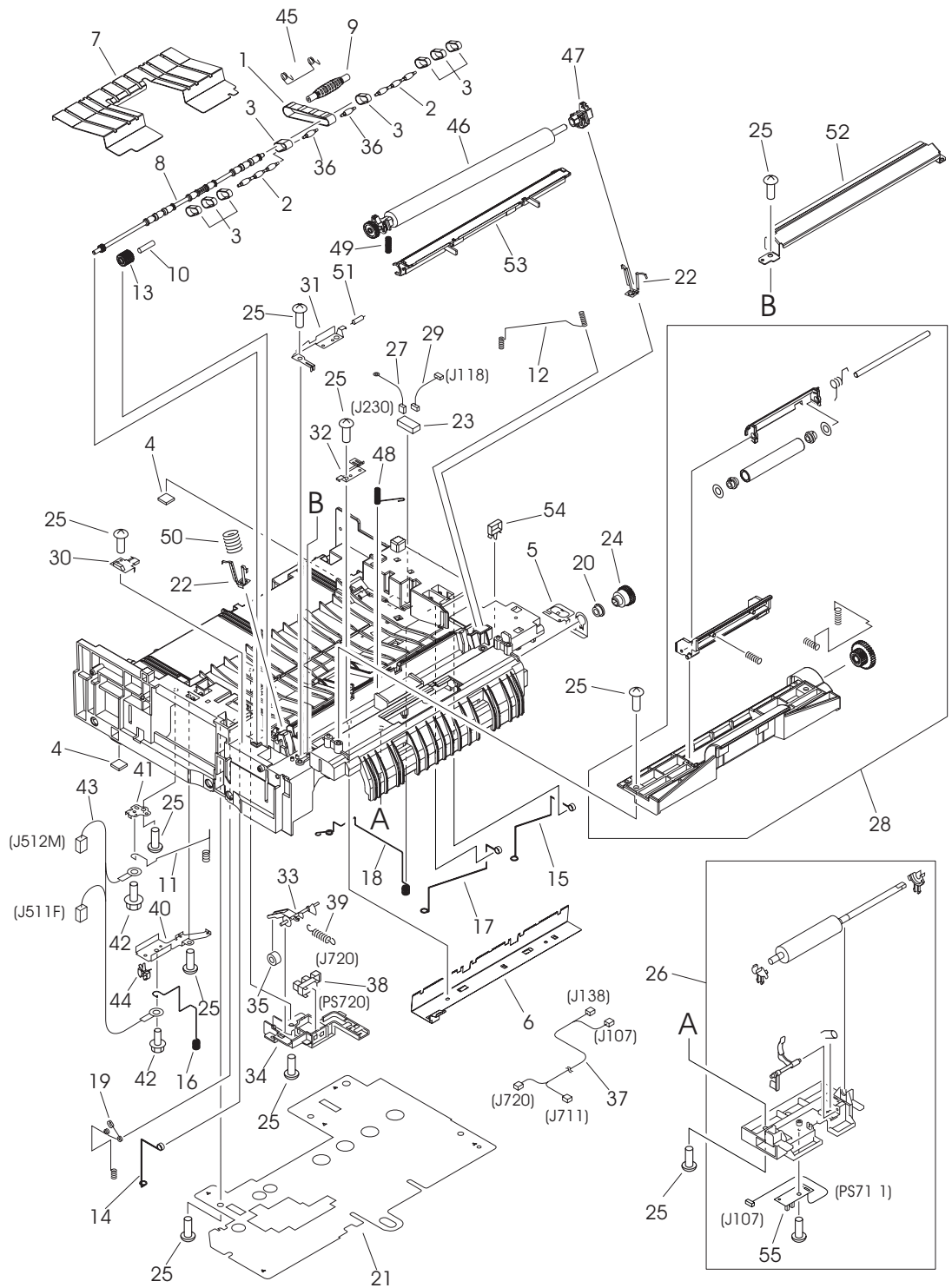

Figure 7-7. Middle frame assembly

Table 7-9. Middle frame assembly

Ref	Description	Part number	Qty
1	Timing belt	RB1-8668-030CN	1
2	Pulley	RB3-0061-000CN	2
3	Feed belt	RB3-0063-000CN	8
4	Rubber foot	RB2-6297-000CN	2
5	Grounding plate	RB3-0286-000CN	1
6	Static charge eliminator plate	RB3-0009-000CN	1
7	Feed plate	RB3-0010-000CN	1
8	Shaft, feed drive	RB3-0011-000CN	1
9	Roller, belt	RB3-0012-000CN	1
10	Shaft, idler gear	RB3-0060-000CN	1
11	Spring	RB3-0045-000CN	1
12	Spring	RB3-0016-000CN	1
13	Gear, idler, 23T	RB3-0022-000CN	1
14	Spring	RB3-0042-000CN	1
15	Spring	RB3-0043-000CN	1
16	Spring	RB3-0044-000CN	1
17	Spring	RB3-0046-000CN	1
18	Spring	RB3-0047-000CN	1
19	Spring	RB3-0048-000CN	1
20	Bushing	RS5-1637-000CN	1
21	Insulating sheet	RB3-1110-000CN	1
22	Transfer slide plate	RB3-0057-000CN	2
23	Connector, optional trays	RH2-5519-000CN	1
24	Gear, 30T	RS7-0428-000CN	1
25	Screw, M4x10	XA9-1262-000CN	13
26	Registration roller assembly	RG5-6939-000CN	1
27	Cable, grounding	RG5-7123-000CN	1
28	Registration shutter assembly	RG5-6940-000CN	1
29	Cable, interface	RG5-7122-000CN	1
30	Cover, gear	RB3-0052-000CN	1
31	Grounding spring	RB3-0065-000CN	1
32	Grounding spring	RB3-0066-000CN	1

Table 7-9. Middle frame assembly (continued)

Ref	Description	Part number	Qty
33	Flag, transfer sensor	RB2-9925-000CN	1
34	Holder, transfer sensor	RB2-9924-000CN	1
35	Roller, transfer sensor	RB2-7195-000CN	1
36	Pulley	RB3-0067-000CN	2
37	Cable	RG5-7128-000CN	1
38	Sensor, transfer (PS720)	WG8-5382-000CN	1
39	Spring	RS6-2766-000CN	1
40	Mount, terminal	RB2-9850-000CN	1
41	Mount, antenna contact	RB2-9851-000CN	1
42	Screw, RS, M3x6	XA9-0890-000CN	2
43	Cable, high-voltage transformer	RG5-7130-000CN	1
44	Clamp, cable	WT2-5700-000CN	1
45	Spring	RB2-9999-000CN	1
46	Roller, transfer	RF5-4067-000CN	1
47	Bushing	RB3-1094-000CN	1
48	Spring	RB3-1091-000CN	1
49	Spring	RB3-1092-000CN	1
50	Spring	RB3-0015-000CN	1
51	Resistor	RH5-3115-000CN	1
52	Guide, transfer inlet	RB3-1088-000CN	1
53	Entrance guide	RF5-4065-000CN	1
54	Clip, cable	WT2-5737-000CN	1
55	Registration sensor	RG5-6967-000CN	1

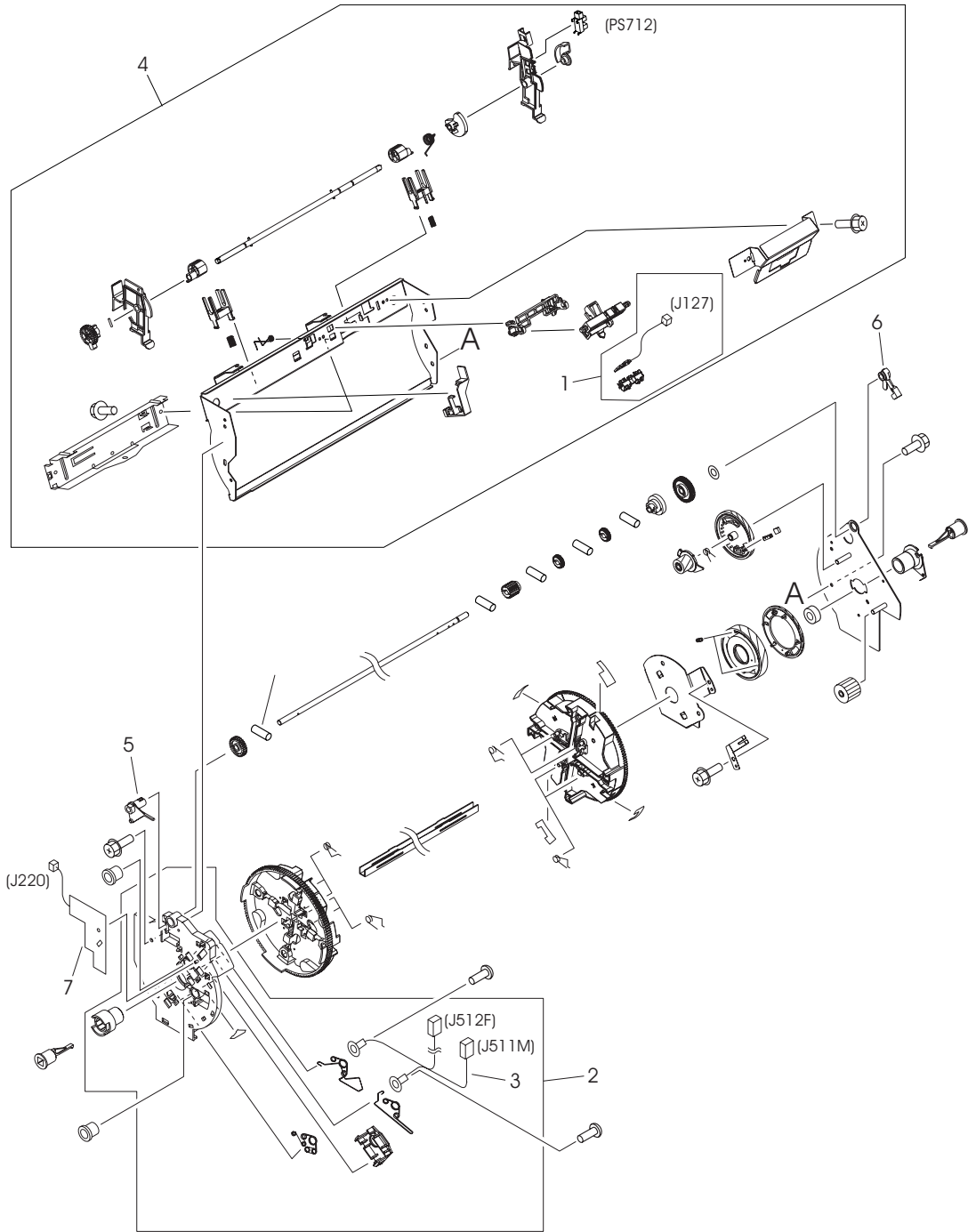

Figure 7-8. Rotary (carousel) assembly

Table 7-10. Rotary assembly

Ref	Description	Part number	Qty
	Rotary (carousel) assembly	RG5-7587-000CN	1
1	Contact assembly, E-label reader	RG5-6957-000CN	1
2	Rotary plate assembly, left	RG5-6942-000CN	1
3	Cable, rotary assembly	RG5-7129-000CN	1
4	Rotary pressure assembly	RG5-7589-000CN	1
5	Carousel lock, left (white)	RB2-9809-000CN	1
6	Carousel lock, right (black)	RB9-0879-000CN	1
7	Toner-sensor PCA	RG5-6964-000CN	1

Table 7-11. Power-supply base assembly

Ref	Description	Part number	Qty
1	Holder, fuser connector	RB3-0006-000CN	1
2	Insulating sheet	RB3-0007-000CN	1
3	Support, high-voltage PCA	VT2-0012-005CN	6
4	Cable, high-voltage transformer	RG5-7146-000CN	1
5	Clip, cable	WT2-5737-000CN	2
6	Screw, M3x8	XA9-1355-000CN	9
7	Cable, sub-high-voltage transformer	RG5-7126-000CN	1
8	Cable, fuser connector, dc controller	RG5-7109-000CN	1
9	Cable, fuser, power	RG5-6971-000CN	1
10	Cable, formatter, power	RG5-7106-000CN	1
11	Cable, power (1)	RG5-7621-000CN	1
12	Cable, power (2)	RG5-7108-000CN	1
13	Holder, high-voltage	RB3-0062-000CN	1
14	Screw, M3x8	XA9-1291-000CN	4
15	Low-voltage PCA, 110-127 V	RH3-2254-000CN	1
15	Low-voltage PCA, 220-240 V	RH3-2255-000CN	1
16	High-voltage transformer PCA	RG5-7606-000CN	1
17	Sub-high-voltage transformer PCA	RG5-7124-000CN	1

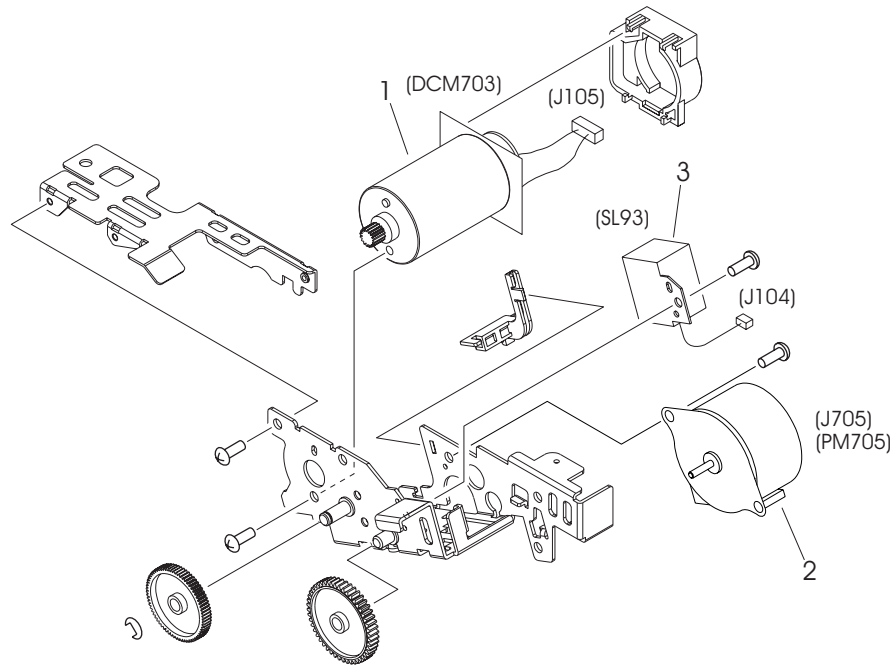

Figure 7-10. Rotary-drive assembly

Table 7-12. Rotary-drive assembly

Ref	Description	Part number	Qty
	Rotary drive assembly	RG5-7592-000CN	1
1	Motor (DCM703)	RG5-7593-000CN	1
2	Motor (PM705)	RH7-1535-000CN	1
3	Solenoid (SL93)	RH7-5340-000CN	1

PCA assemblies

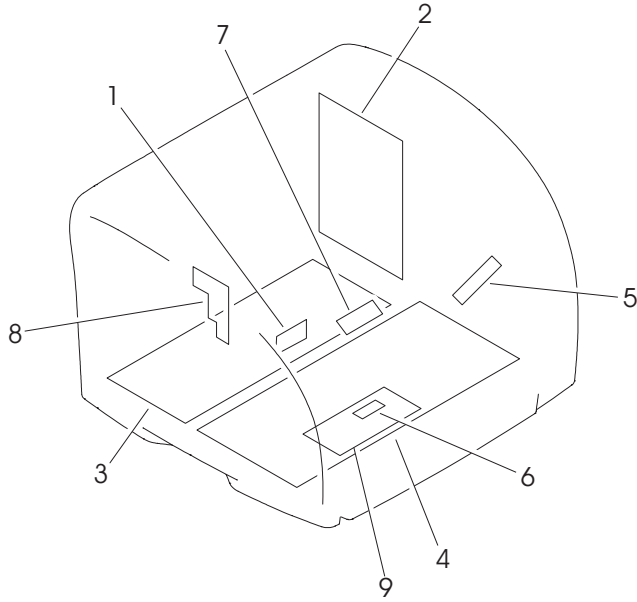

Figure 7-11. PCA assemblies

Table 7-13. PCA assemblies

Ref	Description	Part number	Qty
1	Top-of-page sensor PCA	RG5-6966-000CN	1
2	Dc controller	RG5-7605-000CN	1
3	Low-voltage PCA, 110-127 V	RH3-2254-000CN	1
3	Low-voltage PCA, 220-240 V	RH3-2255-000CN	1
4	High-voltage transformer PCA	RG5-7606-000CN	1
5	Waste-toner sensor PCA	RG5-7607-000CN	1
6	Registration-sensor PCA	RG5-6967-000CN	1
7	Density-sensor PCA	RH7-7146-000CN	1
8	Toner-sensor PCA	RG5-6964-000CN	1
9	Sub-high-voltage transformer PCA	RG5-7124-000CN	1
	Formatter, HP color LaserJet 2550L printer	Q3702-67901	
	Formatter (includes network card), HP color LaserJet 2550Ln printer and HP color LaserJet 2550n printer	Q3703-67901	

Alphabetical parts list

Table 7-14. Alphabetical parts list

Description	Part number	Table and page
Air duct	RB9-0901-000CN	Table 7-5 on page 251
Bushing	RS5-1638-000CN	Table 7-4 on page 248
Bushing	RS5-1637-000CN	Table 7-9 on page 259
Bushing	RB3-1094-000CN	Table 7-9 on page 260
Bushing, gear assembly	RS5-1635-000CN	Table 7-4 on page 248
Bushing, left	RB2-3043-000CN	Table 7-4 on page 247
Bushing, right	RB2-3044-000CN	Table 7-4 on page 247
Cable	RG5-7128-000CN	Table 7-9 on page 260
Cable guide	RB2-9903-000CN	Table 7-6 on page 253
Cable, flat, flexible, laser/scanner	RH2-5524-000CN	Table 7-6 on page 253
Cable, formatter, power	RG5-7106-000CN	Table 7-11 on page 265
Cable, front	RG5-7145-000CN	Table 7-5 on page 251
Cable, fuser connector, dc controller	RG5-7109-000CN	Table 7-11 on page 265
Cable, fuser motor	RG5-7620-000CN	Table 7-5 on page 251
Cable, fuser, power	RG5-6971-000CN	Table 7-11 on page 265
Cable, grounding	RG5-7123-000CN	Table 7-9 on page 259
Cable, high-voltage transformer	RG5-7130-000CN	Table 7-9 on page 260
Cable, high-voltage transformer	RG5-7146-000CN	Table 7-11 on page 265
Cable, interface	RG5-7122-000CN	Table 7-9 on page 259
Cable, motor	RG5-7114-000CN	Table 7-6 on page 253
Cable, power (1)	RG5-7621-000CN	Table 7-11 on page 265
Cable, power (2)	RG5-7108-000CN	Table 7-11 on page 265
Cable, rotary assembly	RG5-7129-000CN	Table 7-10 on page 263
Cable, sensor	RG5-7117-000CN	Table 7-6 on page 253
Cable, sub-high-voltage transformer	RG5-7126-000CN	Table 7-11 on page 265

Table 7-14. Alphabetical parts list (continued)

Description	Part number	Table and page
Cable, transfer sensor (2nd)	RG5-7115-000CN	Table 7-7 on page 255
Cable, upper	RG5-7622-000CN	Table 7-5 on page 251
Cable, waste toner sensor	RG5-7624-000CN	Table 7-4 on page 247
Carousel lock, left (white)	RB2-9809-000CN	Table 7-10 on page 263
Carousel lock, right (black)	RB9-0879-000CN	Table 7-10 on page 263
Cartridge guide assembly	RG5-6935-000CN	Table 7-6 on page 253
Clamp, cable	WT2-5700-000CN	Table 7-4 on page 247
Clamp, cable	WT2-5700-000CN	Table 7-9 on page 260
Clip, cable	WT2-5056-000CN	Table 7-4 on page 247
Clip, cable	WT2-5737-000CN	Table 7-9 on page 260
Clip, cable	WT2-5737-000CN	Table 7-11 on page 265
Clutch (CL1)	RH7-5366-000CN	Table 7-5 on page 251
Clutch, main gear train (CL2)	RH7-5335-000CN	Table 7-7 on page 255
Connector, optional trays	RH2-5519-000CN	Table 7-9 on page 259
Contact assembly, E-label reader	RG5-6957-000CN	Table 7-10 on page 263
Control panel assembly	RG5-7570-000CN	Table 7-3 on page 245
Cover, fuser motor	RB2-9916-000CN	Table 7-8 on page 257
Cover, gear	RB3-0052-000CN	Table 7-9 on page 259
Cover, interface	RB3-1112-000CN	Table 7-3 on page 245
Cover, left	RB9-0886-000CN	Table 7-3 on page 245
Cover, left side (assembly)	RG5-7571-000CN	Table 7-3 on page 245
Cover, rack	RB3-0089-000CN	Table 7-3 on page 245
Cover, rear	RB9-0880-000CN	Table 7-3 on page 245
Cover, right side (assembly)	RG5-7569-000CN	Table 7-3 on page 245
Cover, solenoid (SL92)	RB3-0120-000CN	Table 7-4 on page 247
Cover, top (assembly)	RG5-7567-000CN	Table 7-3 on page 245
Cover, top output bin	RB9-0881-000CN	Table 7-3 on page 245
Damper	RB2-6248-000CN	Table 7-4 on page 247
Dc Controller	RG5-7605-000CN	Table 7-6 on page 253
Dc controller	RG5-7605-000CN	Table 7-13 on page 269

Table 7-14. Alphabetical parts list (continued)

Description	Part number	Table and page
Density-sensor PCA	RH7-7146-000CN	Table 7-13 on page 269
DIMM door	RB9-0884-000CN	Table 7-3 on page 245
E-label reader PCA	RG5-6956-000CN	Table 7-4 on page 247
E-ring	XD2-1100-502CN	Table 7-4 on page 248
E-ring	XD2-1100-322CN	Table 7-5 on page 251
Entrance guide	RF5-4065-000CN	Table 7-9 on page 260
Fan (FM712)	RH7-1537-000CN	Table 7-5 on page 251
Feed belt	RB3-0063-000CN	Table 7-9 on page 259
Feed plate	RB3-0010-000CN	Table 7-9 on page 259
Flag, switch	RB3-0135-000CN	Table 7-4 on page 247
Flag, transfer sensor	RB2-9925-000CN	Table 7-9 on page 260
Flag, tray 1 sensor	RB3-0111-000CN	Table 7-4 on page 247
Formatter (includes network card), HP color LaserJet 2550Ln printer and HP color LaserJet 2550n printer	Q3703-67901	Table 7-13 on page 269
Formatter, HP color LaserJet 2550L printer	Q3702-67901	Table 7-13 on page 269
Front cover	RB3-1108-000CN	Table 7-4 on page 247
Front lower cover	RB9-0897-000CN	Table 7-4 on page 247
Fuser duct	RB2-9904-000CN	Table 7-8 on page 257
Fuser, 110-127 V	RG5-7572-000CN	Table 7-3 on page 245
Fuser, 220-240 V	RG5-7573-000CN	Table 7-3 on page 245
Gear assembly	RG5-6938-000CN	Table 7-4 on page 247
Gear train motor	RF5-4063-000CN	Table 7-7 on page 255
Gear, 15T	RB3-0092-000CN	Table 7-5 on page 251
Gear, 186T	RS7-0573-000CN	Table 7-7 on page 255
Gear, 18T	RB3-0091-000CN	Table 7-5 on page 251
Gear, 20T/40T	RS7-0424-000CN	Table 7-4 on page 247
Gear, 23T/54T	RS7-0571-000CN	Table 7-7 on page 255
Gear, 26T	RS7-0418-000CN	Table 7-4 on page 247
Gear, 26T	RS7-0429-000CN	Table 7-4 on page 247
Gear, 26T/50T	RS7-0426-000CN	Table 7-4 on page 247
Gear, 30T	RS7-0425-000CN	Table 7-4 on page 248

Table 7-14. Alphabetical parts list (continued)

Description	Part number	Table and page
Gear, 30T	RS7-0428-000CN	Table 7-9 on page 259
Gear, 31T/90T	RS7-0572-000CN	Table 7-7 on page 255
Gear, 32T/123T	RS7-0574-000CN	Table 7-7 on page 255
Gear, 32T/37T	RS7-0435-000CN	Table 7-5 on page 251
Gear, 37T/43T	RS7-0436-000CN	Table 7-5 on page 251
Gear, 51T	RS7-0437-000CN	Table 7-5 on page 251
Gear, 81T	RS7-0570-000CN	Table 7-7 on page 255
Gear, idler, 23T	RB3-0022-000CN	Table 7-9 on page 259
Grounding plate	RB3-0286-000CN	Table 7-9 on page 259
Grounding spring	RB3-0065-000CN	Table 7-9 on page 259
Grounding spring	RB3-0066-000CN	Table 7-9 on page 259
Guide, left, paper feed	RB2-9954-000CN	Table 7-4 on page 248
Guide, right, paper feed	RB2-9955-000CN	Table 7-4 on page 248
Guide, rotary release	RB2-9852-000CN	Table 7-6 on page 253
Guide, transfer inlet	RB3-1088-000CN	Table 7-9 on page 260
High-voltage transformer PCA	RG5-7606-000CN	Table 7-11 on page 265
High-voltage transformer PCA	RG5-7606-000CN	Table 7-13 on page 269
Hinge, left, tray 1	RB9-0889-000CN	Table 7-4 on page 247
Hinge, right, tray 1	RB9-0890-000CN	Table 7-4 on page 247
Holder, fuser connector	RB3-0006-000CN	Table 7-11 on page 265
Holder, high-voltage	RB3-0062-000CN	Table 7-11 on page 265
Holder, interlock switch	RB3-0023-000CN	Table 7-6 on page 253
Holder, transfer sensor	RB2-9924-000CN	Table 7-9 on page 260
Insulating sheet	RB3-1110-000CN	Table 7-9 on page 259
Insulating sheet	RB3-0007-000CN	Table 7-11 on page 265
Label, caution	RS6-8668-000CN	Table 7-5 on page 251
Label, image cartridge	RS6-8662-000CN	Table 7-4 on page 248
Laser/scanner	RG5-6880-000CN	Table 7-6 on page 253
Low-voltage PCA, 110-127 V	RH3-2254-000CN	Table 7-11 on page 265

Table 7-14. Alphabetical parts list (continued)

Description	Part number	Table and page
Low-voltage PCA, 110-127 V	RH3-2254-000CN	Table 7-13 on page 269
Low-voltage PCA, 220-240 V	RH3-2255-000CN	Table 7-11 on page 265
Low-voltage PCA, 220-240 V	RH3-2255-000CN	Table 7-13 on page 269
Main drive assembly	RG5-7579-000CN	Table 7-5 on page 251
Main drive assembly	RG5-7579-000CN	Table 7-6 on page 253
Main drive assembly	RG5-7579-000CN	Table 7-7 on page 255
Motor (DCM703)	RG5-7593-000CN	Table 7-12 on page 267
Motor (PM705)	RH7-1535-000CN	Table 7-12 on page 267
Motor, dc, 24 V	RH7-1613-000CN	Table 7-5 on page 251
Motor, dc, 24 V	RH7-1533-000CN	Table 7-8 on page 257
Mount, antenna contact	RB2-9851-000CN	Table 7-9 on page 260
Mount, terminal	RB2-9850-000CN	Table 7-9 on page 260
Pad, light-blocking	RF5-4047-000CN	Table 7-4 on page 248
Pickup roller, tray 1	RB3-0160-000CN	Table 7-4 on page 247
Plate, swing shaft, grounding	RB3-1113-000CN	Table 7-5 on page 251
Pulley	RB3-0061-000CN	Table 7-9 on page 259
Pulley	RB3-0067-000CN	Table 7-9 on page 260
Rack	RB3-0090-000CN	Table 7-7 on page 255
Registration roller assembly	RG5-6939-000CN	Table 7-9 on page 259
Registration sensor	RG5-6967-000CN	Table 7-9 on page 260
Registration shutter assembly	RG5-6940-000CN	Table 7-9 on page 259
Registration-sensor PCA	RG5-6967-000CN	Table 7-13 on page 269
Resistor	RH5-3115-000CN	Table 7-9 on page 260
RFI shield	RB2-9932-000CN	Table 7-5 on page 251
Right side plate front assembly	RG5-7581-000CN	Table 7-7 on page 255
Right side plate rear assembly	RG5-7580-000CN	Table 7-7 on page 255
Rod, on/off switch	RB3-0037-000CN	Table 7-3 on page 245
Roller assembly, upper, top output bin	RG5-6897-000CN	Table 7-5 on page 251
Roller cover	RB3-0104-000CN	Table 7-4 on page 247

Table 7-14. Alphabetical parts list (continued)

Description	Part number	Table and page
Roller, belt	RB3-0012-000CN	Table 7-9 on page 259
Roller, lower, top output bin	RG5-7595-000CN	Table 7-8 on page 257
Roller, lower, top output bin, small	RB2-9909-000CN	Table 7-8 on page 257
Roller, small, top output bin	RF5-4068-000CN	Table 7-5 on page 251
Roller, transfer	RF5-4067-000CN	Table 7-9 on page 260
Roller, transfer sensor	RB2-7195-000CN	Table 7-9 on page 260
Rotary (carousel) assembly	RG5-7587-000CN	Table 7-10 on page 263
Rotary assembly	RG5-7587-000CN	Table 7-6 on page 253
Rotary drive assembly	RG5-7592-000CN	Table 7-6 on page 253
Rotary drive assembly	RG5-7592-000CN	Table 7-12 on page 267
Rotary plate assembly, left	RG5-6942-000CN	Table 7-10 on page 263
Rotary pressure assembly	RG5-7589-000CN	Table 7-10 on page 263
Rubber foot	RB2-6297-000CN	Table 7-9 on page 259
Screw, M3x10	XA9-1328-000CN	Table 7-5 on page 251
Screw, M3x6	XA9-0849-000CN	Table 7-6 on page 253
Screw, M3x8	XA9-1355-000CN	Table 7-5 on page 251
Screw, M3x8	XA9-1355-000CN	Table 7-11 on page 265
Screw, M3x8	XA9-1291-000CN	Table 7-11 on page 265
Screw, M4x10	XA9-1262-000CN	Table 7-4 on page 247
Screw, M4x10	XA9-1262-000CN	Table 7-5 on page 251
Screw, M4x10	XA9-1262-000CN	Table 7-8 on page 257
Screw, M4x10	XA9-1262-000CN	Table 7-9 on page 259
Screw, RS, M3x6	XA9-0849-000CN	Table 7-5 on page 251
Screw, RS, M3x6	XA9-0849-000CN	Table 7-8 on page 257
Screw, RS, M3x6	XA9-0890-000CN	Table 7-9 on page 260
Screw, RS, M3x8	XA9-1291-000CN	Table 7-3 on page 245
Sensor (PS718)	WG8-5382-000CN	Table 7-4 on page 247
Sensor, density	RH7-7146-000CN	Table 7-4 on page 248
Sensor, top-of-page	RG5-6966-000CN	Table 7-4 on page 248

Table 7-14. Alphabetical parts list (continued)

Description	Part number	Table and page
Sensor, transfer (PS720)	WG8-5382-000CN	Table 7-9 on page 260
Sensor, waste toner	RG5-7607-000CN	Table 7-4 on page 248
Separation pad assembly	RF5-4012-000CN	Table 7-4 on page 247
Shaft, feed drive	RB3-0011-000CN	Table 7-9 on page 259
Shaft, idler gear	RB3-0060-000CN	Table 7-9 on page 259
Solenoid (SL92)	RH7-5338-000CN	Table 7-4 on page 247
Solenoid (SL93)	RH7-5340-000CN	Table 7-12 on page 267
Spring	RB3-0045-000CN	Table 7-9 on page 259
Spring	RB3-0016-000CN	Table 7-9 on page 259
Spring	RB3-0042-000CN	Table 7-9 on page 259
Spring	RB3-0043-000CN	Table 7-9 on page 259
Spring	RB3-0044-000CN	Table 7-9 on page 259
Spring	RB3-0046-000CN	Table 7-9 on page 259
Spring	RB3-0047-000CN	Table 7-9 on page 259
Spring	RB3-0048-000CN	Table 7-9 on page 259
Spring	RS6-2766-000CN	Table 7-9 on page 260
Spring	RB2-9999-000CN	Table 7-9 on page 260
Spring	RB3-1091-000CN	Table 7-9 on page 260
Spring	RB3-1092-000CN	Table 7-9 on page 260
Spring	RB3-0015-000CN	Table 7-9 on page 260
Spring, left	RB3-0122-000CN	Table 7-4 on page 247
Spring, left	RB3-1065-000CN	Table 7-8 on page 257
Spring, on/off switch	RS6-2759-000CN	Table 7-3 on page 245
Spring, right	RB3-0121-000CN	Table 7-4 on page 247
Spring, torsion	RB2-9905-000CN	Table 7-5 on page 251
Spring, tray 1 flag	RB2-9952-000CN	Table 7-4 on page 247
Spring, tray 1 guide	RS6-2030-000CN	Table 7-4 on page 247
Static charge eliminator plate	RB3-0009-000CN	Table 7-9 on page 259
Sub-high-voltage transformer PCA	RG5-7124-000CN	Table 7-11 on page 265
Sub-high-voltage transformer PCA	RG5-7124-000CN	Table 7-13 on page 269

Table 7-14. Alphabetical parts list (continued)

Description	Part number	Table and page
Support, high-voltage PCA	VT2-0012-005CN	Table 7-11 on page 265
Switch, interlock	RH7-6051-000CN	Table 7-6 on page 253
Thermistor (TH3)	RH7-7149-000CN	Table 7-5 on page 251
Timing belt	RB1-8668-030CN	Table 7-9 on page 259
Toner-catch tray	RB3-0019-000CN	Table 7-5 on page 251
Toner-sensor PCA	RG5-6964-000CN	Table 7-10 on page 263
Toner-sensor PCA	RG5-6964-000CN	Table 7-13 on page 269
Top door	RF5-4069-000CN	Table 7-3 on page 245
Top plate	RG5-6907-000CN	Table 7-6 on page 253
Top-of-page sensor PCA	RG5-6966-000CN	Table 7-13 on page 269
Transfer slide plate	RB3-0057-000CN	Table 7-9 on page 259
Tray 1 assembly	RG5-7585-000CN	Table 7-4 on page 247
Tray 1 guide assembly	RG5-7584-000CN	Table 7-4 on page 247
Tray 1 pickup assembly	RG5-6952-000CN	Table 7-4 on page 247
Waste-toner sensor PCA	RG5-7607-000CN	Table 7-13 on page 269

Numerical parts list

Table 7-15. Numerical parts list

Part number	Description	Table and page
Q3702-67901	Formatter, HP color LaserJet 2550L printer	Table 7-13 on page 269
Q3703-67901	Formatter (includes network card), HP color LaserJet 2550Ln printer and HP color LaserJet 2550n printer	Table 7-13 on page 269
RB1-8668-030CN	Timing belt	Table 7-9 on page 259
RB2-3043-000CN	Bushing, left	Table 7-4 on page 247
RB2-3044-000CN	Bushing, right	Table 7-4 on page 247
RB2-6248-000CN	Damper	Table 7-4 on page 247
RB2-6297-000CN	Rubber foot	Table 7-9 on page 259
RB2-7195-000CN	Roller, transfer sensor	Table 7-9 on page 260
RB2-9809-000CN	Carousel lock, left (white)	Table 7-10 on page 263
RB2-9850-000CN	Mount, terminal	Table 7-9 on page 260
RB2-9851-000CN	Mount, antenna contact	Table 7-9 on page 260
RB2-9852-000CN	Guide, rotary release	Table 7-6 on page 253
RB2-9903-000CN	Cable guide	Table 7-6 on page 253
RB2-9904-000CN	Fuser duct	Table 7-8 on page 257
RB2-9905-000CN	Spring, torsion	Table 7-5 on page 251
RB2-9909-000CN	Roller, lower, top output bin, small	Table 7-8 on page 257
RB2-9916-000CN	Cover, fuser motor	Table 7-8 on page 257
RB2-9924-000CN	Holder, transfer sensor	Table 7-9 on page 260
RB2-9925-000CN	Flag, transfer sensor	Table 7-9 on page 260
RB2-9932-000CN	RFI shield	Table 7-5 on page 251
RB2-9952-000CN	Spring, tray 1 flag	Table 7-4 on page 247
RB2-9954-000CN	Guide, left, paper feed	Table 7-4 on page 248
RB2-9955-000CN	Guide, right, paper feed	Table 7-4 on page 248
RB2-9999-000CN	Spring	Table 7-9 on page 260
RB3-0006-000CN	Holder, fuser connector	Table 7-11 on page 265
RB3-0007-000CN	Insulating sheet	Table 7-11 on page 265
RB3-0009-000CN	Static charge eliminator plate	Table 7-9 on page 259
RB3-0010-000CN	Feed plate	Table 7-9 on page 259
RB3-0011-000CN	Shaft, feed drive	Table 7-9 on page 259

Table 7-15. Numerical parts list (continued)

Part number	Description	Table and page
RB3-0012-000CN	Roller, belt	Table 7-9 on page 259
RB3-0015-000CN	Spring	Table 7-9 on page 260
RB3-0016-000CN	Spring	Table 7-9 on page 259
RB3-0019-000CN	Toner-catch tray	Table 7-5 on page 251
RB3-0022-000CN	Gear, idler, 23T	Table 7-9 on page 259
RB3-0023-000CN	Holder, interlock switch	Table 7-6 on page 253
RB3-0037-000CN	Rod, on/off switch	Table 7-3 on page 245
RB3-0042-000CN	Spring	Table 7-9 on page 259
RB3-0043-000CN	Spring	Table 7-9 on page 259
RB3-0044-000CN	Spring	Table 7-9 on page 259
RB3-0045-000CN	Spring	Table 7-9 on page 259
RB3-0046-000CN	Spring	Table 7-9 on page 259
RB3-0047-000CN	Spring	Table 7-9 on page 259
RB3-0048-000CN	Spring	Table 7-9 on page 259
RB3-0052-000CN	Cover, gear	Table 7-9 on page 259
RB3-0057-000CN	Transfer slide plate	Table 7-9 on page 259
RB3-0060-000CN	Shaft, idler gear	Table 7-9 on page 259
RB3-0061-000CN	Pulley	Table 7-9 on page 259
RB3-0062-000CN	Holder, high-voltage	Table 7-11 on page 265
RB3-0063-000CN	Feed belt	Table 7-9 on page 259
RB3-0065-000CN	Grounding spring	Table 7-9 on page 259
RB3-0066-000CN	Grounding spring	Table 7-9 on page 259
RB3-0067-000CN	Pulley	Table 7-9 on page 260
RB3-0089-000CN	Cover, rack	Table 7-3 on page 245
RB3-0090-000CN	Rack	Table 7-7 on page 255
RB3-0091-000CN	Gear, 18T	Table 7-5 on page 251
RB3-0092-000CN	Gear, 15T	Table 7-5 on page 251
RB3-0104-000CN	Roller cover	Table 7-4 on page 247
RB3-0111-000CN	Flag, tray 1 sensor	Table 7-4 on page 247
RB3-0120-000CN	Cover, solenoid (SL92)	Table 7-4 on page 247
RB3-0121-000CN	Spring, right	Table 7-4 on page 247
RB3-0122-000CN	Spring, left	Table 7-4 on page 247
RB3-0135-000CN	Flag, switch	Table 7-4 on page 247

Table 7-15. Numerical parts list (continued)

Part number	Description	Table and page
RB3-0160-000CN	Pickup roller, tray 1	Table 7-4 on page 247
RB3-0286-000CN	Grounding plate	Table 7-9 on page 259
RB3-1065-000CN	Spring, left	Table 7-8 on page 257
RB3-1088-000CN	Guide, transfer inlet	Table 7-9 on page 260
RB3-1091-000CN	Spring	Table 7-9 on page 260
RB3-1092-000CN	Spring	Table 7-9 on page 260
RB3-1094-000CN	Bushing	Table 7-9 on page 260
RB3-1108-000CN	Front cover	Table 7-4 on page 247
RB3-1110-000CN	Insulating sheet	Table 7-9 on page 259
RB3-1112-000CN	Cover, interface	Table 7-3 on page 245
RB3-1113-000CN	Plate, swing shaft, grounding	Table 7-5 on page 251
RB9-0879-000CN	Carousel lock, right (black)	Table 7-10 on page 263
RB9-0880-000CN	Cover, rear	Table 7-3 on page 245
RB9-0881-000CN	Cover, top output bin	Table 7-3 on page 245
RB9-0884-000CN	DIMM door	Table 7-3 on page 245
RB9-0886-000CN	Cover, left	Table 7-3 on page 245
RB9-0889-000CN	Hinge, left, tray 1	Table 7-4 on page 247
RB9-0890-000CN	Hinge, right, tray 1	Table 7-4 on page 247
RB9-0897-000CN	Front lower cover	Table 7-4 on page 247
RB9-0901-000CN	Air duct	Table 7-5 on page 251
RF5-4012-000CN	Separation pad assembly	Table 7-4 on page 247
RF5-4047-000CN	Pad, light-blocking	Table 7-4 on page 248
RF5-4063-000CN	Gear train motor	Table 7-7 on page 255
RF5-4065-000CN	Entrance guide	Table 7-9 on page 260
RF5-4067-000CN	Roller, transfer	Table 7-9 on page 260
RF5-4068-000CN	Roller, small, top output bin	Table 7-5 on page 251
RF5-4069-000CN	Top door	Table 7-3 on page 245
RG5-6880-000CN	Laser/scanner	Table 7-6 on page 253
RG5-6897-000CN	Roller assembly, upper, top output bin	Table 7-5 on page 251
RG5-6907-000CN	Top plate	Table 7-6 on page 253
RG5-6935-000CN	Cartridge guide assembly	Table 7-6 on page 253
RG5-6938-000CN	Gear assembly	Table 7-4 on page 247
RG5-6939-000CN	Registration roller assembly	Table 7-9 on page 259

Table 7-15. Numerical parts list (continued)

Part number	Description	Table and page
RG5-6940-000CN	Registration shutter assembly	Table 7-9 on page 259
RG5-6942-000CN	Rotary plate assembly, left	Table 7-10 on page 263
RG5-6952-000CN	Tray 1 pickup assembly	Table 7-4 on page 247
RG5-6956-000CN	E-label reader PCA	Table 7-4 on page 247
RG5-6957-000CN	Contact assembly, E-label reader	Table 7-10 on page 263
RG5-6964-000CN	Toner-sensor PCA	Table 7-10 on page 263
RG5-6964-000CN	Toner-sensor PCA	Table 7-13 on page 269
RG5-6966-000CN	Sensor, top-of-page	Table 7-4 on page 248
RG5-6966-000CN	Top-of-page sensor PCA	Table 7-13 on page 269
RG5-6967-000CN	Registration sensor	Table 7-9 on page 260
RG5-6967-000CN	Registration-sensor PCA	Table 7-13 on page 269
RG5-6971-000CN	Cable, fuser, power	Table 7-11 on page 265
RG5-7106-000CN	Cable, formatter, power	Table 7-11 on page 265
RG5-7108-000CN	Cable, power (2)	Table 7-11 on page 265
RG5-7109-000CN	Cable, fuser connector, dc controller	Table 7-11 on page 265
RG5-7114-000CN	Cable, motor	Table 7-6 on page 253
RG5-7115-000CN	Cable, transfer sensor (2nd)	Table 7-7 on page 255
RG5-7117-000CN	Cable, sensor	Table 7-6 on page 253
RG5-7122-000CN	Cable, interface	Table 7-9 on page 259
RG5-7123-000CN	Cable, grounding	Table 7-9 on page 259
RG5-7124-000CN	Sub-high-voltage transformer PCA	Table 7-11 on page 265
RG5-7124-000CN	Sub-high-voltage transformer PCA	Table 7-13 on page 269
RG5-7126-000CN	Cable, sub-high-voltage transformer	Table 7-11 on page 265
RG5-7128-000CN	Cable	Table 7-9 on page 260
RG5-7129-000CN	Cable, rotary assembly	Table 7-10 on page 263
RG5-7130-000CN	Cable, high-voltage transformer	Table 7-9 on page 260
RG5-7145-000CN	Cable, front	Table 7-5 on page 251
RG5-7146-000CN	Cable, high-voltage transformer	Table 7-11 on page 265
RG5-7567-000CN	Cover, top (assembly)	Table 7-3 on page 245
RG5-7569-000CN	Cover, right side (assembly)	Table 7-3 on page 245
RG5-7570-000CN	Control panel assembly	Table 7-3 on page 245
RG5-7571-000CN	Cover, left side (assembly)	Table 7-3 on page 245
RG5-7572-000CN	Fuser, 110-127 V	Table 7-3 on page 245

Table 7-15. Numerical parts list (continued)

Part number	Description	Table and page
RG5-7573-000CN	Fuser, 220-240 V	Table 7-3 on page 245
RG5-7579-000CN	Main drive assembly	Table 7-5 on page 251
RG5-7579-000CN	Main drive assembly	Table 7-6 on page 253
RG5-7579-000CN	Main drive assembly	Table 7-7 on page 255
RG5-7580-000CN	Right side plate rear assembly	Table 7-7 on page 255
RG5-7581-000CN	Right side plate front assembly	Table 7-7 on page 255
RG5-7584-000CN	Tray 1 guide assembly	Table 7-4 on page 247
RG5-7585-000CN	Tray 1 assembly	Table 7-4 on page 247
RG5-7587-000CN	Rotary assembly	Table 7-6 on page 253
RG5-7587-000CN	Rotary (carousel) assembly	Table 7-10 on page 263
RG5-7589-000CN	Rotary pressure assembly	Table 7-10 on page 263
RG5-7592-000CN	Rotary drive assembly	Table 7-6 on page 253
RG5-7592-000CN	Rotary drive assembly	Table 7-12 on page 267
RG5-7593-000CN	Motor (DCM703)	Table 7-12 on page 267
RG5-7595-000CN	Roller, lower, top output bin	Table 7-8 on page 257
RG5-7605-000CN	Dc Controller	Table 7-6 on page 253
RG5-7605-000CN	Dc controller	Table 7-13 on page 269
RG5-7606-000CN	High-voltage transformer PCA	Table 7-11 on page 265
RG5-7606-000CN	High-voltage transformer PCA	Table 7-13 on page 269
RG5-7607-000CN	Sensor, waste toner	Table 7-4 on page 248
RG5-7607-000CN	Waste-toner sensor PCA	Table 7-13 on page 269
RG5-7620-000CN	Cable, fuser motor	Table 7-5 on page 251
RG5-7621-000CN	Cable, power (1)	Table 7-11 on page 265
RG5-7622-000CN	Cable, upper	Table 7-5 on page 251
RG5-7624-000CN	Cable, waste toner sensor	Table 7-4 on page 247
RH2-5519-000CN	Connector, optional trays	Table 7-9 on page 259
RH2-5524-000CN	Cable, flat, flexible, laser/scanner	Table 7-6 on page 253
RH3-2254-000CN	Low-voltage PCA, 110-127 V	Table 7-11 on page 265
RH3-2254-000CN	Low-voltage PCA, 110-127 V	Table 7-13 on page 269
RH3-2255-000CN	Low-voltage PCA, 220-240 V	Table 7-11 on page 265
RH3-2255-000CN	Low-voltage PCA, 220-240 V	Table 7-13 on page 269
RH5-3115-000CN	Resistor	Table 7-9 on page 260
RH7-1533-000CN	Motor, dc, 24 V	Table 7-8 on page 257

Table 7-15. Numerical parts list (continued)

Part number	Description	Table and page
RH7-1535-000CN	Motor (PM705)	Table 7-12 on page 267
RH7-1537-000CN	Fan (FM712)	Table 7-5 on page 251
RH7-1613-000CN	Motor, dc, 24 V	Table 7-5 on page 251
RH7-5335-000CN	Clutch, main gear train (CL2)	Table 7-7 on page 255
RH7-5338-000CN	Solenoid (SL92)	Table 7-4 on page 247
RH7-5340-000CN	Solenoid (SL93)	Table 7-12 on page 267
RH7-5366-000CN	Clutch (CL1)	Table 7-5 on page 251
RH7-6051-000CN	Switch, interlock	Table 7-6 on page 253
RH7-7146-000CN	Sensor, density	Table 7-4 on page 248
RH7-7146-000CN	Density-sensor PCA	Table 7-13 on page 269
RH7-7149-000CN	Thermistor (TH3)	Table 7-5 on page 251
RS5-1635-000CN	Bushing, gear assembly	Table 7-4 on page 248
RS5-1637-000CN	Bushing	Table 7-9 on page 259
RS5-1638-000CN	Bushing	Table 7-4 on page 248
RS6-2030-000CN	Spring, tray 1 guide	Table 7-4 on page 247
RS6-2759-000CN	Spring, on/off switch	Table 7-3 on page 245
RS6-2766-000CN	Spring	Table 7-9 on page 260
RS6-8662-000CN	Label, image cartridge	Table 7-4 on page 248
RS6-8668-000CN	Label, caution	Table 7-5 on page 251
RS7-0418-000CN	Gear, 26T	Table 7-4 on page 247
RS7-0424-000CN	Gear, 20T/40T	Table 7-4 on page 247
RS7-0425-000CN	Gear, 30T	Table 7-4 on page 248
RS7-0426-000CN	Gear, 26T/50T	Table 7-4 on page 247
RS7-0428-000CN	Gear, 30T	Table 7-9 on page 259
RS7-0429-000CN	Gear, 26T	Table 7-4 on page 247
RS7-0435-000CN	Gear, 32T/37T	Table 7-5 on page 251
RS7-0436-000CN	Gear, 37T/43T	Table 7-5 on page 251
RS7-0437-000CN	Gear, 51T	Table 7-5 on page 251
RS7-0570-000CN	Gear, 81T	Table 7-7 on page 255
RS7-0571-000CN	Gear, 23T/54T	Table 7-7 on page 255
RS7-0572-000CN	Gear, 31T/90T	Table 7-7 on page 255
RS7-0573-000CN	Gear, 186T	Table 7-7 on page 255
RS7-0574-000CN	Gear, 32T/123T	Table 7-7 on page 255

Table 7-15. Numerical parts list (continued)

Part number	Description	Table and page
VT2-0012-005CN	Support, high-voltage PCA	Table 7-11 on page 265
WG8-5382-000CN	Sensor (PS718)	Table 7-4 on page 247
WG8-5382-000CN	Sensor, transfer (PS720)	Table 7-9 on page 260
WT2-5056-000CN	Clip, cable	Table 7-4 on page 247
WT2-5700-000CN	Clamp, cable	Table 7-4 on page 247
WT2-5700-000CN	Clamp, cable	Table 7-9 on page 260
WT2-5737-000CN	Clip, cable	Table 7-9 on page 260
WT2-5737-000CN	Clip, cable	Table 7-11 on page 265
XA9-0849-000CN	Screw, RS, M3x6	Table 7-5 on page 251
XA9-0849-000CN	Screw, M3x6	Table 7-6 on page 253
XA9-0849-000CN	Screw, RS, M3x6	Table 7-8 on page 257
XA9-0890-000CN	Screw, RS, M3x6	Table 7-9 on page 260
XA9-1262-000CN	Screw, M4x10	Table 7-4 on page 247
XA9-1262-000CN	Screw, M4x10	Table 7-5 on page 251
XA9-1262-000CN	Screw, M4x10	Table 7-8 on page 257
XA9-1262-000CN	Screw, M4x10	Table 7-9 on page 259
XA9-1291-000CN	Screw, RS, M3x8	Table 7-3 on page 245
XA9-1291-000CN	Screw, M3x8	Table 7-11 on page 265
XA9-1328-000CN	Screw, M3x10	Table 7-5 on page 251
XA9-1355-000CN	Screw, M3x8	Table 7-5 on page 251
XA9-1355-000CN	Screw, M3x8	Table 7-11 on page 265
XD2-1100-322CN	E-ring	Table 7-5 on page 251
XD2-1100-502CN	E-ring	Table 7-4 on page 248

Index

A

- accessories
 - configuration page, printing 226
 - part numbers 239
- adhesive labels
 - loading 39
 - output paths 38
 - specifications 17, 21
- air duct, replacing 127
- Alerts tab, HP LaserJet Toolbox 46
- Apple LaserWriter 8 driver 12
- applications, settings 10
- Attention light
 - locating 35
 - printer status messages 183
 - supplies status messages 180, 181

B

- back cover, replacing 122
- background quality, troubleshooting 194
- bins, output
 - features 5
 - locating 7
- Black print-cartridge light
 - blinking 178, 180
 - locating 34
 - on 177
- blank pages, troubleshooting 210
- brake solenoid 139
- browser requirements 44
- buttons, control panel 34

C

- cables
 - connecting 33
 - Macintosh 215
 - part numbers 239
 - troubleshooting 170
- calibrating printer 63
- Cancel Job button 35
- cardstock 17
- carousel
 - motor, replacing 120
 - replacing 145
 - rotating 216

cartridges

- carousel, replacing 145
- carousel, rotating 216
- high-voltage connection points, checking 219
- life expectancy 51
- non-HP supplies policy 66
- operations 93
- part numbers 239
- recycling 25, 65
- refilled 25
- replacing 103
- status lights 34, 177
- status page, printing 226
- status, checking 64
- storage specifications 16
- storing 65
- toner, washing off clothing 171
- warranty 24

characters, troubleshooting 193, 196

checks

- continuous self-test 218
- engine 218
- high-voltage power supply 219
- paper path 219

Chooser, troubleshooting 213

classes 238

cleaning operations, image formation 90, 92

cleaning page 61

clutches 76, 80

cold reset 221

color, troubleshooting 200

commands, P/L 223

configuration page

- printing 225
- troubleshooting 169

configurations, printer 2

connecting cables 33

connectors, locating 230

consumables. *See* supplies

continuous self-test 218

control panel

- lights and buttons, description 34
- printer status lights 182
- replacing 107
- supplies status lights 177
- supply status, checking 65
- troubleshooting 169

- country/region of origin 7
- Courier font, troubleshooting 212
- coverage, printer 25
- covers
 - back, replacing 122
 - front lower, replacing 121
 - front, replacing 130
 - fuser, replacing 104
 - interface, replacing 110
 - left-side, replacing 106
 - locating 7
 - open, detection operations 77
 - part numbers 245
 - right-side, replacing 106
 - top, replacing 123
- covers, document 17
- curl, troubleshooting 197
- customer support 238
- Cyan print-cartridge light
 - blinking 178, 180
 - locating 34
 - on 177

D

- dc controller
 - connections 233
 - E-label operations 94
 - engine control system 70
 - jam detection operations 77
 - laser/scanner operations 74
 - pickup and feed operations 75
 - replacing 117
 - sequence of operations 70
 - tray operations 76
- declaration of conformity 27
- default settings, restoring 221
- delay jams 77
- delivery delay jams 77
- delivery roller, testing 219
- delivery stationary jams 77
- demo page
 - printing 225
 - troubleshooting 169
- density
 - sensor 130
 - troubleshooting 192
- developer motor 93, 139
- developing rotary detection PCA 94
- developing system operations 84, 86
- Device Settings, HP LaserJet Toolbox 47
- dimensions, printer 15
- DIMMs
 - configuration page, printing 225
 - part numbers 239
- documentation 46
- Documentation tab, HP LaserJet Toolbox 46
- door open detection 77

- door, replacing 125
- DOS Command Prompt 223
- dots per inch (dpi), specifications 4
- downloading drivers 10
- dpi (dots per inch), specifications 4
- drive roller 219
- drivers
 - downloading 10
 - Macintosh 12
 - operating systems supported 9
 - uninstalling 13
 - Windows, features 11
- dropouts, troubleshooting 193
- drum, imaging
 - cleaning operations 93
 - E-label 94, 132
 - life expectancy 51
 - non-HP supplies policy 66
 - operations 74, 84, 86
 - replacing 103
 - status light 35, 178
 - status page, printing 226
 - status, checking 64
 - storing 65
 - warranty 24

E

- E-label
 - operations 93, 94
 - removing 132
- ECU pan, replacing 154
- electrical specifications 15
- electrostatic discharge (ESD) 99
- encoder motor 139
- energy consumption 15
- engine control system 70
- engine test
 - performing 218
 - troubleshooting 169
- envelopes
 - loading 39
 - output paths 38
 - specifications 17, 20
- environmental specifications
 - paper 19
 - printer 16, 32
- error messages
 - event log 226
 - Low cartridge 64, 177
 - Macintosh 204
 - printer status lights 182
 - supplies status lights 177
 - Windows 204
- ESD (electrostatic discharge) 99
- event log 226
- Explorer, versions supported 44

- F**
- factory defaults, restoring 221
- faded print, troubleshooting 192
- fans
 - diagrams 73
 - replacing 127
- features 2
- feed-drive shaft, replacing 153
- fonts
 - included 5
 - troubleshooting 212, 215
- formatter
 - PJL commands 223
 - replacing 113
- formatter cage, replacing 111
- fraud hotline 66
- front cover, replacing 130
- front frame assembly, diagrams and part numbers 246
- front lower cover, replacing 121
- fuser
 - control circuit 70
 - diagram 84
 - life expectancy 51
 - operations 89
 - replacing 104
 - roller, testing 219
 - wrap sensor, replacing 161
- fuser motor
 - diagrams 75
 - replacing 116
- fusing delivery paper sensor (PS1) 75, 77
- G**
- gear assembly, replacing 136
- gear-train motor (DCM701) 76
- Go light/button
 - locating 36
 - status 183
- gray background, troubleshooting 194
- H**
- heavy paper specifications 17
- high-voltage power supply
 - locating 70
 - replacing 158
 - troubleshooting 219
- HP Customer Care Online 238
- HP fraud hotline 66
- HP LaserJet Toolbox
 - accessing 236
 - calibrating printer 63
 - cleaning page, printing 61
 - device settings 47
 - operating systems supported 9
 - using 44
- HP Technical Training 238
- HP Web Jetadmin
 - operating systems supported 9
 - using 11
- humidity specifications
 - paper, storing 19
 - printer environment 16
- I**
- IBM OS/2 support 9
- image formation
 - developing stage 86
 - engine control system 70
 - fusing stage 89
 - laser beam operations 86
 - primary charging stage 85
 - separation stage 89
 - stages 85
 - system components 84
 - transfer stage 87
- image quality
 - color, troubleshooting 200
 - specifications 4
 - troubleshooting 190, 199
- images, repeated 199
- imaging drum
 - cleaning operations 93
 - E-label 94, 132
 - life expectancy 51
 - non-HP supplies policy 66
 - operations 74, 84, 86
 - replacing 103
 - status light 35, 178
 - status page, printing 226
 - status, checking 64
 - storing 65
 - warranty 24
- information pages
 - printing 225
 - troubleshooting 169
- input trays. *See* trays
- installing printer 32
- interface cover, replacing 110
- interface ports
 - cables 239
 - connecting to 33
 - locating 7
 - Macintosh issues 215
 - troubleshooting 170
 - types included 5
- internal components, diagrams and part numbers
 - printer 251
- Internet Explorer, versions supported 44
- INTR (initial rotation) sequence 71
- ITB cleaning operations 84, 90, 92

J

- jams
 - causes of 171
 - detection operations 77
 - input, clearing 172
 - internal, clearing 171
 - locations 171
 - output, clearing 174
- Jetadmin
 - operating systems supported 9
 - using 11

K

- keys, control panel 34

L

- labels
 - loading 39
 - output paths 38
 - specifications 17, 21
- languages, printer 5
- laser beam operations 86
- laser safety statements 28
- laser/scanner
 - engine control system 70
 - operations 74
 - replacing 128
- LaserWriter 8 driver 12
- latent image formation 74, 84
- left-side cover, replacing 106
- life expectancies
 - recycling used print cartridges 25
 - supplies 50
- light print, troubleshooting 192
- lights, control panel
 - locating 34
 - printer status 182
 - supplies status 177
 - troubleshooting 169
- Limit Check Error 204
- lines, troubleshooting 193
- LINUX support 9
- loading media
 - tray 1 39
 - tray 2 40
 - tray 3 42
- loose toner, troubleshooting 195
- Low cartridge message 64, 177
- low-voltage power supply
 - locating 70
 - replacing 159
 - troubleshooting 206
- LSTR (last rotation) sequence 71

M

- Macintosh
 - error messages 204, 213
 - features supported 9
 - software features 12
 - uninstalling software 14
- Magenta print-cartridge light
 - blinking 179, 181
 - locating 34
 - on 177
- mailing labels
 - loading 39
 - output paths 38
 - specifications 17, 21
- main motor 75
- maintenance
 - cleaning 61
 - life expectancies of supplies 50
- manual-feed errors 184
- manuals 46
- margins, envelopes 20
- media
 - curl, troubleshooting 197
 - envelopes 20
 - labels 21
 - loading tray 1 39
 - loading tray 2 40
 - loading tray 3 42
 - output paths 38
 - path check 219
 - selecting 18
 - skew, troubleshooting 197
 - specifications 17, 19
 - transparencies 22
 - tray 1, types supported 17
 - troubleshooting 208
 - wrinkled, troubleshooting 198
- media jams. *See* jams
- memory
 - configuration page, printing 225
 - included 2
 - part numbers 239
 - resetting 221
- messages
 - event log 226
 - Low cartridge 64, 177
 - Macintosh 204
 - printer status lights 182
 - supplies status lights 177
 - Windows 204
- middle frame assembly, diagrams and part numbers 258
- model number 7
- models
 - trays included 37
- models, features 2

- motors
 - carousel-engagement, replacing 120
 - diagrams 73
 - fuser, replacing 116
 - print cartridge 93
 - replacing 139
 - testing 219
 - tray 2 and 3 76
- MS-DOS Command Prompt 223

N

- Netscape Navigator, versions supported 44
- networks
 - software for 11
 - troubleshooting 207
- non-HP supplies 66
- non-volatile memory
 - PJL commands 223
 - resetting 221
- NVRAM
 - PJL commands 223
 - resetting 221

O

- on/off switch 7
- on/off switch, replacing 109
- online support 238
- operating environment specifications 32
- operating environment, specifications 16
- operating systems supported 9
- operations
 - clutches 80
 - E-label 94
 - engine control system 70
 - fans 73
 - image formation process 85
 - image formation system 84
 - jam detection 77
 - motors 73
 - paper trays 76
 - pickup and feed system 75
 - power-on 72
 - print cartridges 93
 - printed circuit assemblies (PCAs) 82
 - sensors and switches 78
 - sequences 70
 - solenoids 80
 - timing chart 228
- ordering
 - parts 238
 - supplies 65, 238
- OS/2 support 9

- output bins
 - features 5
 - jams, clearing 174
 - locating 7
 - troubleshooting 210
 - using 38
- output quality
 - color, troubleshooting 200
 - specifications 4
 - troubleshooting 190, 199

P

- page skew, troubleshooting 197
- pages per minute 4
- paper
 - curl, troubleshooting 197
 - loading tray 1 39
 - loading tray 2 40
 - loading tray 3 42
 - output paths 38
 - path check 219
 - selecting 18
 - skew, troubleshooting 197
 - specifications 17, 19
 - tray 1, types supported 17
 - troubleshooting 208
 - wrinkled, troubleshooting 198
- paper input trays. *See* trays
- paper jams. *See* jams
- paper output bins
 - features 5
 - locating 7
- paper-top sensor, replacing 160
- parallel port
 - connecting to 33
 - locating 7
 - troubleshooting 170
 - type included 5
- parts
 - ordering 238
 - removing and replacing 99, 101
- paused printing 36
- PCAs (printed circuit assemblies) 82, 268
- PCL drivers
 - backward compatibility 11
 - features 5
 - operating systems supported 9
- PDEs, Macintosh 12
- personalities 5
- phone numbers
 - fraud hotline 66
 - supplies ordering 238
- photosensors
 - density, replacing 130
 - diagrams 78
 - fuser-wrap, replacing 161
 - jam detection 77

- paper-top, replacing 160
 - pickup and feed system 75
 - top-of-page, replacing 130
 - tray 2 and 3 76
 - waste toner, replacing 138
 - physical specifications 32
 - pickup and feed system
 - engine control system 70
 - operations 75
 - pickup delay jams 77
 - pickup rollers
 - life expectancies 51
 - testing 219
 - tray 1, replacing 52
 - tray 2, replacing 162
 - tray 3, replacing 163
 - pickup stationary jams 77
 - PJL commands 223
 - platforms supported 9
 - ports
 - cables 239
 - connecting to 33
 - locating 7
 - Macintosh issues 215
 - troubleshooting 170
 - types included 5
 - postscript emulator
 - features 5
 - operating systems supported 9
 - PostScript errors 212
 - power
 - requirements 15
 - switch 7
 - troubleshooting 169, 206
 - power supplies
 - base assembly, diagrams and part numbers 264
 - high-voltage, replacing 158
 - locating 70
 - low-voltage, replacing 159
 - operations 72
 - sub-high-voltage, replacing 157
 - power switch, replacing 109
 - PPDs, Macintosh 12
 - primary charging stage, image formation 85
 - primary transfer roller 88
 - print cartridges
 - carousel, replacing 145
 - carousel, rotating 216
 - high-voltage connection points, checking 219
 - life expectancy 51
 - non-HP supplies policy 66
 - operations 93
 - part numbers 239
 - recycling 25, 65
 - refilled 25
 - replacing 103
 - status lights 34, 177
 - status page, printing 226
 - status, checking 64
 - storage specifications 16
 - storing 65
 - toner, washing off clothing 171
 - warranty 24
 - print quality
 - color, troubleshooting 200
 - specifications 4
 - troubleshooting 190, 199
 - PRINT sequence 71
 - printed circuit assemblies (PCAs) 82, 268
 - printer drivers
 - downloading 10
 - Macintosh 12
 - operating systems supported 9
 - uninstalling 13
 - Windows, features 11
 - Printer Job Language (PJL) commands 223
 - printer languages 5
 - printer, cleaning 61
 - printing, troubleshooting 170, 209
 - production code 7
 - programs, settings 10
 - PS emulator
 - features 5
 - operating systems supported 9
 - PS errors 212
- Q**
- quality
 - color, troubleshooting 200
 - specifications 4
 - troubleshooting 190, 199
- R**
- Readme 46
 - Ready light
 - locating 36
 - status 182
 - rear frame assembly, diagrams and part numbers 256
 - rear output door
 - features 5
 - jams, clearing 174
 - locating 7
 - using 38
 - recycling
 - print cartridges 25
 - supplies 65
 - refilled print cartridges 25
 - registration clutch (CL1) 76
 - registration sensor (PS711) 75, 77
 - registration-roller assembly, replacing 150
 - regulatory statements 27
 - removing parts 99, 101
 - repetitive defects, troubleshooting 195, 199, 227

- replacement intervals
 - recycling used print cartridges 25
- replacement intervals, supplies 51
- replacing parts 99, 101
- reports. See information pages
- resetting NVRAM 221
- residual paper jam detection 77
- resolution, specifications 4
- restoring factory defaults 221
- resuming printing 36
- revision level 7
- right-side cover, replacing 106
- roller engaging clutch (CL2) 76
- rollers
 - life expectancies 51
 - pickup, replacing 52
 - primary charging 85
 - registration assembly, replacing 150
 - testing 219
 - transfer 87, 152
 - transfer belt cleaning 90
 - transfer plate, replacing 152
 - tray 2 pickup, replacing 162
 - tray 3 pickup, replacing 163
- rotary assembly, diagrams and part numbers 262
- rotary-drive assembly
 - diagrams and part numbers 266
 - replacing 139
- Rotate Carousel button
 - locating 35, 36
 - using 216

S

- screwdrivers 100
- screws, replacing 99
- secondary transfer roller 88
- sensors
 - density, replacing 130
 - diagrams 78
 - fuser-wrap, replacing 161
 - jam detection 77
 - paper-top, replacing 160
 - pickup and feed system 75
 - top-of-page, replacing 130
 - tray 2 and 3 76
 - waste toner, replacing 138
- separation pads
 - life expectancies 51
 - tray 1, replacing 52, 135
 - tray 2 or 3, replacing 57
 - tray 2, replacing 57
- separation stage, image formation 89
- serial number 7
- setting up printer 32
- settings
 - changing 10
 - configuration page, printing 225
 - restoring factory defaults 221
- side covers 106
- size, printer 15
- skew, troubleshooting 197
- slow printing, troubleshooting 207
- smear toner, troubleshooting 194
- software
 - downloading 10
 - Macintosh, features 12
 - operating systems supported 9
 - Toolbox 44
 - troubleshooting 170
 - uninstalling 13
 - Windows, features 11
- solenoids
 - diagrams 80
 - testing 219
 - tray 1 75
 - tray 2 and 3 76
- space requirements 32
- special media
 - envelopes 20
 - labels 21
 - loading 39
 - output paths 38
 - specifications 17
 - transparencies 22
- specifications
 - envelopes 20
 - environmental 16, 32
 - labels 21
 - media 17
 - model and serial number 7
 - output paths 38
 - paper 19
 - printer 15
 - printer features 4
 - transparencies 22
 - trays, media supported 17
- speed
 - specifications 4
 - troubleshooting 207
- static precautions 99
- stationary jams 77
- status
 - non-HP supplies 66
 - page, printing 226
 - supplies, checking 64
 - viewing with HP LaserJet Toolbox 45
- status lights
 - locating 34
 - printer 182
 - supplies 177
 - troubleshooting 169

- Status tab, HP LaserJet Toolbox 45
- STBY (standby) sequence 70
- storing
 - envelopes 20
 - paper 19
 - printer 16
 - supplies 65
- sub-high-voltage transformer PCA, replacing 157
- supplies
 - fraud hotline 66
 - life expectancies 50
 - non-HP 66
 - ordering 65, 238
 - recycling 65
 - specifications 15
 - status lights 34, 177
 - status page, printing 226
 - status, checking 64
 - storing 65
- support 238
- switches
 - diagrams 78
 - door interlock (SW301) 219
 - engine test 218
 - power 109
- T**
- technical support 238
- Technical Training, HP 238
- telephone numbers
 - fraud hotline 66
 - supplies ordering 238
- temperature specifications
 - paper, storing 19
 - printer environment 16
- tests
 - continuous self 218
 - engine 218
 - high-voltage power supply 219
 - paper path 219
- text, troubleshooting 193, 196, 211
- timing chart 228
- toner
 - developing stage operations 86
 - level detection PCA 94
 - scatter, troubleshooting 198
 - smear, troubleshooting 194
 - specks, troubleshooting 192
 - status lights 34
 - transfer operations 87
 - washing off clothing 171
 - waste cleaning operations 90, 92, 93
- toner cartridges. See print cartridges
- toner-catch tray, removing 151
- Toolbox
 - using 44
- Toolbox, HP
 - accessing 236
 - calibrating printer 63
 - cleaning page, printing 61
 - device settings 47
 - operating systems supported 9
 - using 44
- tools, required 100
- top cover
 - locating 7
 - open, detection operations 77
 - replacing 123
- top door, replacing 125
- top output bin
 - features 5
 - jams, clearing 174
 - locating 7
 - troubleshooting 210
 - using 38
- top plate, replacing 142
- top-of-page sensor, replacing 130
- transfer belt cleaning operations 90
- transfer belt operations
 - charging 88
 - cleaning 90, 92
 - separating 89
- transfer operations, image formation 84, 87
- transfer roller
 - life expectancy 51
 - replacing 152
 - testing 219
- transfer roller plate, replacing 152
- transparencies
 - loading 39
 - output paths 38
 - specifications 17, 22
- tray 1
 - default selection 37
 - error messages 184
 - loading media 39
 - locating 7
 - replacing 133
 - sensors 75
 - separation pad, replacing 135
 - solenoids 75
 - troubleshooting 208
- tray 2
 - default selection 37
 - error messages 184
 - jams, clearing 172
 - loading media 40
 - locating 7
 - models including 37
 - operations 76
 - pickup roller, replacing 162

- replacing 118
- separation pad, replacing 51, 57
- size specifications 15
- troubleshooting 208
- tray 3
 - default selection 37
 - error messages 184
 - jams, clearing 172
 - loading media 42
 - locating 7
 - models including 37
 - operations 76
 - pickup roller, replacing 163
 - separation pad, replacing 51, 57
 - size specifications 15
 - troubleshooting 208
- trays
 - default selection 37
 - error messages 184
 - features 5
 - included 2
 - jams, clearing 172
 - locating 7
 - media supported 17
 - models including 37
 - operations 76
 - replacing 118, 133
 - specifications 17
 - toner-catch, removing 151
 - troubleshooting 208
- troubleshooting
 - basic steps 169, 206
 - blank pages 210
 - color 200
 - control panel 169
 - curl 197
 - engine test 218
 - error messages 204
 - fonts 212, 215
 - gray background 194
 - high-voltage power supply 219
 - HP LaserJet Toolbox 236
 - image quality 190, 199
 - information pages 170, 225
 - light print 192
 - lines 193
 - Macintosh issues 213
 - networks 207
 - output bins 210
 - paper path check 219
 - PostScript (PS) errors 212
 - power 169, 206
 - printer status lights 182
 - printing 170, 209
 - repetitive defects 195, 199, 227
 - resetting NVRAM 221
 - skew 197
 - slow printing 207
 - software 170
 - supplies status lights 177
 - tests 218
 - text 193, 196, 211
 - toner specks or smear 192, 194, 198
 - wiring diagrams 234
 - wrinkled pages 198
- Troubleshooting tab, HP LaserJet Toolbox 45
- TrueType fonts, included 5

U

- uninstalling software 13
- UNIX support 9
- USB port
 - connecting to 33
 - locating 7
 - Macintosh issues 215
 - troubleshooting 170
 - type included 5
- user-replaceable parts
 - life expectancies 50
 - pickup roller and separation pad 52
 - tray 2 separation pad 57

V

- voltage requirements 15

W

- WAIT sequence 70
- warranty
 - product 23
 - refilled cartridges, impact on 25
- waste toner
 - cleaning operations 90, 92
 - drum cleaning 93
 - sensor, replacing 138
- wave, troubleshooting 197
- Web browser requirements 44
- Web Jetadmin
 - operating systems supported 9
 - using 11
- Web sites
 - HP Web Jetadmin 11
 - parts ordering 238
- weight
 - paper specifications 17
 - printer 15
- Windows
 - error messages 204
 - uninstalling software 13
 - versions supported 9
- wire harnesses, replacing 99
- wiring diagrams 234
- wrap jam sensor (PS720) 75
- wrinkled pages, troubleshooting 198

Y

Yellow print-cartridge light
 blinking 179, 181
 locating 34
 on 177



i n v e n t

© 2004 Copyright Hewlett-Packard Development Company, LP

www.hp.com



Q3702-90923